

HP-3 Wall Mount Direct Installation Instructions

Step 1 - Feed & Mounting Locations

J-Box & Feed Location

- Position luminaire on wall in desired location.
- Mark the top corner of the luminaire, not including the endcap. This is Point A.
Use Point A to find and mark feed location.
- Use feed location to center and install 2x4 (single-gang) J-Box.
- Position and install starter wall rail. (See page 3.)

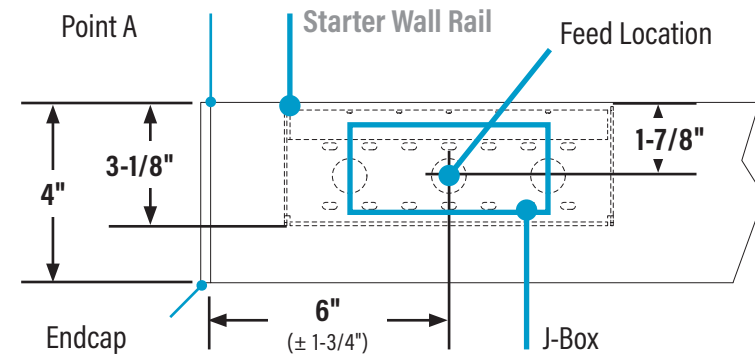

Mounting Locations

X = Luminaire section length
(X Measurements **do not include** endcaps)

- Position wall rails as indicated to the right.
- Center of starter wall rail is 6" (± 3/4") from Point A.
- Ensure wall rail mounts are secured to proper structural support.

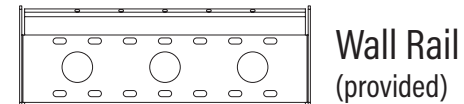
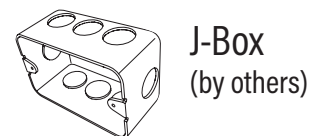
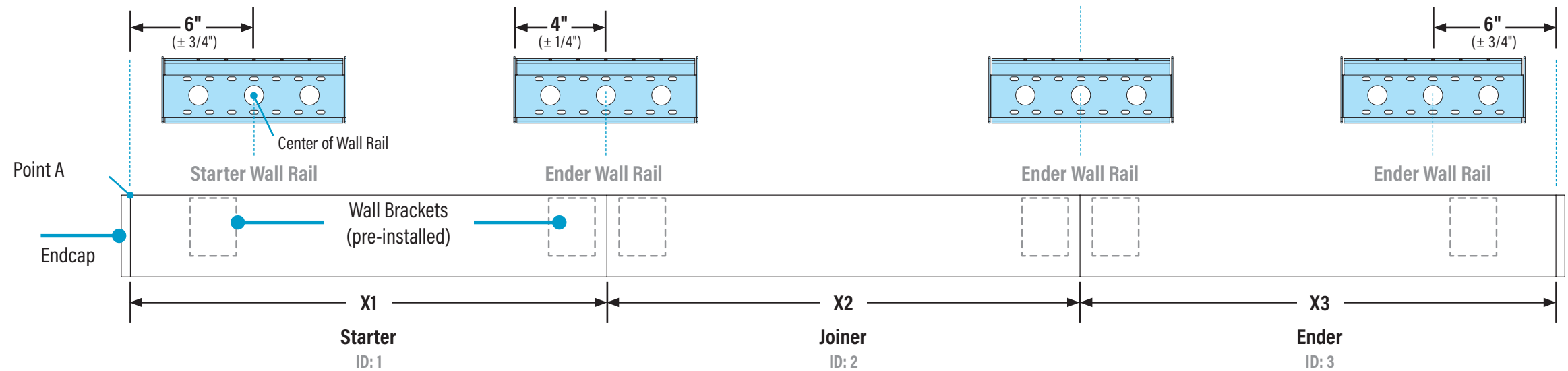

CONTINUED

HP-3 Wall Mount Direct Installation Instructions

Step 1 - Feed & Mounting Locations

A. Mount Wall Rail & Power Feed

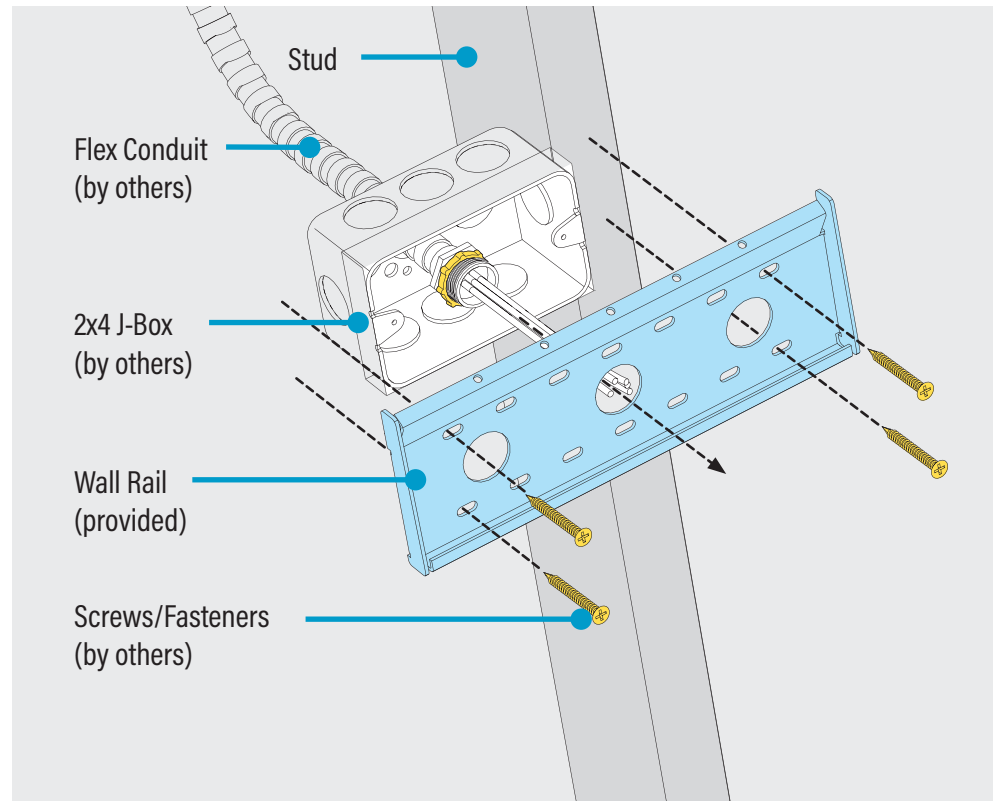

Alternate Mounting Method

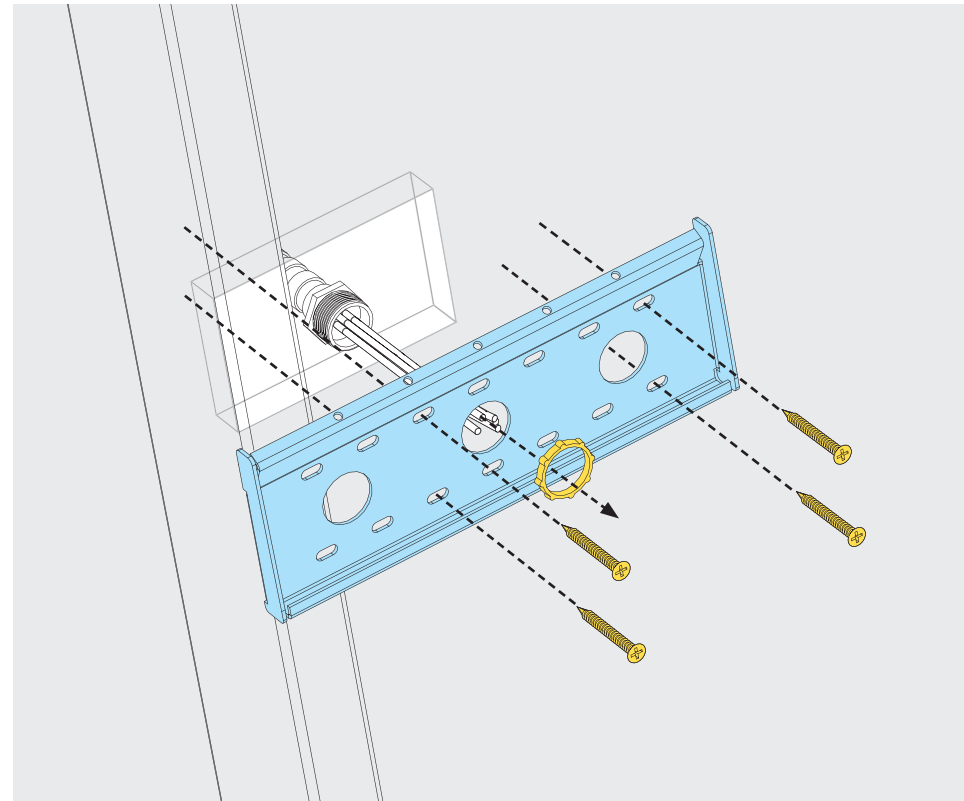

B. Level Wall Rails

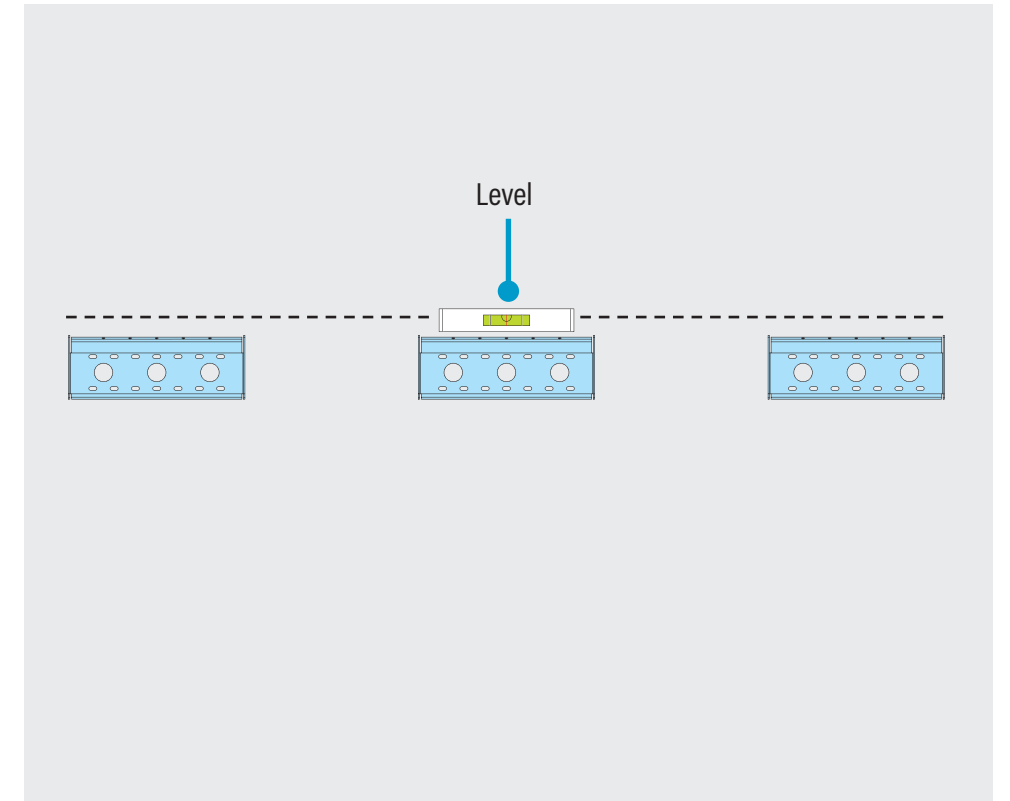

- Use feed location to center and install 2x4 (single-gang) J-Box.
- Level wall rail to ensure proper mounting.
- Install screws through rail and into proper structure support.

- Install all wall rails, ensuring they are level with each other.

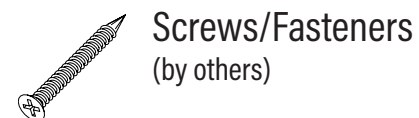
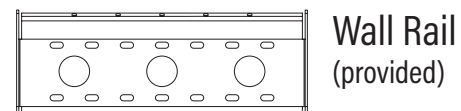
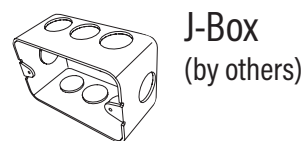

HP-3 Wall Mount Direct Installation Instructions

Step 2 - Identification & Preparation

A. Identify Luminaires

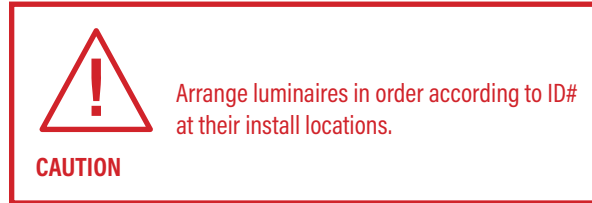

Arrange luminaires in order according to ID# at their install locations.

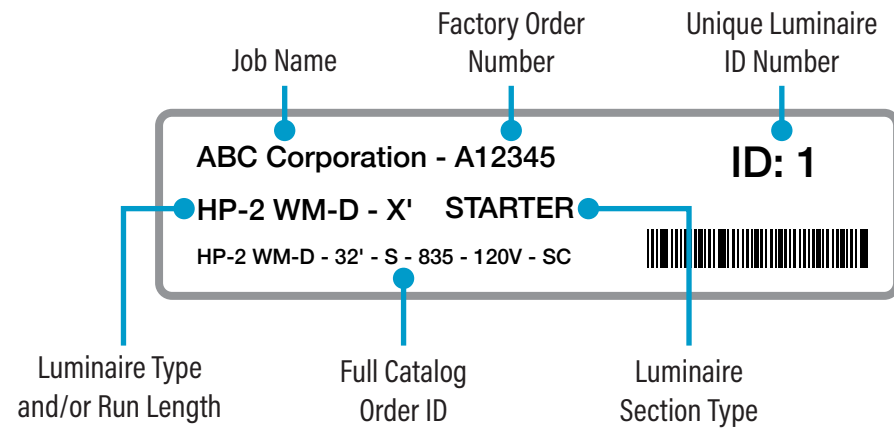

- Identify all luminaires by their ID label that can be found on the box, the diffuser, and inside the luminaire.
- **NOTE:** Exact location of labels in these areas may vary.
- Remove all luminaires from their box.
- Refer to Record Drawings that can be found in the hardware kit.

B. Remove Diffusers or Louvers

Remove Diffusers

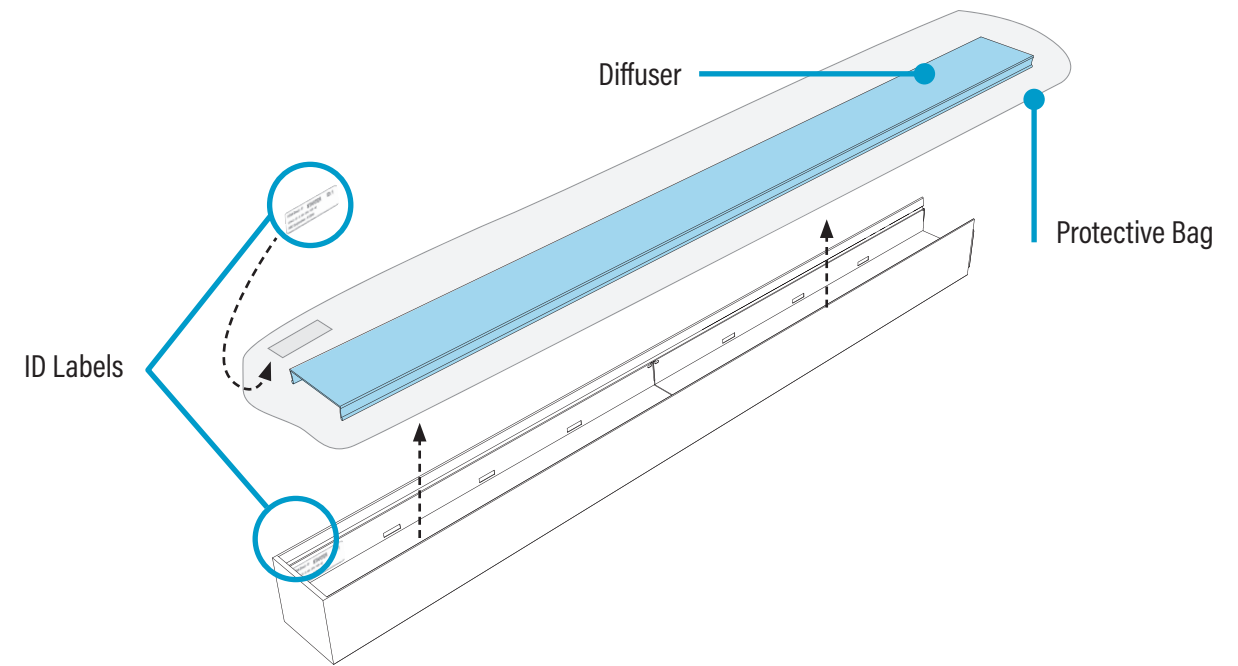

- Carefully remove all diffusers, keeping them inside their protective bags.
- Set aside all diffusers to prevent from getting dirty or damaged.
- Ensure diffusers can be clearly identified back to their corresponding luminaire.

Kitted Hardware

- Finelite has provided items listed here, with their Finelite part numbers. These items can be found in separate boxes shipped with the luminaire.
- Account for all parts and set aside until they are needed.
- All other hardware needed for this installation will be by others.

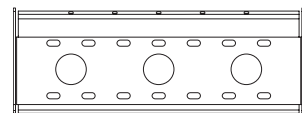

Wall Rail
Part# 20081
Feed & Mounting Locations
pp. 2-3, Step 1



#8-18 x 1/4" Mounting Screw
Part# 94059
Mounting Starter to Structure
p. 5, Step 3
Closing Luminaires
p. 9, Step 7

HP-3 Wall Mount Direct Installation Instructions

Step 3 - Mounting Starter to Structure

A. Mount Starter to Structure

WIRING LEGEND		
Black	Hot	Line Voltage
White	Neutral	Line Voltage
Green	Ground	
Pink	Dimming	0-10V DC
Purple	Dimming	0-10V DC

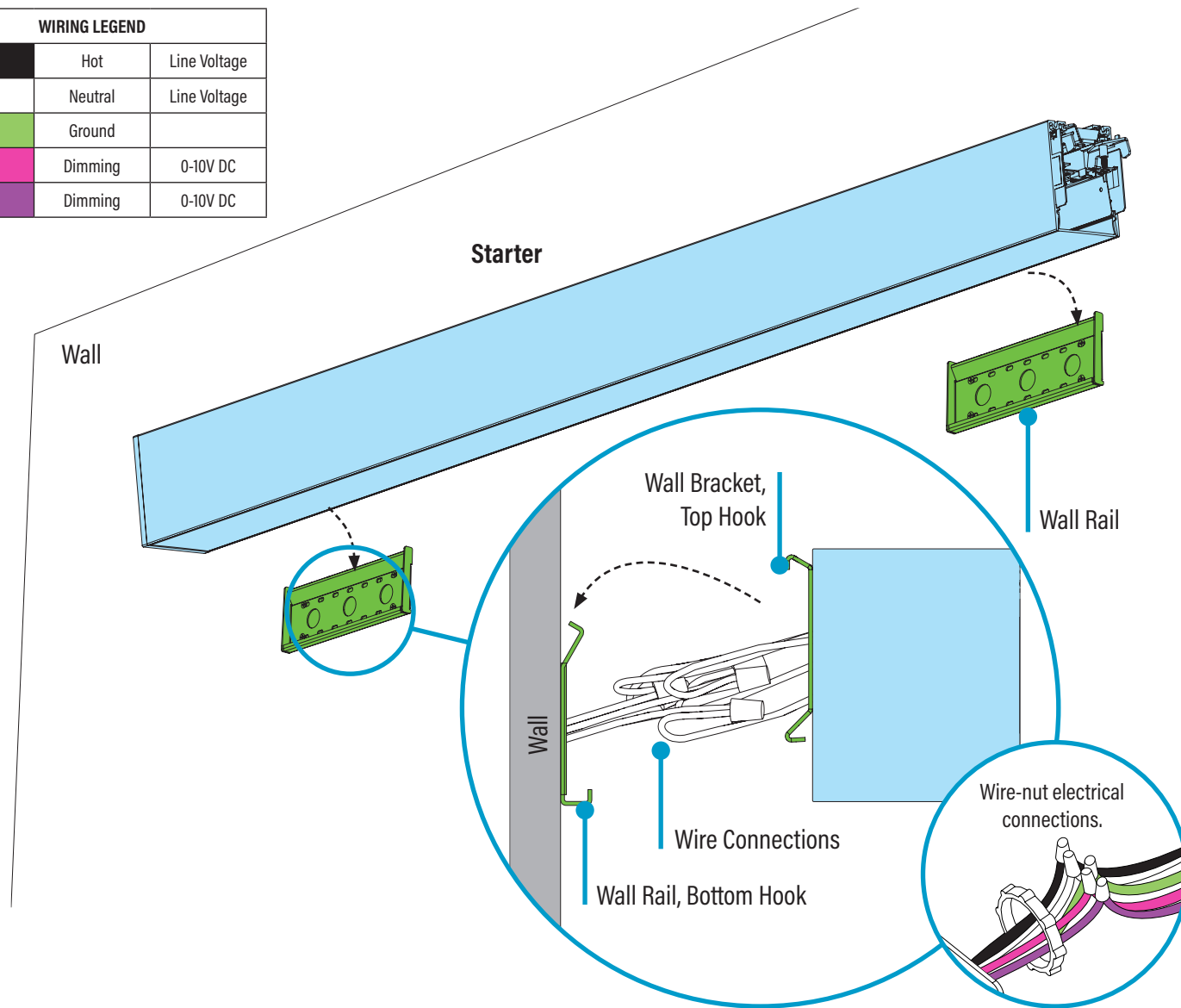

- While properly supporting luminaire, make electrical connections and push complete connections into J-Box.
- Position starter luminaire in place so that the top and bottom hooks of the wall bracket engage with the top and bottom hooks of the wall rail.

B. Secure Starter to Wall Rail

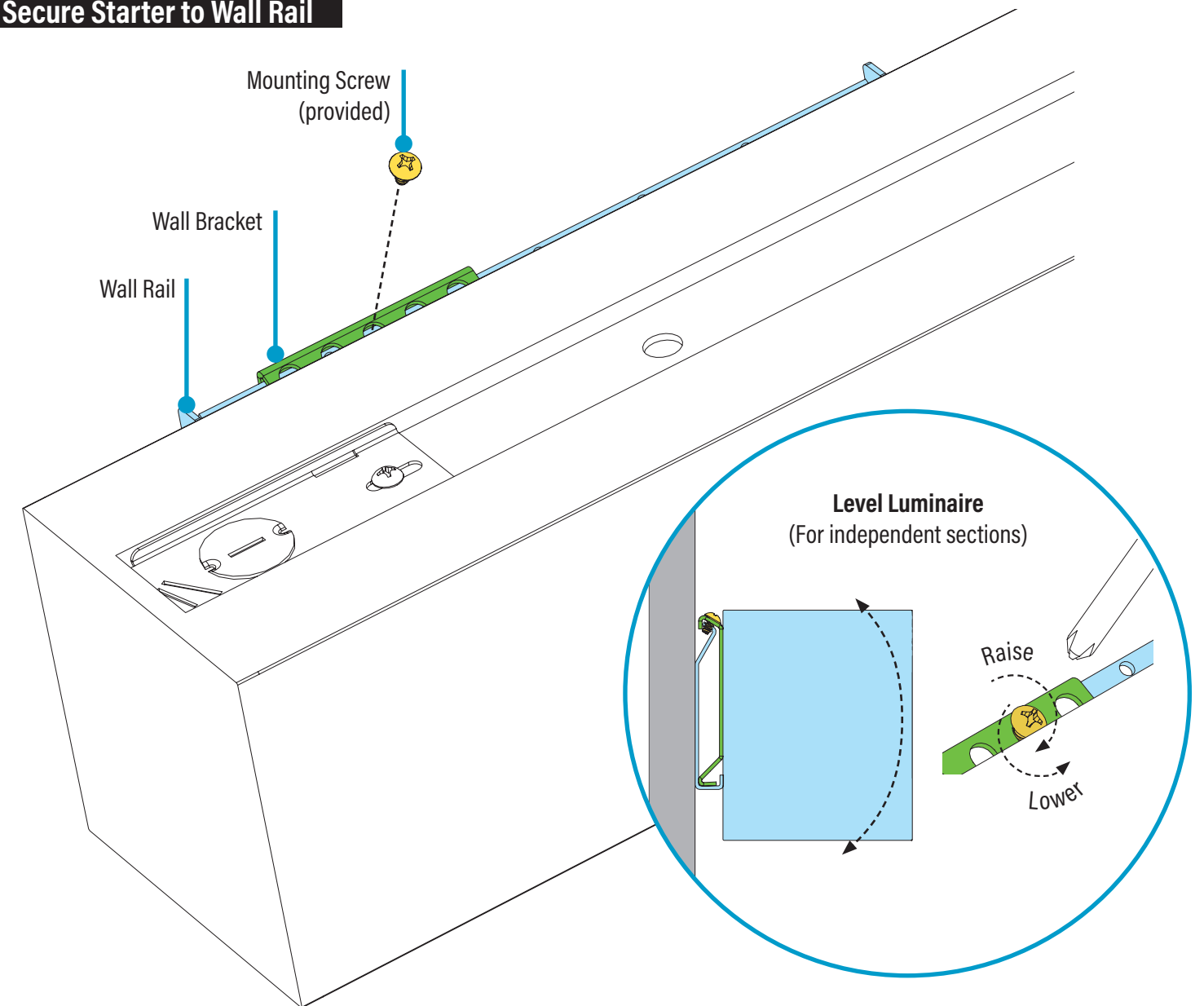

- If there is no joiner/ender, then secure starter luminaire to wall rail with a mounting screw and perform leveling. Tightening the screw raises and loosening the screw lowers the front edge of the luminaire. **PROCEED TO STEP 6, B.**
- If continuing with a joiner luminaire, do not perform leveling yet. **PROCEED TO STEP 4.**

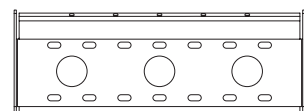

Wall Rail
(provided)



Mounting Screw
#8-18 x 1/4" (provided)



0-10V
Dimming

HP-3 Wall Mount Direct Installation Instructions

Step 4 - Joining Luminaires

A. Mount Joiner/Ender to Structure



CAUTION

DO NOT attempt to join luminaires together on the floor. Damage may result when lifted. Follow these instructions.

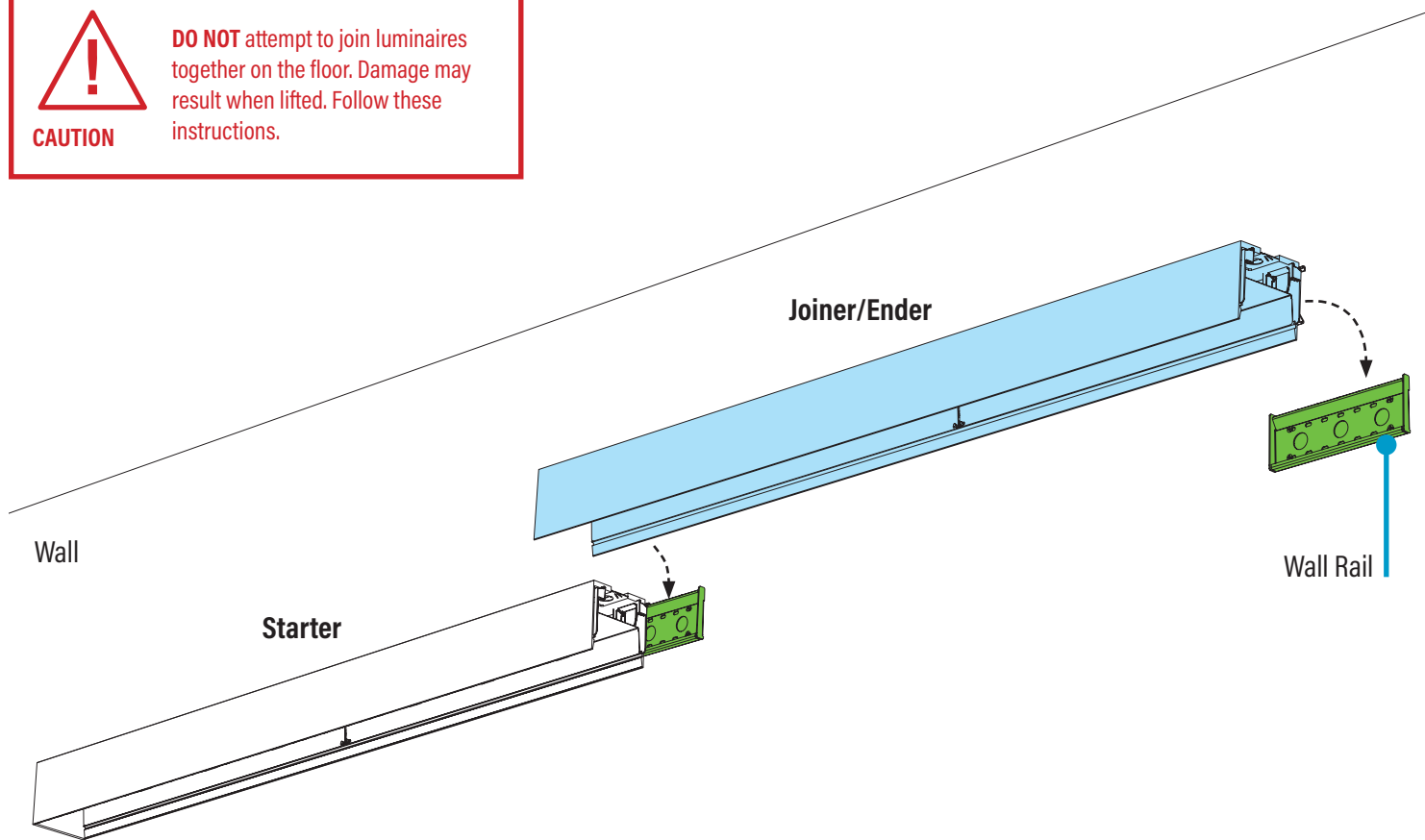

- Maneuver joiner/ender luminaire to wall and engage top and bottom hooks of the wall bracket with the top and bottom hooks of the wall rail.

B. Make Electrical Connections

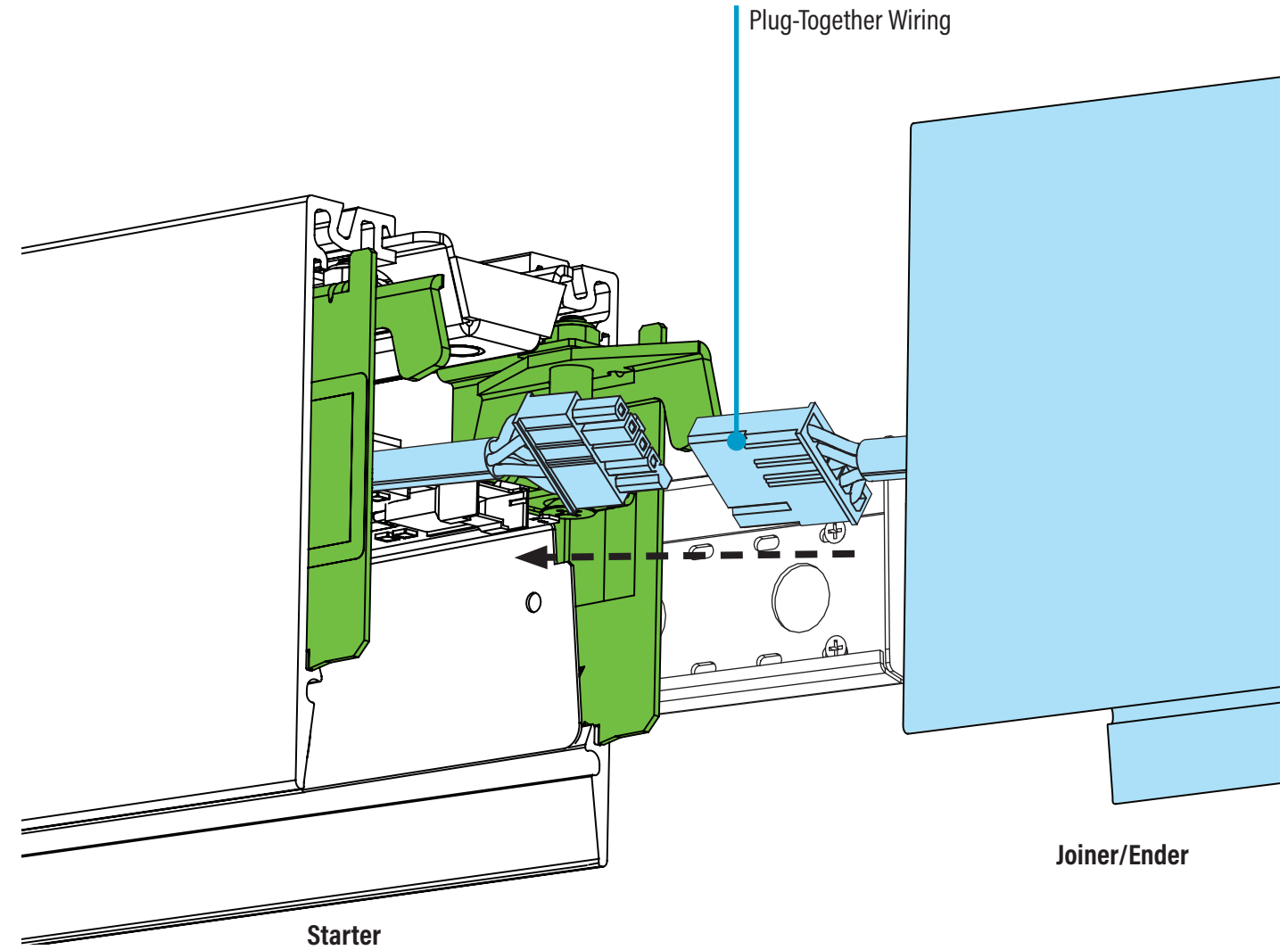

- Connect plug-together wiring.

HP-3 Wall Mount Direct Installation Instructions

Step 5 - Securing Luminaire Joints

A. Join Luminaires

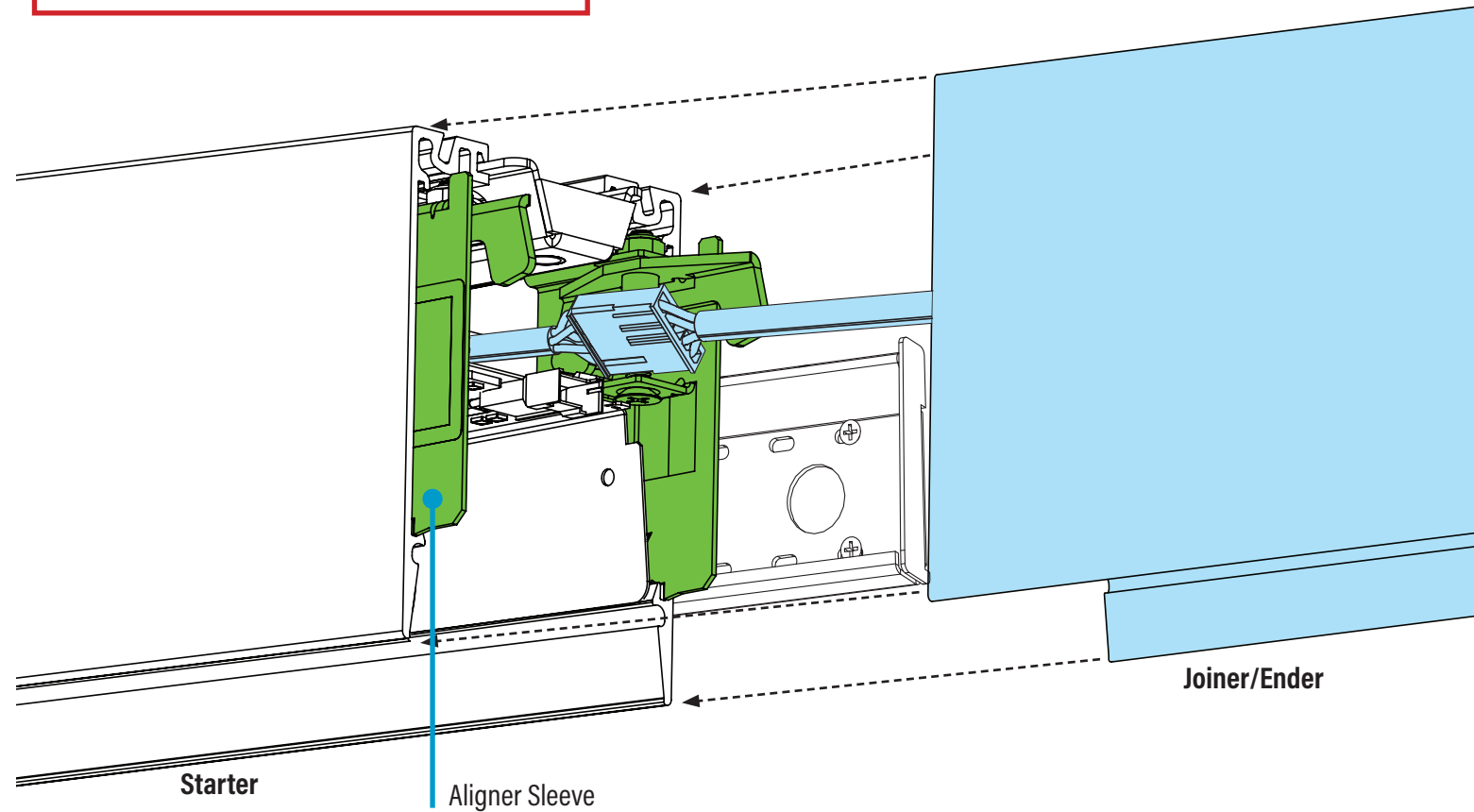

- Align joiner/ender luminaire with aligner sleeves on the starter and slide together. Be careful not to damage any wiring.
- If necessary, lift both luminaires, then slide together.

B. Secure Easy Joint

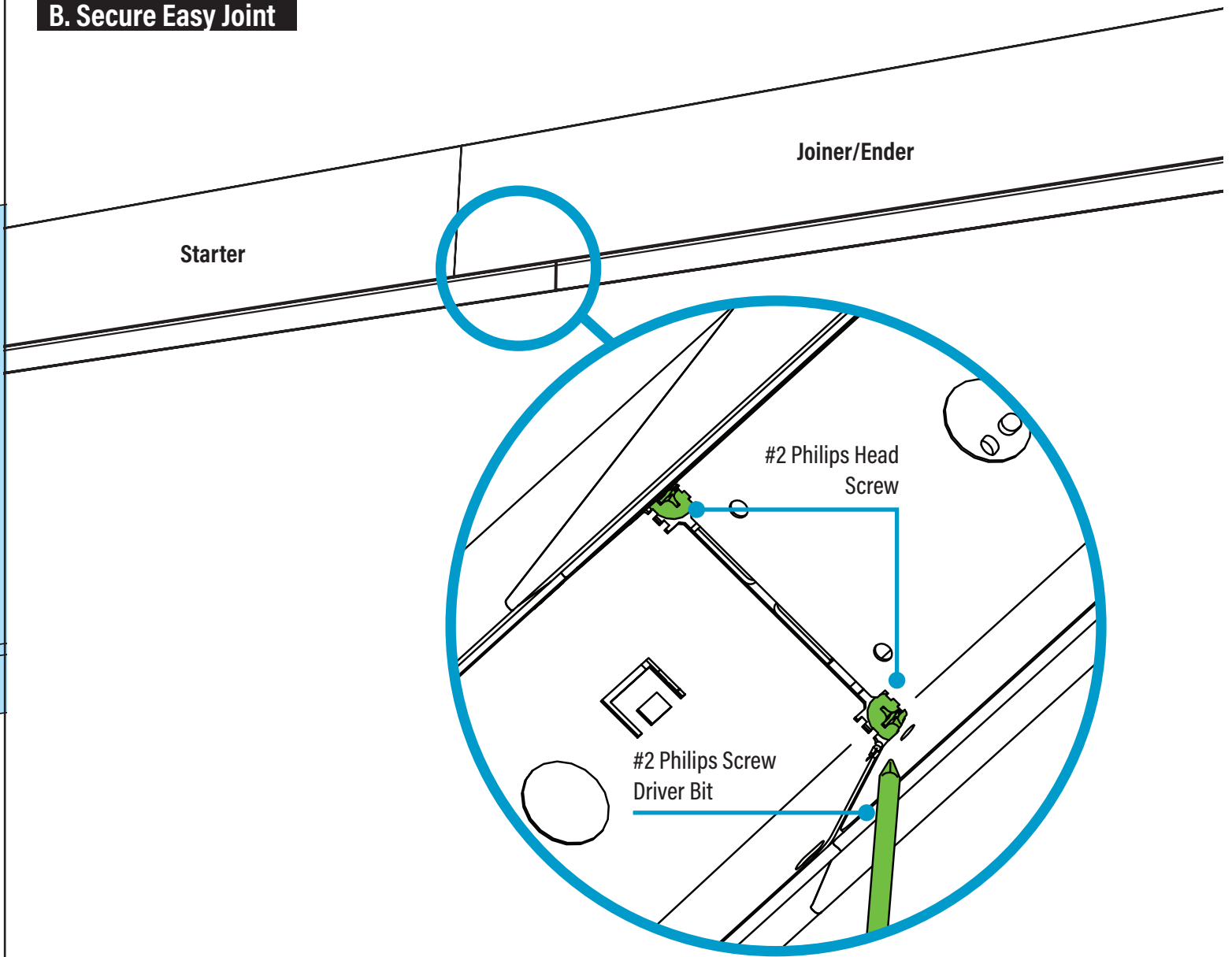

- Secure Joiner/Ender with Starter by tightening two #2 Philips Head Screws.
- Tighten two screws simultaneously and apply equal pressure to each one until tightened.
- **DO NOT USE impact drivers. Only use drivers with torque limit setting and set to low to prevent stripping the screw.**
- **DO NOT OVER TORQUE. DO NOT EXCEED 20 in-lb TORQUE**

HP-3 Wall Mount Direct Installation Instructions

Step 6 - Closing Luminaires

A. Secure & Level Luminaires

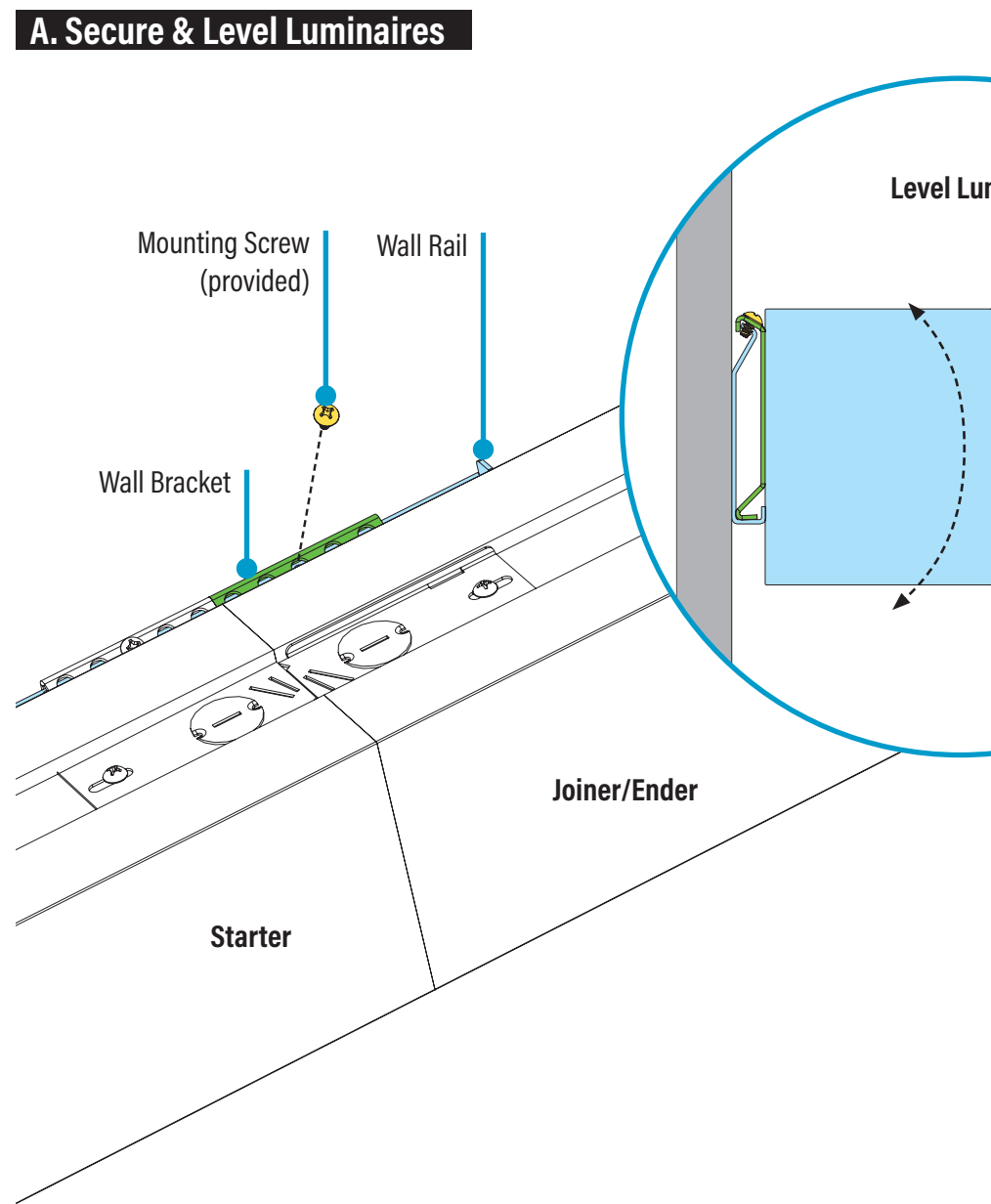

B. Final Step - Replace Backplates & Diffusers

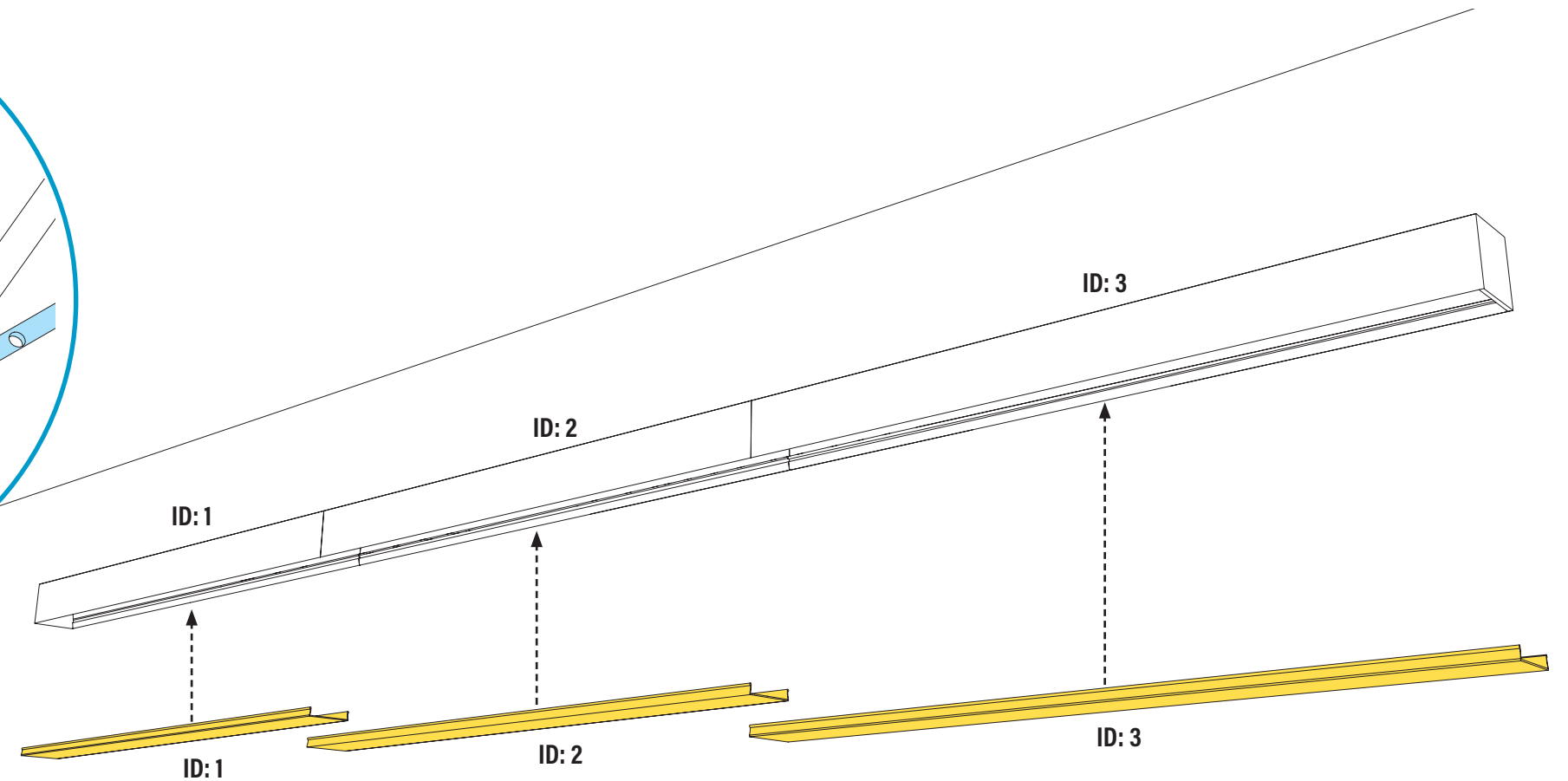

- Secure joiner/ender luminaire to wall rail with a mounting screw.
- Use mounting screws to level all luminaire sections. Tightening the screw raises and loosening the screw lowers the front edge of the luminaire.
- Tighten yoke screws¹ until joint seam of luminaires is closed.

- Remove diffusers from protective plastic bags.
- **CAUTION:** Wear gloves to keep diffuser surface clean.
- **CRITICAL:** Be sure to install correct diffuser to its corresponding luminaire ID.
- Install diffuser into luminaire body, ensuring it snaps into place.
- Turn power on to luminaires.

 **Mounting Screw**
#8-18 x 1/4" (provided)

¹ Screwdriver with 6" bit required.