

Refer to page 2 for all door styles

DESCRIPTION

HPR LED-EP is an efficient recessed luminaire delivering excellent visual comfort and outstanding performance. This luminaire features very uniform illumination of the diffusers. Advanced optical design makes HPR LED-EP a good solution for low-ceiling applications. This Product is enrolled in the International Living Future Institute (ILFI) Declare 2.0 Program and is third-party verified with options achieving **Red List Approved** and **Declared** status.

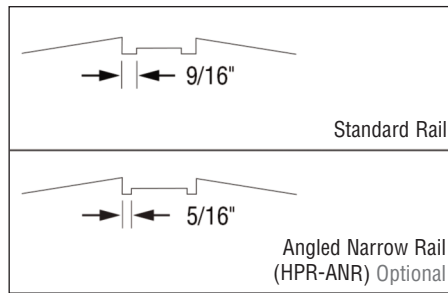
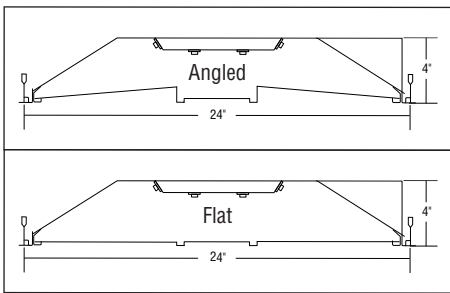

DIMENSIONS

NARROW RAIL OPTION

The available angled door style with the same center optic choices. The optional narrow rails are approximately 5/16" wide. The standard center rails are approximately 9/16" wide.

100 % SERVICEABLE FROM BELOW

The replaceable light engine and driver are easy to access from below the ceiling.

ORDERING GUIDE

Sample Number: HPR LED-EP - A - 2x2 - DCO - S - 835 - 277V - SC - C1 - OBO - RLA

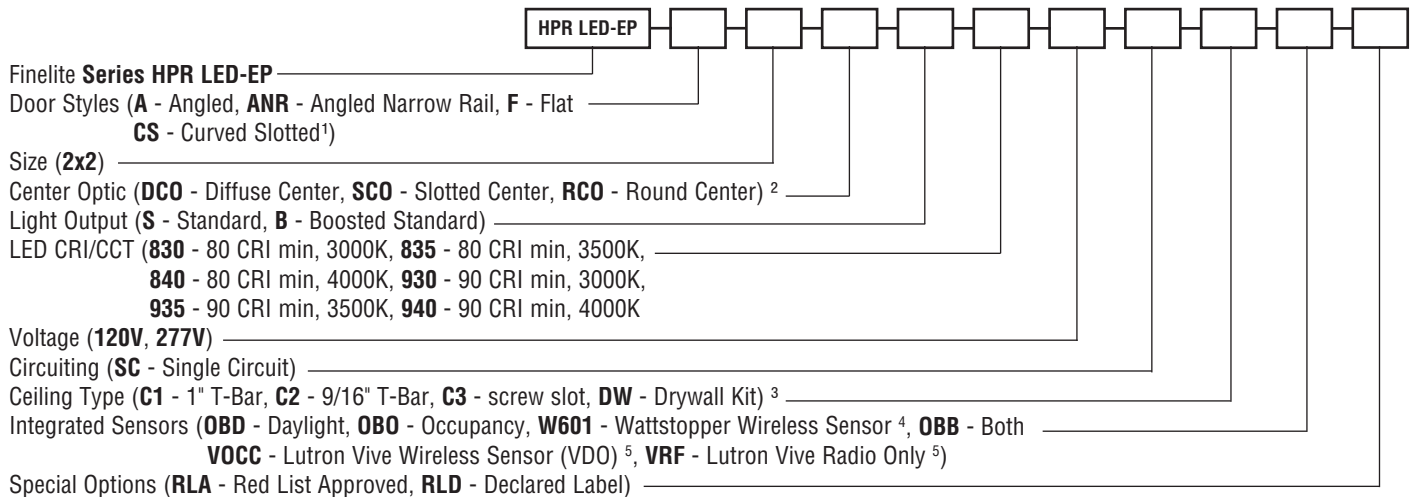

¹ Curved Slotted door not available with Center Optic options

² Only available with Angled (A), Angled Narrow Rail (ANR) and Flat (F) door options

³ Surface Mount available

⁴ LMFS-601 w/ 0-10V driver(s) and LMFI-111, up to 6 drivers may be connected.

LMFS-601 w/ DALI driver, only 1 driver can be connected.

⁵ Lutron Vive Integrated Sensors require a DALI driver

DOOR STYLES

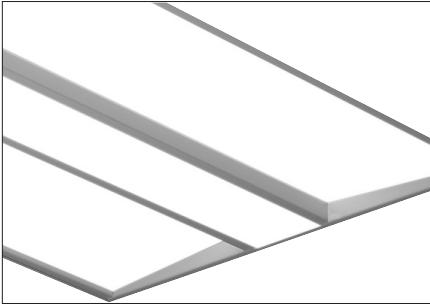

A - Angled
ANR - Angled Narrow Rail

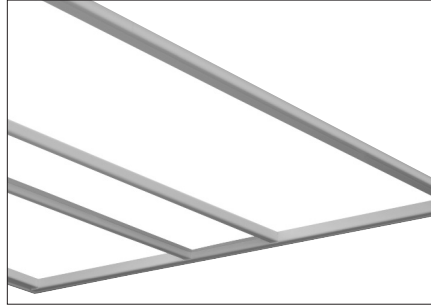

F - Flat

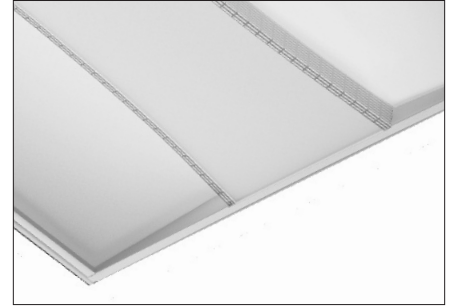

CS - Curved Slotted

CENTER OPTICS



DCO - Diffuse Center



SCO - Slotted Center

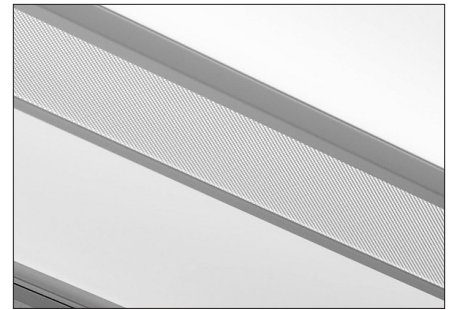

RCO - Round Center

PHOTOMETRY

HPR LED-EP-F-2x2-DCO-S
 Standard Output - Flat Rail
 Efficacy: 108 lumens per watt
 Total luminaire Output: 3099 Lumens
 22.9 Watts
 Peak Candela Value: 2149 @ 0°
 CCT: 3500K
 ITL LM79 Report: 85144

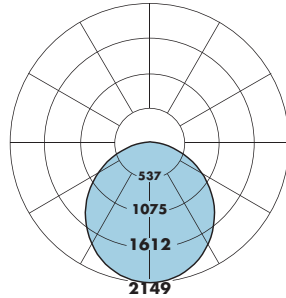

CANDLEPOWER SUMMARY						
	0.0	22.5	45	67.5	ACROSS	Flux
0	2149	2149	2149	2149	2149	
5	2139	2139	2139	2139	2139	203
10	2109	2109	2107	2106	2106	
15	2051	2052	2052	2054	2054	579
20	1975	1975	1978	1981	1983	
25	1879	1880	1883	1890	1894	868
30	1769	1769	1773	1783	1786	
35	1645	1643	1649	1662	1665	1033
40	1508	1507	1515	1527	1531	
45	1362	1361	1368	1380	1386	1057
50	1209	1207	1214	1226	1230	
55	1048	1046	1052	1060	1063	941
60	882	879	883	889	891	
65	712	708	708	713	718	703
70	539	538	534	536	540	
75	370	367	363	365	368	388
80	214	211	206	208	208	
85	84	82	78	79	80	97
90	0	0	0	0	0	

Angled (A) and Flat (F) Total Light Output, 3500K, 80 CRI (Lumens)	
S*	B**
3099	3984
Power, 3500K, 80 CRI (Watts)	
S*	B**
28.6	37.2
Efficacy, 3500K, 80 CRI (Lumens Per Watt)	
S*	B**
108	107

Lumen Adjustment Factors - 80 CRI	
3000K	0.985
3500K	1.000
4000K	1.032

Lumen Adjustment Factors - 90 CRI	
3000K	0.746
3500K	0.760
4000K	0.789

Apply a lumen adjustment factor to calculate lumens for the desired CCT and CRI.

* Family Correlation based on 3500K Very High Output (V) test - 120V.
 ** Based on ITL report: 85144

Angled Narrow Rail (ANR) Total Light Output, 3500K, 80 CRI (Lumens)	
S*	B[†]
3059	3933
Power, 3500K, 80 CRI (Watts)	
S*	B[†]
28.6	37.3
Efficacy, 3500K, 80 CRI (Lumens Per Watt)	
S*	B[†]
107	105

* Family Correlation based on 3500K Very High Output (V) test - 120V.
[†] Based on ITL report: 85150

S - Standard Output, B - Boosted Standard Output

SAMPLE LUMEN ADJUSTMENT CALCULATION

Standard Output (S) Angled (A) & Flat (F)
4000K, 90 CRI

$$\text{Lumen Adjustment Factor} = 0.789$$

$$\text{Total Light Output} = 3099 \text{ lm} \times 0.789 = 2445 \text{ lm}$$

$$\text{Efficacy} = \frac{2445 \text{ lm}}{28.5 \text{ W}} = 86 \text{ lm/W}$$

SPECIFICATIONS

CONSTRUCTION: Die-formed 20-gauge cold-rolled steel housing. All components are hard-tooled to tolerances of +/- 0.010". UV stabilized weather-strip pile gasket with polypropylene backing. Hinged door frame assembly provides easy access to light arrays and driver compartment for servicing from below. Seismic brackets are integrated into the luminaire assembly. Additional wire entrances are positioned on the ends of the housing to allow easy wiring access for the installer.

REFLECTORS: Die-formed 20-gauge cold-rolled steel reflectors are finished in 96LG high reflectance matte white powder coat paint.

AIR RETURN: Refer to 2x2 Air Return Tech Sheet for more information. Available with angled (A) and flat (F) luminaire style only.

OPTICAL SYSTEM: Components include diffuser panels and a central optic element held in place with a frame constructed from die-formed cold-rolled steel. The diffusers are UV-stabilized and impact-resistant frosted virgin acrylic, 0.120" thick. They are either angled toward the central optic or parallel to the ceiling plane. The standard center rails are approximately 9/16" wide. Optional narrows rails are approximately 5/16" wide.

DOOR STYLE: Curved Slotted (CS) includes perforated rails that slope inward and a diffuse frosted acrylic center optic.

CENTER OPTIC OPTIONS: Only available with Angled (A), Angled Narrow Rail (ANR), and Flat (F) door styles.

Diffuse Center Optic (DCO): UV-stabilized and impact-resistant frosted virgin acrylic.

Slotted Center Optic (SCO): Die-formed cold-rolled steel panel with a 1/16" x 1/2" rectangular hole pattern. Virgin acrylic overlay.

Round Center Optic (RCO): Die-formed cold-rolled steel panel with precision-punched 3/32" round hole pattern arranged in staggered formation. Virgin acrylic overlay.

LIGHT OUTPUT: Two lumen packages available, Standard (S) and Boosted Standard (B). A separate chart summarizes lumen distribution and wattage. Light engines are replaceable.

LUMEN MAINTENANCE: 90% of initial light output (L90) at 100,000+ hours; 70% of initial light output (L70) at 200,000+ hours.

DRIVER: Replaceable 120V/277V Constant Current Reduction dimming driver standard. Can be wired dimming or non-dimming. 0-10V dimming controls with a range of 10%- 100%. Dimming to 1% available; consult factory. Driver is fully accessible from below the ceiling. Power Factor: 0.9. Total Harmonic Distortion (THD): <20%.

LUTRON DRIVER OPTIONS: LUTES1 (Hi-lume 1% EcoSystem with Soft-On, Fade to Black dimming (LDE1 series)); **LUT2W** (Hi-lume 1% 2-wire, 120V forward phase dimming (LTEA series)); Contact factory for availability of discontinued Lutron drivers, L3DA-3-wire and L3DA EcoSystem.

ELECTRICAL: Optional emergency to generator/inverter wiring, internal generator transfer switch, nightlight wiring, step-dimming driver, backup battery. Chicago Plenum option. Factory-choice low-profile backup battery available. Bodine BSL722 battery pack also available. Backup batteries deliver 2199 lumens. One half of the 2x2 will be illuminated in emergency mode.

INTEGRATED SENSORS: Integrated PIR (Passive Infrared) Occupancy (OBO) or Daylight Sensors (OBD) available with Flush and Bottom Glow downlight diffusers. PIR sensors not recommended for stairwell applications. Refer to Occupancy Sensor & Daylight Sensor tech sheet and the Embedded Intelligence landing page for more information and additional sensor options.



MOUNTING: Standard flange design works with most lay-in ceiling types. Integral pry-out tabs secure the luminaire to the ceiling grid from above. Tie-in locations for tie-wire on all corners. Consult local code for appropriate tie-wire recommendations. Drywall Kit available. Surface mount and air return versions available; refer to separate tech sheets.

FINISH: Housing and door assembly painted with 96 LG high reflectance matte white powder coat paint. Optional adder: Anti-microbial paint. Contact factory.

FEED: Optional whips (with flex connectors) supplied in a maximum of 11' lengths. Lead Wires.

LABELS: Luminaire and electrical components are ETL-listed conforming to UL 916, 1598, 8750, 924 in the U.S.A. and CAN/CSA C22.2 No. 205, 250, and 141 in Canada. In accordance with NEC Code 410.73 (G), this luminaire contains an internal driver disconnect. Damp Location. IC-rated. Finelite products use electronic components that are RoHS compliant, and the mechanical components of the luminaire have been verified to not knowingly contain any restricted substances listed per RoHS Directive 2011/65/EU. Simply add - RLF (Red List Free) or - RLD (Declared) to your part number.

WEIGHT: 16 lbs maximum.

WARRANTY: 10-year performance-based warranty on all standard components. Optional accessories such as emergency battery packs are covered by their individual manufacturer warranties.