

Submitted by:		Date:
Type:	Project:	
Ordering Info:		

High Performance 4" Wet Location (HP-4 WL)



High Performance 4" Aperture Wet Location (HP-4 WL) Pendant (P), Recessed (R), Surface Mount (SM), and Wall Mount (WM) linear LED luminaire listed for wet location and IP65 and IK10 rated. HP-4 WL delivers uniform illumination with a clean linear aesthetic free of visible attachment hardware. 2', 3', 4', 5', 6', 7', and 8' section lengths. Independent and continuous rows available.

Signal White is standard finish

Note: see page 6 for all aesthetic options

CROSS SECTIONS

Pendant
Aircraft Cable

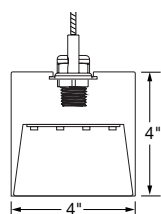

Pendant
Rigid Stem

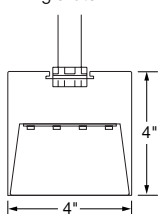

Recessed
Visible Flange

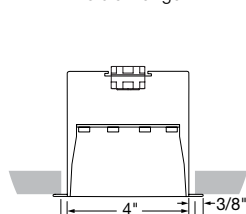

Recessed
Spackle Flange

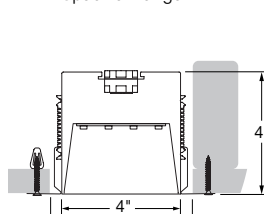

Surface Mount

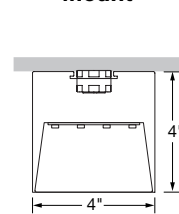

Wall Mount

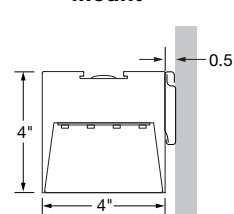

Flush Downlight Diffuser
(standard)

GET MORE WITH TAILORED LIGHTING

- Tailored Length
- Tailored Color
- Tailored Output
- Tailored Control

INTEGRATED GORE® PROTECTIVE VENT

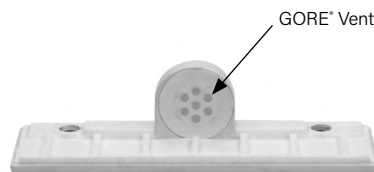

Protective vents are integrated at endcaps and joints to equalize pressure, reduce condensation and protect internal fixture components against water, salts, corrosive liquids and particulates.



Submitted by:		Date:
Type:	Project:	
Ordering Info:		

High Performance 4" Wet Location (HP-4 WL)

BODY TYPE				OUTPUT AND LED TYPE		
Platform	Series Name	Luminaire Type	Luminaire Distribution	Total Length of Run	Downlight Output	LED CRI/CCT
HP - High Performance	4 WL	P - Pendant R - Recessed SM - Surface Mount WM - Wall Mount	D - Direct	Minimum 2' section length. Increments accurate to 1', standard. 8' maximum section length.	S - Standard (354 lm/ft) B - Boosted (445 lm/ft) H - High (672 lm/ft) V - Very High (864 lm/ft) TL - Tailored: _____ lm/ft*	830 - 80 CRI, 3000K 835 - 80 CRI, 3500K 840 - 80 CRI, 4000K 930 - 90 CRI, 3000K 935 - 90 CRI, 3500K 940 - 90 CRI, 4000K

* Consult factory for tailored lumen output

MECHANICAL OPTIONS		ELECTRICAL OPTIONS	
Downlight Optics	Reflector System	Voltage	Circuiting ¹
F - Flush (standard)	96 - 96 Low Gloss White	120 - 120 Voltage 277 - 277 Voltage 347 - 347 Voltage	SC - Single Circuit* One single circuit in a run MC - Multi-Circuit* More than one switch leg or zone. Factory shop drawings required

* Battery, Night Light, and Emergency to Generator circuits are in addition to the normal luminaire circuit(s)

ELECTRICAL OPTIONS		MOUNTING OPTIONS	
Driver Selection		Mounting Method	Ceiling Hardware Type *
0-10V Driver Options FC-10% - 0-10V 10% (standard) FC-1% - 0-10V 1% OTi-10% - EldoLED OTi, 0-10V 10% ² OTi-1% - EldoLED OTi, 0-10V 1% ² ELD-10V-0% - EldoLED SOLOdrive, 0-10V 0.1% DALI Driver Options FC-DALI-1% - DALI 1% DXL-DALI-1% - EldoLED Dexal, 1% ELD-DALI-0% - EldoLED SOLOdrive, 0.1%	Lutron Driver Options LUT-ES1 - Lutron, Ecosystem 1% See Page 3 for additional driver options and details	FA50 - Fully Adjustable 50' (standard) FA100 - Fully Adjustable 100' FA150 - Fully Adjustable 150' FA200 - Fully Adjustable 200' FA250 - Fully Adjustable 250' FA300 - Fully Adjustable 300' MB - Mounting Bracket ³ RS12 - Rigid Stem 12" ⁴ RS18 - Rigid Stem 18" ⁴ RS24 - Rigid Stem 24" ⁴ RS36 - Rigid Stem 36" ⁴ SF - Spackle Flange ⁵ VF - Visual Flange ⁵	C1 - 15/16" T-Bar C2 - 9/16" T-Bar C3 - Screw Slot C4 - Hard Ceiling * Not available for Recessed

OTHER OPTIONS		
Endcap Style	Finish	Emergency Style (Optional)
FE - Flat Endcap (standard)	SW - Signal White FB - Finelite Black SA - Satin Aluminum #### - RAL Color Code ⁶	EM/GEN - Emergency to Generator NL - Night Light GTD - Generator Transfer Device ALCR - Automatic Load Control Relay ⁷

Note

Not suitable for vertical mounting
 Not suitable for natatoriums

¹ Contact factory for switching options

² Add DTO to gain "Dim to Off" functionality (FC-10% - DTO, FC-1% - DTO)

³ Wall Mount only

⁴ Direct Rigid Stem

⁵ Available for Recessed only

⁶ 20 business days lead time for color

⁷ Contact factory for restrictions

Submitted by:		Date:
Type:	Project:	
Ordering Info:		

High Performance 4" Wet Location (HP-4 WL)

SUPPLEMENTARY DRIVER PAGE

0-10V Driver Options

FC-10%	Factory Choice, 0-10V 10% Dimming (Linear)
FC-10%-DTO	Factory Choice, 0-10V 10% Dimming, Dim-to-Off (Linear)
FC-1%	Factory Choice, 0-10V 1% Dimming (Linear)
FC-1%-DTO	Factory Choice, 0-10V 1% Dimming, Dim-to-Off (Linear)
ELD-10V-0%	EldoLED SOLOdrive, 0-10V 0.1% Dimming (Linear)
ELD-10V-1%	EldoLED ECOdrive, 0-10V 1% Dimming (Linear)
OTi-10%	EldoLED OTi, 0-10V 10% Dimming (Linear)
OTi-10%-DTO	EldoLED OTi, 0-10V 10% Dimming, Dim-to-Off (Linear)
OTi-1%	EldoLED OTi, 0-10V 1% Dimming (Linear)
OTi-1%-DTO	EldoLED OTi, 0-10V 1% Dimming, Dim-to-Off (Linear)

DALI Driver Options

FC-DALI-1%	Factory Choice, DALI 1% Dimming (Logarithmic)
DXL-DALI-1%	EldoLED Dexal, DALI 1% Dimming (Logarithmic)
ELD-DALI-0%	EldoLED SOLOdrive, DALI 0.1% Dimming (Logarithmic)
ELD-DALI-1%	EldoLED ECOdrive, DALI 1% Dimming (Logarithmic)

Lutron Driver Options

LUT-ES1	Lutron, Ecosystem 1% Dimming
----------------	------------------------------

Submitted by:		Date:
Type:	Project:	
Ordering Info:		

High Performance 4" Wet Location (HP-4 WL)

SPECIFICATIONS

BODY TYPE

CONSTRUCTION: Precision-cut 6063-T6 extruded aluminum body. Internal joiner system and plug-together wiring are standard.

LENGTHS: 2', 3', 4', 5', 6', 7', and 8' section lengths. Independent and continuous rows available.

OUTPUT AND LED TYPE

LIGHT OUTPUT: Four lumen packages available, Standard (**S**), Boosted Standard (**B**), High (**H**), and Very High (**V**). For lengths 3' and greater, the uplight and downlight can be specified with different lumen packages and dual controls. For Tailored Outputs outside of range from Standard (**S**) to Very High (**V**), consult factory. Light engines are replaceable.

MECHANICAL/OPTICAL OPTIONS

DOWNLIGHT OPTION : Internal gaskets prevent moisture and debris. 8' maximum lens length. Flush frost white snap-in impact resistant acrylic lens standard, 63% transmissive, 99% diffusion.

REFLECTORS: Die-formed 20-gauge cold-rolled steel reflectors finished in 96LG High Reflectance white powder coat paint.

LUMEN MAINTENANCE: 90% of initial light output (L90) at 100,000+ hours; 70% of initial light output (L70) at 200,000+ hours.

ELECTRICAL OPTIONS

STATIC WHITE FEED: Standard with one 18-gauge/5-conductor single-circuit feed controlling uplight and downlight together (power and dimming). Specify dual feeds for independent control of uplight and downlight. 14-gauge feed used when luminaire current exceeds 5 amps.

STATIC WHITE DRIVER: Replaceable 120V/277V constant current reduction dimming driver standard. Can be wired dimming or non-dimming. 0-10V dimming controls with a range of 100%-10% standard. Dimming to 1% available. Separate dimming for uplight and downlight available. Driver is fully accessible from below the ceiling.

- **Power Factor:** ≥ 0.9
- **Total Harmonic Distortion (THD):** <20%
- **Expected driver lifetime:** 100,000 hours

LUTRON DRIVER OPTIONS:

LUT-ES - Hi-lume 1% EcoSystem with Soft-On, Fade-to-Black dimming (LDE1 series).

MOUNTING OPTIONS

HANGING HARDWARE:

All HP-4 Wet Location luminaires **CANNOT** be installed upside down for indirect /uplight illumination. All HP-4 Wet Location luminaires are direct / downlight illumination only.

- **Pendant:** 50" Fully Adjustable (**FA**) 316 stainless steel aircraft cable with safety stop hardware standard. Aircraft cable suspension is not recommended for applications where wind or weather could contribute to a recurrent swaying motion. Follow all local/national codes to ensure proper bracing is used to meet

the safety requirements set by the authority having jurisdiction. Bracing/Anti-Sway hardware, if needed for the application, is to be provided by others. 1/2" IPS rigid stem, available in 12", 18", 24" or 36" overall lengths.

- **Recessed:** Visible flange mounting offers a 3/8" visible flange integral to the extruded luminaire body. Spackle flange option also available. Not suitable for vertical mounting.
- **Surface Mount:** Drywall or concrete surfaces: 1/4 - 20 lag bolt (provided by others) or 1/4 - 20 stud and nut (provided by others). Gasketed washer provided to maintain water seal of fixture at mounting hole locations. Not suitable for vertical mounting. **Luminaire body must be fully mounted and flush to solid structure.**
- **Wall Mount:** Fixture hangs securely from mounting brackets fastened directly to the wall for easy installation. Fixture stands 1/2" off the wall. Consult factory for tailored lighting options.

OTHER OPTIONS

ENDCAPS: Flat diecast aluminum endcaps (**FE**) add 1/4" to each end of luminaire. Each joints add 1/4" to overall length.

EMERGENCY STYLE: Optional emergency to generator/inverter wiring, internal generator transfer switch, nightlight wiring, step-dimming driver. No Battery Backup options on wet location luminaire.

FINISHES: Finelite Signal White (**SW**) powder coat, Finelite Black (RAL 9005) with semi gloss fine texture (**FB**) and Satin Aluminum (**SA**) are standard. Optional Adders: 179 RAL colors¹. Primer undercoat standard on HP-4 WL.

WET LOCATION: UL wet location listed and IP65 rated.

SPECIAL FEATURES: Integrated GORE® protective vent allows moisture to escape the fixture without letting water in and protects internal components from salts, corrosive liquids, and particulates.

TEMPERATURE RATING: Rated for -20°C to 40°C

LABELS: Luminaire and electrical components are ETL-listed conforming to UL 1598 in the U.S.A. and CAN/CSA C22.2 No. 250.0 in Canada. In accordance with NEC Code 410.130 (G), this luminaire contains an internal driver disconnect. UL wet location listed and IP65. IC-rated. Finelite products use electronic components that are RoHS compliant, and the mechanical components of the luminaire have been verified to not knowingly contain any restricted substances listed per RoHS Directive 2015/863.

WEIGHT²: D - 3.2 lb/ft; R - 3.6 lb/ft; SM - 3.2 lb/ft; WM - 3.23 lb/ft

WARRANTY: 5-year performance-based warranty on all standard components.

¹ 20 business days lead time for color

² Excludes Battery Backup and Generator Transfer Device weight

Submitted by:		Date:
Type:	Project:	
Ordering Info:		

High Performance 4" Wet Location (HP-4 WL)

INDEPENDENT OR CONTINUOUS ROWS

2', 3', 4', 5', 6', 7', and 8' section lengths. Independent and continuous rows available.

For **independent luminaires** add **1/4"** for each endcap for overall length.

Example: 4' = 4'-1/2"

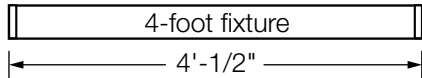

Endcaps and Joins = **1/4"**

Example: 8' = 8'-1/2"

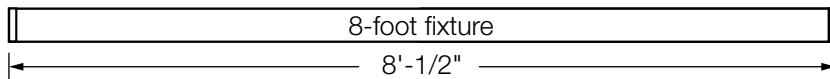

For **continuous rows** add **1/4"** for each endcap and **1/4"** for each joint for overall length.

Example: 24' = 24'-1"

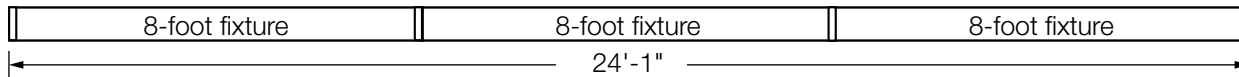

Above drawings not to scale.

SPACKLE FLANGE DEPTH OPTIONS

Spackle Flange can be specified to various depths to accommodate different building materials and thicknesses.

The minimum depth is 1/16" and can be specified in 1/8" increments up to a maximum depth of 13/16".

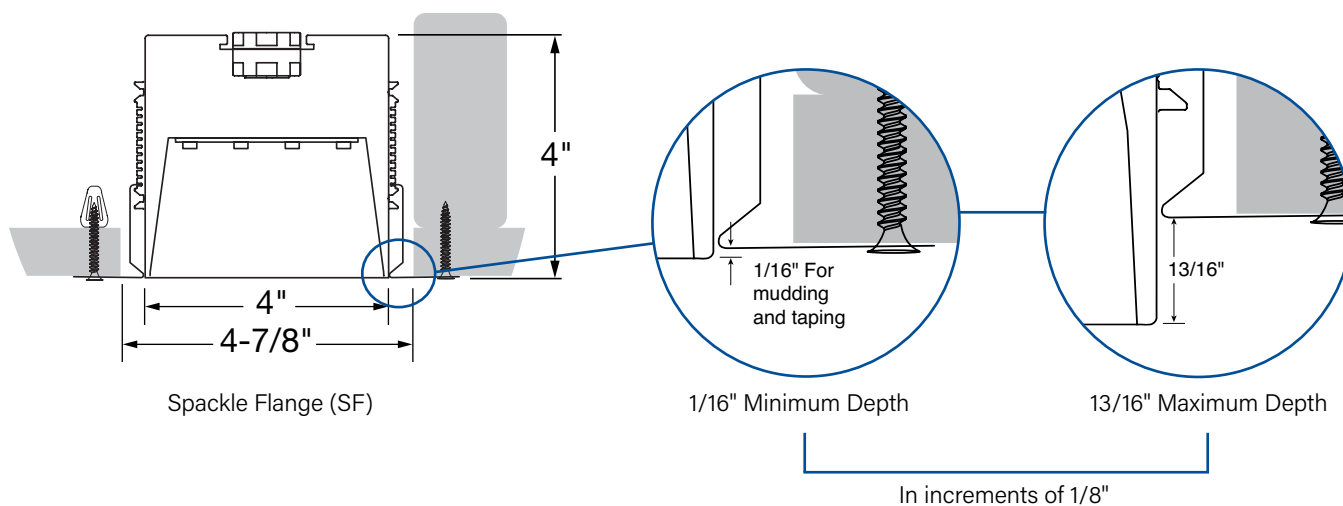

Submitted by:		Date:
Type:	Project:	
Ordering Info:		

High Performance 4" Wet Location (HP-4 WL)

HARD CEILING MOUNTING OPTIONS

Threaded Rod Option

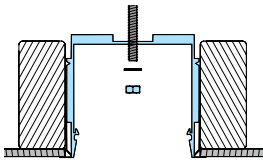

Screw Mount Option

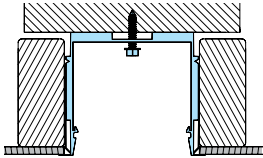

Mounting Location for Securing to Structure Excluding Endcap

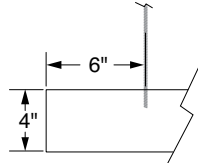

Threaded rod and screw mounting options. Mounting locations are located on each end of the luminaire. Mounting location is 6" away from each end of luminaire.

HOUSINGS

Version 1

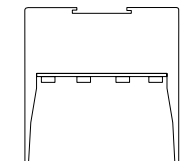

Visible Flange (VF)

Version 2

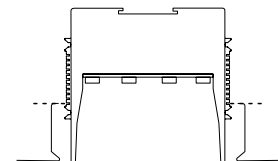

Spackle Flange (SF)

HARD CEILING LENGTH DETAIL - 4' Example

Spackle Flange

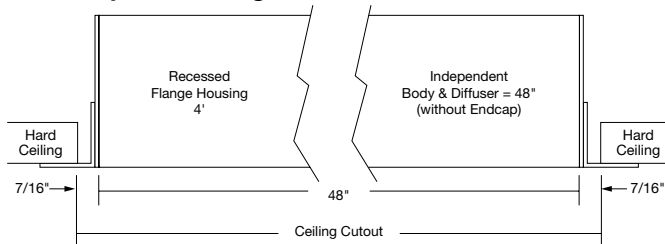

Visible Flange

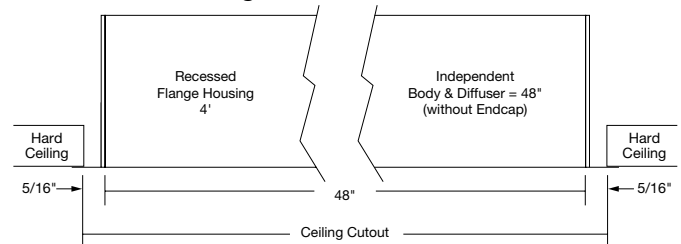

Submitted by:		Date:
Type:	Project:	
Ordering Info:		

High Performance 4" Wet Location (HP-4 WL)

Direct Photometry - 4' Luminaire 3500K

HP4-WL-D-4'-V-835

Downlight: Flush Diffuser

Efficacy: 94 lm/W

Total luminaire output: 3456 lumens (864 lm/ft)
36.9 watts (9.2 W/ft)

Peak Candela Value: 1256 @ 0°

CRI: 80 / CCT: 3500K

ITL LM79 Report 90390

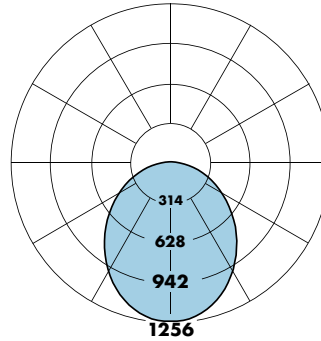

CANDELA DISTRIBUTION						
	0.0	22.5	45.0	67.5	90.0	FLUX
0	1256	1256	1256	1256	1256	
5	1250	1250	1250	1249	1249	119
15	1203	1195	1199	1199	1198	338
25	1107	1095	1103	1098	1094	507
35	976	964	968	960	957	603
45	814	804	804	797	792	618
55	629	622	620	612	607	553
65	430	426	422	417	414	417
75	226	225	223	222	224	237
85	52	54	55	56	57	64
90	0	0	0	0	0	

Total Light Output, 3500K, 80 CRI (Lumens) - 4' Luminaire

S ¹	B ¹	H ¹	V ²
1415	1779	2688	3456

Light Output, 3500K, 80 CRI (Lumens Per Foot)

S ¹	B ¹	H ¹	V ²
354	445	672	864

Power, 3500K (Watts Per Foot)

S ¹	B ¹	H ¹	V ²
3.6	4.6	7.1	9.2

Efficacy, 3500K, 80 CRI (Lumens Per Watt)

S ¹	B ¹	H ¹	V ²
98	97	95	94

Sample Lumen Adjustment Calculation

Lumen Adjustment Factors 80 CRI

3000K	0.985
3500K	1.000
4000K	1.032

Lumen Adjustment Factors 90 CRI

3000K	0.746
3500K	0.760
4000K	0.789

High Output (H), 4000K, 90 CRI

Lumen Adjustment Factor: 0.789

Total Light Output: 2688 lm x 0.789 = 2121 lm

Total Light Output per Foot: 672 lm/ft x 0.789 = 530 lm/ft.

watts/foot: 71 W/ft.

$$\text{Efficacy} = \frac{530 \frac{\text{lm}}{\text{ft.}}}{71 \frac{\text{W}}{\text{ft.}}} = 75 \text{ lm/W}$$

Wattage is Real Power. If you would like additional details to calculate Apparent Power, please contact your local Finelite representative.

S - Standard Output, B - Boosted Standard Output, H - High Output, V - Very High Output

¹ Family Correlation based on 4' luminaire 3500K Very High Output (V) test - 120V.

² Based on ITL report: 90390