

FINELITE Tunable White High Performance Recessed (HPR LED-EP) 2x2 Air Return Boosted Standard Output (B)



Date

Project

Type

Comments

Refer to page 3 for all door styles

DESCRIPTION

HPR LED-EP Air Return is a highly effective luminaire delivering excellent visual comfort and outstanding performance. This enhanced performance luminaire features a very uniform diffuser aesthetic. Advanced optical designs make the HPR LED-EP Air Return a powerful solution for low-ceiling applications and eliminate the shadows common to other LED products. HPR LED Air Return effectively removes air from the space with little change to the luminaire aesthetic. This Product is enrolled in the International Living Future Institute (ILFI) Declare 2.0 Program and is third-party verified with options achieving Red List Approved and Declared status.

ORDERING GUIDE

Sample Number: HPR LED-EP - A - 2x2 - DCO - B - 8TW - 277V - SC - C1 - AR - RLA

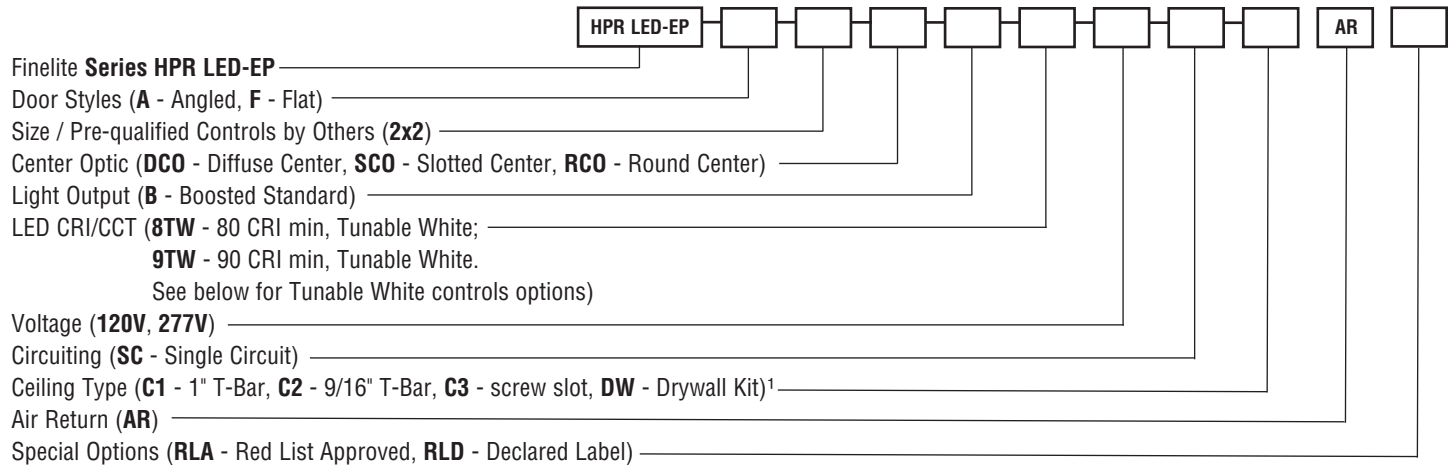

¹ Surface Mount available

TUNABLE WHITE CONTROLS OPTIONS: SELECT ONE



FineTune controller with FineTune DMX Driver

OR

- Controls by others with pre-qualified DMX driver
- Controls by others with pre-qualified DALI driver
- Controls by others with pre-qualified PoE setup
- Controls by Lutron with pre-qualified Lutron driver

A brand of legrand

Finelite, Inc. • 30500 Whipple Road • Union City, CA 94587-1530 • (510) 441-1100 • Fax: (510) 441-1510 • www.finelite.com

FINELITE Tunable White High Performance Recessed (HPR LED-EP) 2x2 Air Return Boosted Standard Output (B)

LUMINAIRE FEATURES

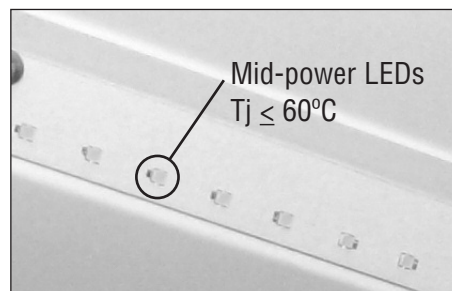
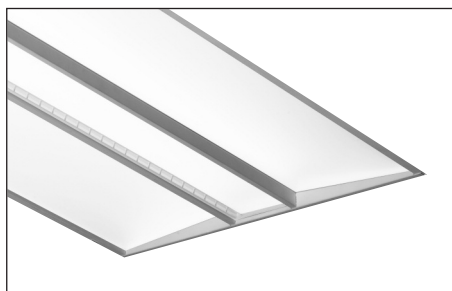
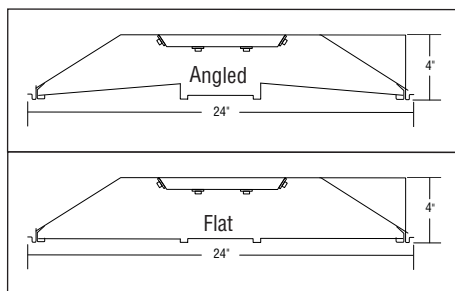

DIMENSIONS

TWICE THE UNIFORMITY

HPR EP uses new LED arrays and materials to deliver a diffuser that is twice as uniform when compared to standard luminaires.

THERMAL MANAGEMENT

Mid-power LEDs allow heat to be fully dissipated without the need for additional heat sinks.

TUNABLE WHITE FEATURES

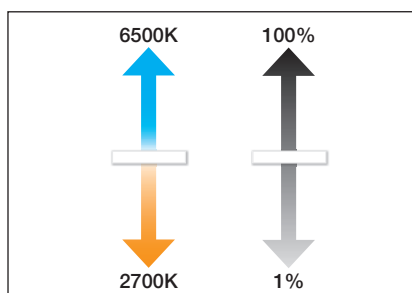
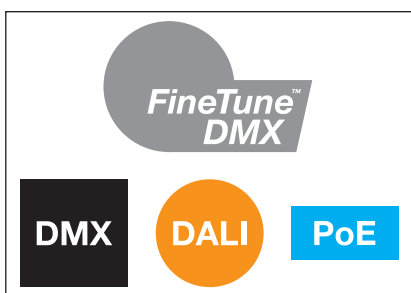

MULTIPLE CONTROL ARCHITECTURES

Finelite's FineTune™ DMX, qualified DMX, DALI (open and proprietary), or PoE (Power over Ethernet).

TUNABLE WHITE

Any CCT between 2700K and 6500K with excellent CRI and R9 values; dimming from 100% to 1%.

FINETUNE SYSTEM

Award-winning control system, which includes intuitive wall mounted controller, power control center, driver, and mobile app to easily tailor lighting to match user preference.

DMX CONNECTION

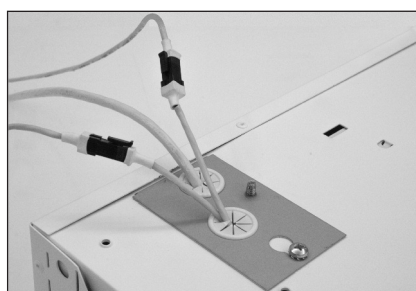

FINELITE

Tunable White High Performance Recessed (HPR LED-EP) 2x2 Air Return Boosted Standard Output (B)

DOOR STYLES

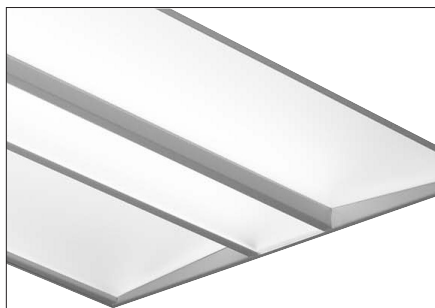

A - Angled

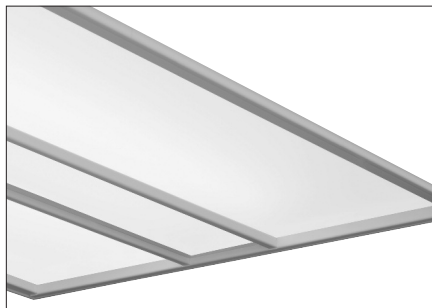

F - Flat

CENTER OPTICS



DCO - Diffuse Center



SCO - Slotted Center



RCO - Round Center

FINELITE

Tunable White High Performance Recessed (HPR LED-EP) 2x2 Air Return Boosted Standard Output (B)

PHOTOMETRY

HPR LED-EP-F-2x2-DC0-V
 Boosted Standard Output - Flat Rail
 Total luminaire Output: 5871 Lumens
 Peak Candela Value: 2149 @ 0°
 CCT: 3500K
 ITL LM79 Report: 85144

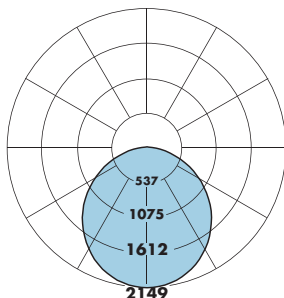

CANDELA DISTRIBUTION						
	0.0	22.5	45	67.5	ACROSS	Flux
0	2149	2149	2149	2149	2149	
5	2139	2139	2139	2139	2139	203
10	2109	2109	2107	2106	2106	
15	2051	2052	2052	2054	2054	579
20	1975	1975	1978	1981	1983	
25	1879	1880	1883	1890	1894	868
30	1769	1769	1773	1783	1786	
35	1645	1643	1649	1662	1665	1033
40	1508	1507	1515	1527	1531	
45	1362	1361	1368	1380	1386	1057
50	1209	1207	1214	1226	1230	
55	1048	1046	1052	1060	1063	941
60	882	879	883	889	891	
65	712	708	708	713	718	703
70	539	538	534	536	540	
75	370	367	363	365	368	388
80	214	211	206	208	208	
85	84	82	78	79	80	97
90	0	0	0	0	0	

Angled (A) and Flat (F) Total Light Output, 3500K, 80 CRI (Lumens)	
B*	3984
Power, 3500K, 80 CRI (Watts)	
B*	40.9
Efficacy, 3500K, 80 CRI (Lumens Per Watt)	
B*	97

* Based on ITL report: 85144 3500K, 80 CRI Very High Output (V) test - 120V

Angled Narrow Rail (ANR) Total Light Output, 3500K, 80 CRI (Lumens)	
B**	3933
Power, 3500K, 80 CRI (Watts)	
B**	41.0
Efficacy, 3500K, 80 CRI (Lumens Per Watt)	
B**	96

B - Boosted Standard Output

** Based on ITL report: 85150 3500K, 80 CRI Very High Output (V) test - 120V

Lumen Adjustment Factors - 80 CRI	
2700K	0.968
3000K	0.985
3500K	1.000
4000K	1.032
6500K	1.032

Lumen Adjustment Factors - 90 CRI	
2700K	0.731
3000K	0.746
3500K	0.760
4000K	0.789
6500K	0.789

Apply a lumen adjustment factor to calculate lumens for the desired CCT and CRI.

SAMPLE LUMEN ADJUSTMENT CALCULATION

$$\frac{\text{Boosted Standard Output (B)}}{\text{Angled (A) \& Flat (F) 4000K, 90 CRI}}$$

$$\text{Lumen Adjustment Factor} = 0.789$$

$$\text{Total Light Output} = 3984 \text{ lm} \times 0.789 = 3143 \text{ lm}$$

$$\text{Efficacy} = \frac{3143 \text{ lm}}{40.9 \text{ W}} = 77 \text{ lm/W}$$

FINELITE (HPR LED-EP) 2x2 Air Return Boosted Standard Output (B)

CEILING SYSTEM INFORMATION

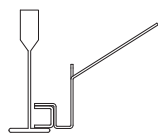

9/16" T-Bar

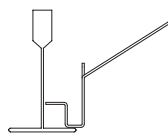

15/16" T-Bar

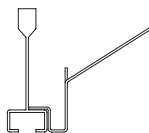

Screw Slot T-Bar

AIR HANDLING INFORMATION

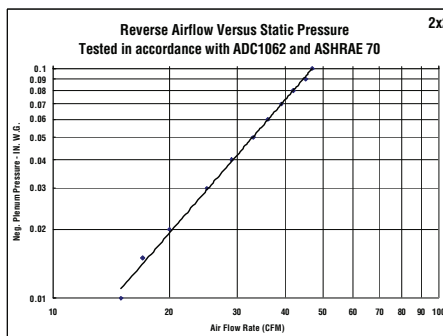

SPECIFICATIONS

CONSTRUCTION: Die-formed 20-gauge cold-rolled steel housing. All components are hard-tooled to tolerances of +/- 0.010". UV stabilized weather-strip pile gasket with polypropylene backing. Hinged door frame assembly provides easy access to light arrays and driver compartment for servicing from below. Seismic brackets are integrated into the luminaire assembly. Additional wire entrances are positioned on the ends of the housing to allow easy wiring access for the installer.

REFLECTORS: Die-formed 20-gauge cold-rolled steel reflectors are finished in 96LG high reflectance matte white powder coat paint.

AIR RETURN: Luminaire tested in accordance with ADC1062 and ASHRAE 70. Air Return slots positioned on the center optic. Diffuse Center (DCO) is placed above the air return slots. Other center optics are positioned below the air return slots.

OPTICAL SYSTEM: Components include diffuser panels and a central optic element held in place with a frame constructed from die-formed cold-rolled steel. The diffusers are UV-stabilized and impact-resistant frosted virgin acrylic, 1/8" thick. They are either angled toward the central optic or parallel to the ceiling plane.

CENTER OPTIC OPTIONS: Only available with Angled (A), and Flat (F) door styles.

Diffuse Center Optic (DCO): UV-stabilized and impact-resistant frosted virgin acrylic.

Slotted Center Optic (SCO): Die-formed cold-rolled steel panel with a 1/16" x 1/2" rectangular hole pattern. Virgin acrylic overlay.

Round Center Optic (RCO): Die-formed cold-rolled steel panel with precision-punched 3/32" round hole pattern arranged in staggered formation. Virgin acrylic overlay.

LIGHT OUTPUT: Available in Boosted Standard (B). A separate chart summarizes lumen distribution and wattage. Light engines are replaceable.

LUMEN MAINTENANCE: 90% of initial light output (L90) at 100,000+ hours; 70% of initial light output (L70) at 200,000+ hours.

TUNABLE WHITE DRIVER: Replaceable LED driver accessible from below the ceiling. 120/277V. Power factor ≥0.9. Total Harmonic Distortion (THD): <20%. Dimming Range: 100% - 1%. Expected driver lifetime: 100,000 hours.

LUTRON DRIVER OPTIONS: LutDTW (1% T-Series 2-Channel Digital Tunable White (PSQ Series)).

ELECTRICAL:

Emergency Option DMX: Battery backup only.

Emergency Option DALI: Battery backup, emergency-to-generator/ inverter wiring.

Emergency Option Lutron: Battery backup, emergency-to-generator/ inverter wiring.

Emergency Option PoE: Contact factory.

Battery Backup: Factory-choice low-profile backup battery available. Backup batteries deliver 2199 lumens. One quarter of the 1x4 will be illuminated in emergency mode. Backup battery will operate at 6500K in emergency.

MOUNTING: Standard flange design works with most lay-in ceiling types. Integral pry-out tabs secure the luminaire to the ceiling grid from above. Tie-in locations for tie-wire on all corners. Consult local code for appropriate tie-wire recommendations. Drywall and Surface Mount versions available; refer to separate tech sheets.

DMX INTERCONNECTION CABLES: Luminaires are prewired with plug-and-play interconnection cables to support easy plug-together joining of luminaire runs. If a non-FineTune DMX system has been specified, a DMX to RJ45 converter is provided.

FINISHES: Housing and door assembly painted with 96LG high reflectance matte white powder coat paint. Optional adder: Anti-microbial paint. Contact factory.

FEED: Standard with one 18-gauge single-circuit feed. 14-gauge feed available on request. DMX and power feed at same location (standard). Optional whips (with flex connectors) supplied in a maximum of 11' lengths. Lead Wires. DMX feeds cannot be cut or spliced. DMX feeds should be ordered based on fixed lengths.

LABELS: Luminaire and electrical components are ETL-listed conforming to UL 916, 1598, 8750, 924 in the U.S.A. and CAN/CSA C22.2 No. 205, 250, and 141 in Canada. In accordance with NEC Code 410.73 (G), this luminaire contains an internal driver disconnect. Damp Location. Finelite products use electronic components that are RoHS compliant, and the mechanical components of the luminaire have been verified to not knowingly contain any restricted substances listed per RoHS Directive 2011/65/EU. Finelite makes the specification process easy when putting healthier products on your projects. Simply add – RLA (Red List Approved) or – RLD (Declared Label) to your part number.

WEIGHT: 16 lbs maximum.

WARRANTY: 10-year performance-based warranty on all standard components. Qualified drivers by others and optional accessories such as emergency battery packs are covered by their individual manufacturer warranties.

TUNABLE WHITE PRE-QUALIFIED DRIVERS BY OTHERS

DMX	DALI	POE set up	LUTRON
EldoLED	EldoLED, Crestron	Contact Factory	LUTRON

NOTE: For a complete list of system option/limitations [please click here](#).

A brand of **legrand**

Finelite, Inc. • 30500 Whipple Road • Union City, CA 94587-1530 • (510) 441-1100 • Fax: (510) 441-1510 • www.finelite.com

Due to continuing product improvements, Finelite reserves the right to change specifications without notice. Please visit www.finelite.com for most current data.