

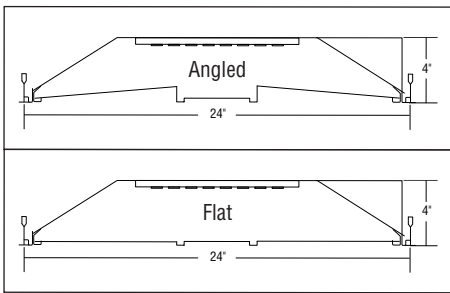

Refer to page 2 for all door styles

DESCRIPTION

HPR LED is a highly efficient recessed luminaire delivering excellent visual comfort and outstanding performance. Advanced optical design makes HPR LED a powerful solution for low-ceiling applications and eliminates the shadows common to other LED recessed products. This Product is enrolled in the International Living Future Institute (ILFI) Declare 2.0 Program and is third-party verified with options achieving **Red List Approved** and **Declared** status.



DIMENSIONS

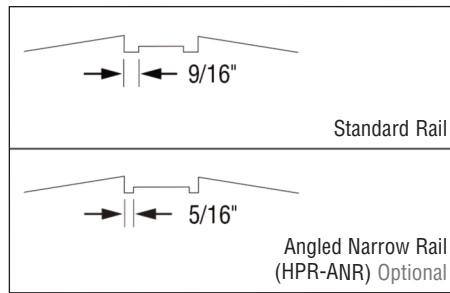

ANGLED NARROW RAIL OPTION

Available in angled door style with the same center optic choices. The optional narrow rails are approximately 5/16" wide. The standard center rails are approximately 9/16" wide.

Date

Project

Type

Comments



100% SERVICEABLE FROM BELOW

The replaceable light engine and driver are easy to access from below the ceiling.

ORDERING GUIDE

Sample Number: HPR LED - A - 2x2 - DCO - S - 835 - 277V - SC - C1 - OBO - RLA

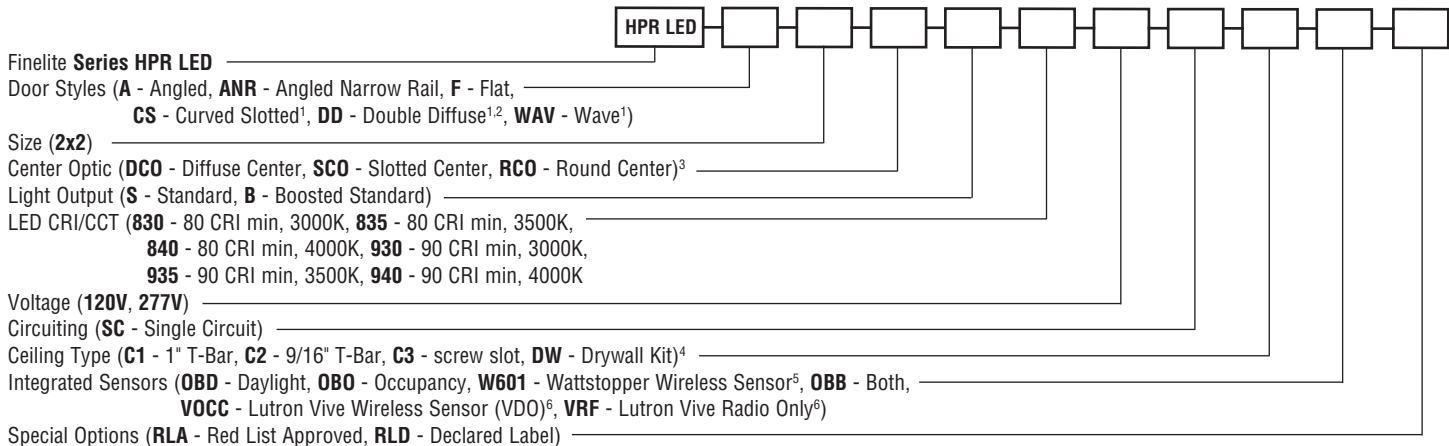

¹ Curved Slotted, Double Diffuse and Wave door not available with Center Optic options
² Double Diffuse not available with sensors
³ Only available with Angled (A), Angled Narrow Rail (ANR) and Flat (F) door options
⁴ Surface Mount available
⁵ LMFS-601 w/ 0-10V driver(s) and LMFI-111, up to 6 drivers may be connected. LMFS-601 w/ DALI driver, only 1 driver can be connected.
⁶ Lutron Vive Integrated Sensors require a DALI driver

DOOR STYLES

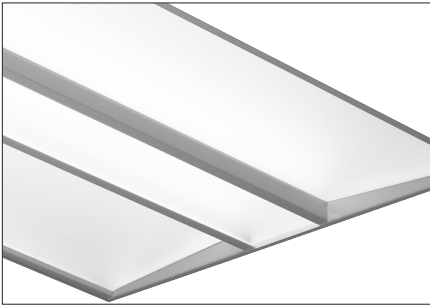

A - Angled
ANR - Angled Narrow Rail

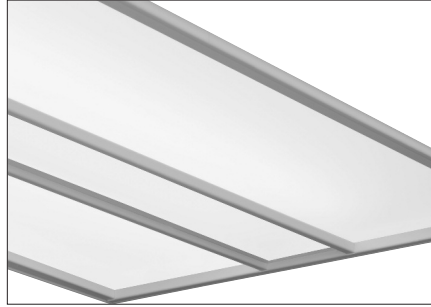

F - Flat

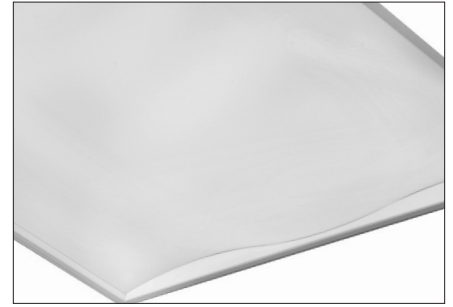

WAV - Wave

DOOR STYLES

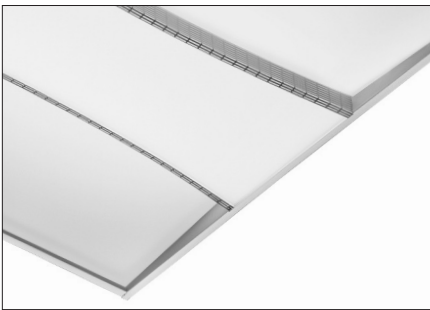

CS - Curved Slotted

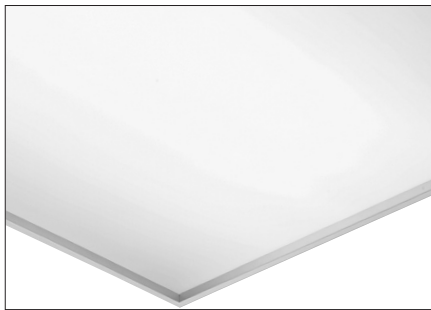

DD - Double Diffuse

CENTER OPTICS



DCO - Diffuse Center



SCO - Slotted Center



RCO - Round Center

DCO, SCO, and RCO are only available on Angled (A), Angled Narrow Rail (ANR), and Flat (F) doors.

PHOTOMETRY

HPR LED-A-2x2-DCO-V
Standard Output - Angled Rail
Efficacy: 119 lumens per watt
Total luminaire output: 3397 Lumens
28.5 Watts
Peak Cadela Value: 2574 @ 0°
CCT: 3500K
ITL LM79 Report 85142

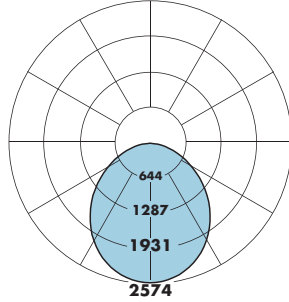

CANDLEPOWER SUMMARY						
	0.0	22.5	45	67.5	ACROSS	Flux
0	2574	2574	2574	2574	2574	2574
5	2561	2561	2560	2559	2560	243
10	2519	2517	2515	2514	2514	
15	2440	2439	2441	2442	2444	688
20	2332	2333	2337	2344	2347	
25	2199	2199	2207	2217	2224	1016
30	2038	2040	2052	2070	2076	
35	1861	1863	1877	1900	1907	1175
40	1668	1671	1690	1713	1721	
45	1475	1473	1494	1517	1529	1154
50	1272	1272	1293	1314	1323	
55	1075	1074	1093	1109	1116	978
60	880	880	894	909	910	
65	693	696	702	712	718	699
70	519	519	524	532	537	
75	356	354	357	362	367	382
80	211	209	210	213	216	
85	87	87	85	83	85	101
90	0	0	0	0	0	

Angled (A) and Flat (F) Total Light Output, 3500K, 80 CRI (Lumens)	
S*	B**
3397	4367
Power, 3500K, 80 CRI (Watts)	
S*	B**
28.5	37.1
Efficacy, 3500K, 80 CRI (Lumens Per Watt)	
S*	B**
119	118

Lumen Adjustment Factors - 80 CRI	
3000K	0.985
3500K	1.000
4000K	1.032

Lumen Adjustment Factors - 90 CRI	
3000K	0.746
3500K	0.760
4000K	0.789

Apply a lumen adjustment factor to calculate lumens for the desired CCT and CRI.

* Family Correlation based on 3500K Very High Output (V) test - 120V.
** Based on source ITL report: 85142

Angled Narrow Rail (ANR) Total Light Output, 3500K, 80 CRI (Lumens)	
S*	B^y
3276	4212
Power, 3500K, 80 CRI (Watts)	
S*	B^y
28.6	37.2
Efficacy, 3500K, 80 CRI (Lumens Per Watt)	
S*	B^y
115	113

* Family Correlation based on 3500K Very High Output (V) test - 120V.
^y Based on source ITL report: 85148

S - Standard Output, B - Boosted Standard Output

SAMPLE LUMEN ADJUSTMENT CALCULATION

Standard Output (S) Angled (A) & Flat (F)
4000K, 90 CRI

Lumen Adjustment Factor = 0.789

Total Light Output =
3397 lm x 0.789 = 2680 lm

$$\text{Efficacy} = \frac{2680 \text{ lm}}{28.4 \text{ W}} = 94 \text{ lm/W}$$

Wave (WAV) Total Light Output, 3500K, 80 CRI (Lumens)	
S*	B†
3470	4461
Power, 3500K, 80 CRI (Watts)	
S*	B†
28.5	37.2
Efficacy, 3500K, 80 CRI (Lumens Per Watt)	
S*	B†
128	120

* Family Correlation based on 3500K Very High Output (V) test - 120V.
† Based on source ITL report: 85836

Curve Slotted (CS) Total Light Output, 3500K, 80 CRI (Lumens)	
S*	B†
3236	4161
Power, 3500K, 80 CRI (Watts)	
S*	B†
28.5	37.2
Efficacy, 3500K, 80 CRI (Lumens Per Watt)	
S*	B†
113.5	112.0

* Family Correlation based on 3500K Very High Output (V) test - 120V.
† Based on source ITL report: 86019

Double Diffuse (DD) Total Light Output, 3500K, 80 CRI (Lumens)	
S*	B‡
2720	3497
Power, 3500K, 80 CRI (Watts)	
S*	B‡
28.5	37.2
Efficacy, 3500K, 80 CRI (Lumens Per Watt)	
S*	B‡
95	94

* Family Correlation based on 3500K Very High Output (V) test - 120V.
‡ Based on source ITL report: 85154

S - Standard Output, B - Boosted Standard Output

Lumen Adjustment Factors - 80 CRI	
3000K	0.985
3500K	1.000
4000K	1.032

Lumen Adjustment Factors - 90 CRI	
3000K	0.746
3500K	0.760
4000K	0.789

Apply a lumen adjustment factor to calculate lumens for the desired CCT and CRI

SPECIFICATIONS

CONSTRUCTION: Die-formed 20-gauge cold-rolled steel housing. All components are hard-tooled to tolerances of +/- 0.010". UV stabilized weather-strip pile gasket with polypropylene backing. Hinged door frame assembly provides easy access to light arrays and driver compartment for servicing from below. Seismic brackets are integrated into the luminaire assembly. Additional wire entrances are positioned on the ends of the housing to allow easy wiring access for the installer.

REFLECTORS: Die-formed 20-gauge cold-rolled steel reflectors are finished in 96LG high reflectance matte white powder coat paint.

AIR RETURN: Refer to 2x2 Air Return Tech Sheet for more information.

OPTICAL SYSTEM: Components include diffuser panels and a central optic element held in place with a frame constructed from die-formed cold-rolled steel. The diffusers are UV-stabilized and impact-resistant frosted virgin acrylic, 0.120" thick. They are either angled toward the central optic or parallel to the ceiling plane. The center optical element is held in place by sleek steel rails. The standard center rails are approximately 9/16" wide. Optional narrow rails are approximately 5/16" wide. Optional wave door includes frosted acrylic panel that undulates from side to side.

DOUBLE DIFFUSE: Visible diffuser: UV-stabilized and impact-resistant frosted virgin acrylic, 0.120" thick. Inner diffuser: 0.120" thick with 60% round perforations white/white.

DOOR STYLE: Curved Slotted (CS) includes perforated rails that slope inward and a diffuse frosted acrylic center optic.

CENTER OPTIC OPTIONS: Only available with Angled (A), Angled Narrow Rail (ANR), and Flat (F) door styles.

Diffuse Center Optic (DCO): UV-stabilized and impact-resistant frosted virgin acrylic.

Slotted Center Optic (SCO): Die-formed cold-rolled steel panel with a 1/16" x 1/2" rectangular hole pattern. Virgin acrylic overlay.

Round Center Optic (RCO): Die-formed cold-rolled steel panel with precision-punched 3/32" round hole pattern arranged in staggered formation. Virgin acrylic overlay.

LIGHT OUTPUT: Two lumen packages available, Standard (S), Boosted Standard (B). A separate chart summarizes lumen distribution and wattage. Light engines are replaceable.

LUMEN MAINTENANCE: 90% of initial light output (L90) at 100,000+ hours; 70% of initial light output (L70) at 200,000+ hours.

DRIVER: Replaceable 120V/277V Constant Current Reduction dimming driver standard. Can be wired dimming or non-dimming. 0-10V dimming controls with a range of 10%- 100%. Dimming to 1% available, consult factory. Driver is fully accessible from below the ceiling. Power Factor: 0.9. Total Harmonic Distortion (THD): <20%. Expected driver lifetime: 100,000 hours.

LUTRON DRIVER OPTIONS: LUTES1 (Hi-lume 1% EcoSystem with Soft-On, Fade to Black dimming (LDE1 series)); LUT2W (Hi-lume 1% 2-wire, 120V forward phase dimming (LTEA series)); Contact factory for availability of discontinued Lutron drivers, L3DA-3-wire and L3DA EcoSystem.

ELECTRICAL: Optional emergency to generator/inverter wiring, internal generator transfer switch, nightlight wiring, step-dimming driver, backup battery. Chicago Plenum option. Factory-choice low-profile backup battery available. Bodine BSL722 battery pack also available. Backup batteries deliver 2199 lumens. One quarter of the 2x2 will be illuminated in emergency mode.

INTEGRATED SENSORS: Integrated PIR (Passive Infrared) Occupancy (OBO) or Daylight Sensors (OBD) available with Flush and Bottom Glow downlight diffusers. PIR sensors not recommended for stairwell applications. Refer to Occupancy Sensor & Daylight Sensor tech sheet and the Embedded Intelligence landing page for more information and additional sensor options.

MOUNTING: Standard flange design works with most lay-in ceiling types. Integral pry-out tabs secure the luminaire to the ceiling grid from above. Tie-in locations for tie-wire on all corners. Consult local code for appropriate tie-wire recommendations. Drywall Kit available. Surface mount and air return versions available; refer to separate tech sheets.

FINISH: Housing and door assembly painted with 96 LG high reflectance matte white powder coat paint. Optional adder: Anti-microbial paint. Contact factory.

FEED: Optional whips (with flex connectors) supplied in a maximum of 11' lengths. Lead Wires.

LABELS: Luminaire and electrical components are ETL-listed conforming to UL 916, 1598, 8750, 924 in the U.S.A. and CAN/CSA C22.2 No. 205, 250, and 141 in Canada. In accordance with NEC Code 410.73 (G), this luminaire contains an internal driver disconnect. Damp Location. IC-rated. Finelite products use electronic components that are RoHS compliant, and the mechanical components of the luminaire have been verified to not knowingly contain any restricted substances listed per RoHS Directive 2011/65/EU. Simply add - RLF (Red List Free) or - RLD (Declared) to your part number.

WEIGHT: 16 lbs maximum.

DLC QUALIFIED: Contact factory

WARRANTY: 10-year performance-based warranty on all standard components. Optional accessories such as emergency battery packs are covered by their individual manufacturer warranties.

