

HP-2 / HP-4 Wall Mount Indirect/Direct Installation Instructions

Regressed Luminaires Use Same Instructions

Overview

NOTES

- If luminaire contains a sensor or socket refer to the appropriate Addendum.
- All power connections should be installed according to local/national codes by a Certified Electrician.
- This installation requires **proper support** as each luminaire is being installed.
- **DO NOT attempt to join luminaires together on the floor.** Damage may result when lifted.



HELPFUL
VIDEOS



Louver
Removal



0-10V
Dimming



Effortless
Access



Socket Removal
& Installation



Universal &
Robust Joints



Simple
Plug-Together
Wiring

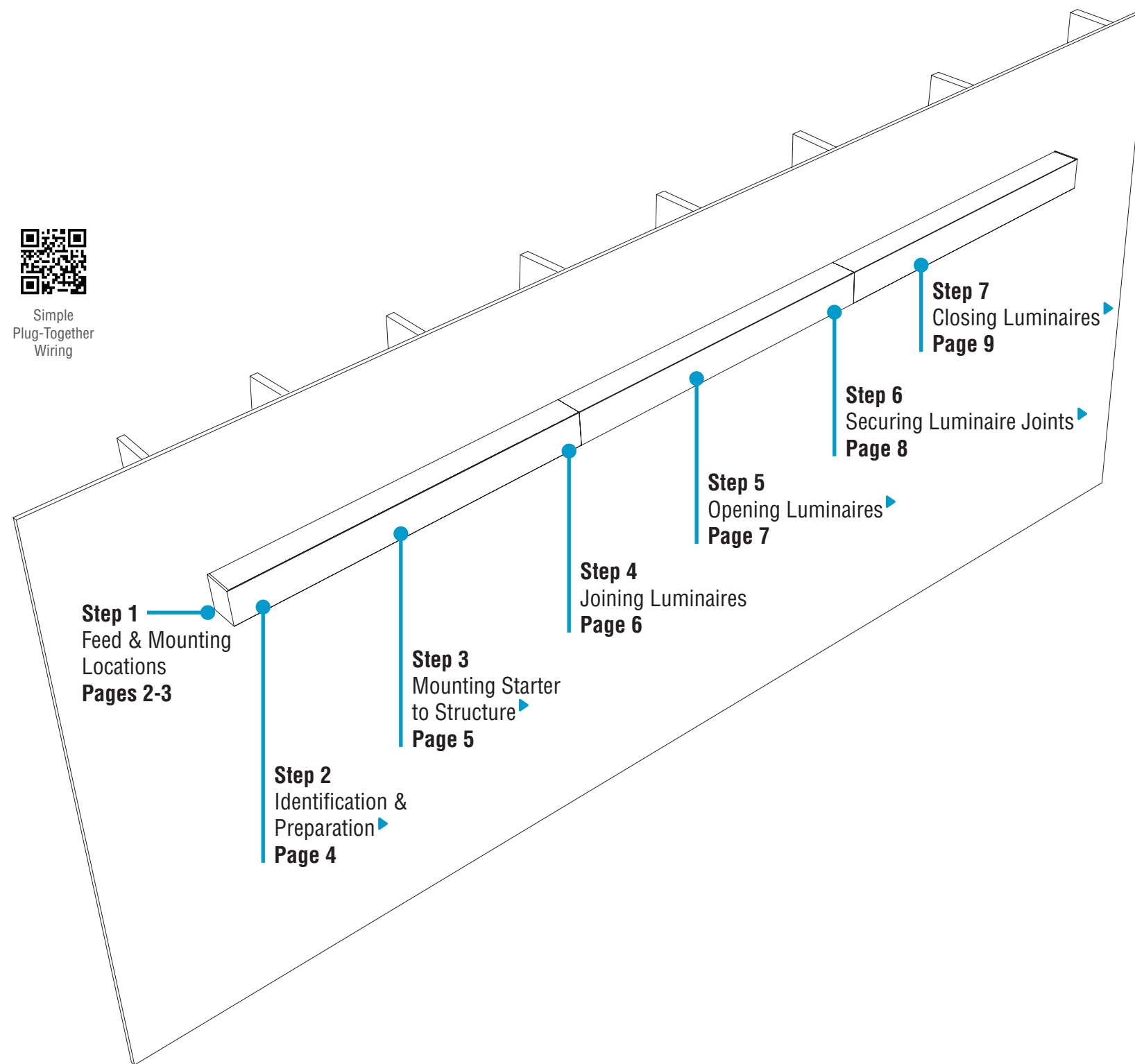

HP-2 / HP-4 Wall Mount Indirect/Direct Installation Instructions

Step 1 - Feed & Mounting Locations

J-Box & Feed Location

- Position luminaire on wall in desired location.
- Mark the top corner of the luminaire, not including the endcap. This is Point A. Use Point A to find and mark feed location.
- Use feed location to center and install 2x4 (single-gang) J-Box.
- Position and install starter wall rail. (See page 3.)

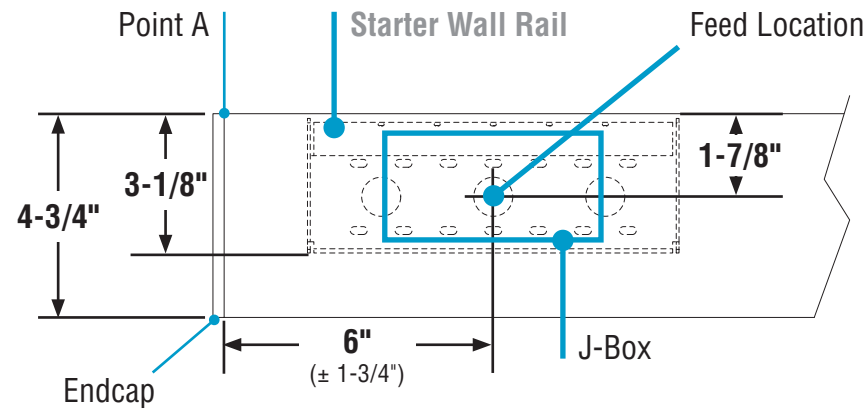

Mounting Locations

X = Luminaire section length
(**X** Measurements **do not include** endcaps)

- Position wall rails as indicated to the right.
- Center of starter wall rail is 6" (± 3/4") from Point A.
- Ensure wall rail mounts are secured to proper structural support.

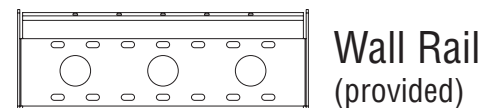
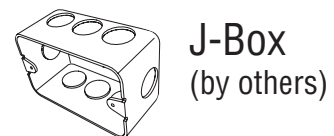
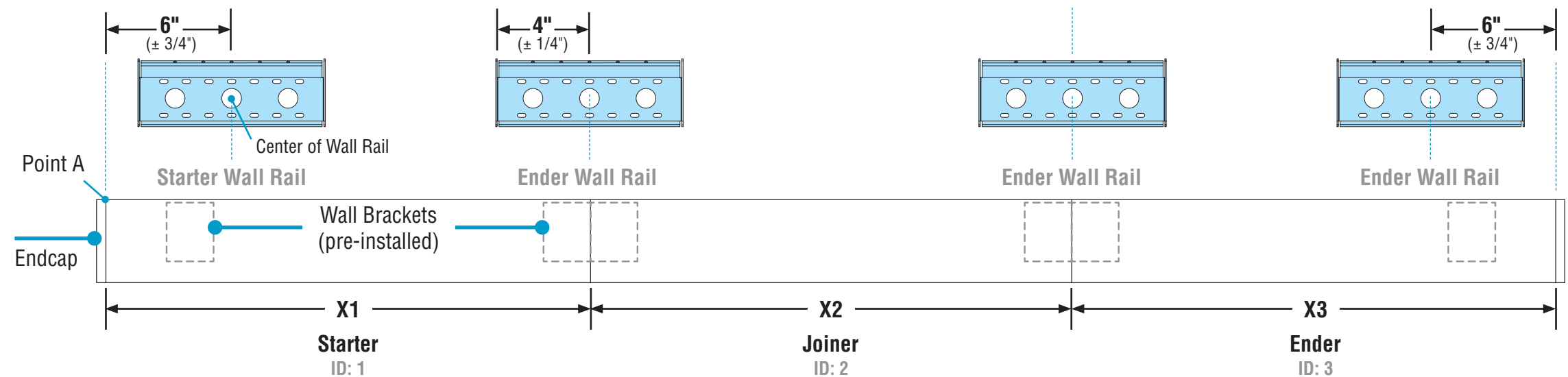

CONTINUED

HP-2 / HP-4 Wall Mount Indirect/Direct Installation Instructions

Step 1 - Feed & Mounting Locations

A. Mount Wall Rail & Power Feed

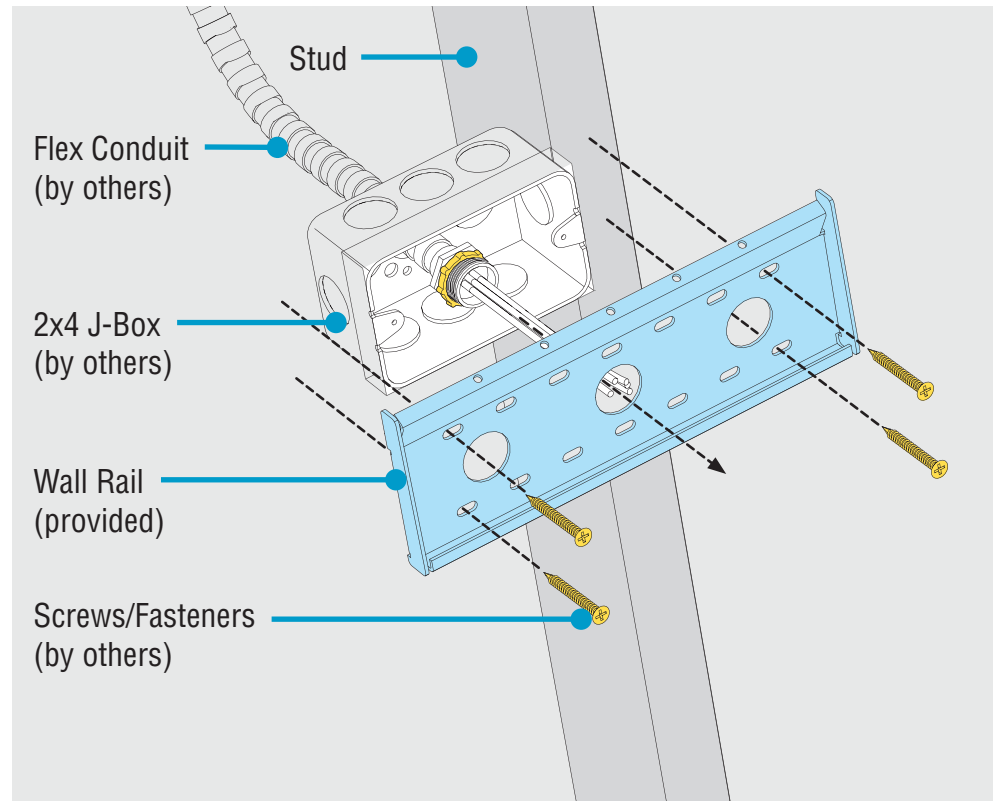

Alternate Mounting Method

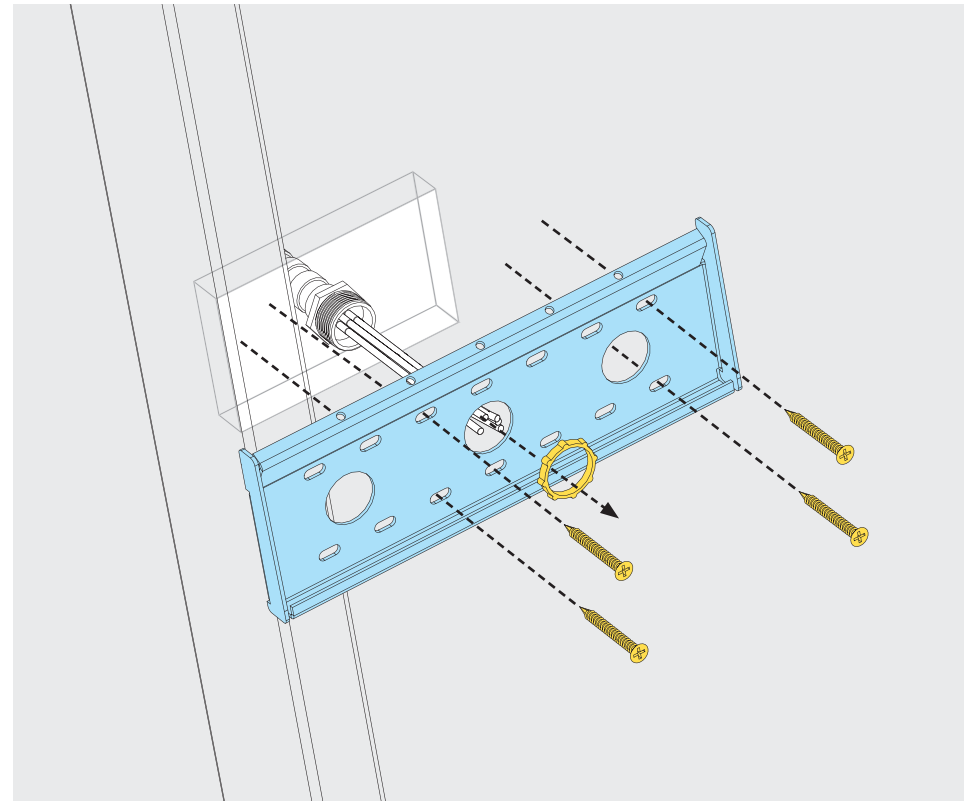

B. Level Wall Rails

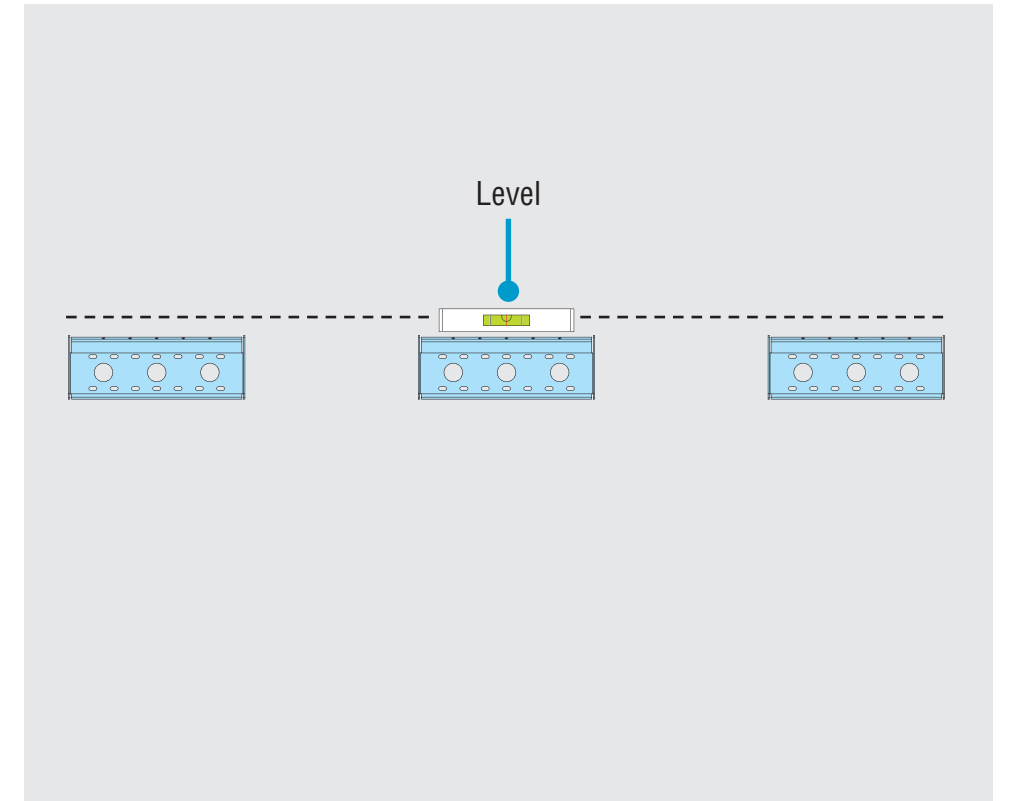

- Use feed location to center and install 2x4 (single-gang) J-Box.
- Level wall rail to ensure proper mounting.
- Install screws through rail and into proper structure support.

- Install all wall rails, ensuring they are level with each other.

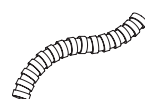
 Flex Conduit
(by others)

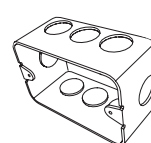
 2x4 J-Box
(by others)

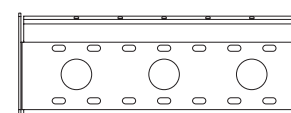
 Wall Rail
(provided)

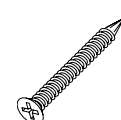
 Screws/Fasteners
(by others)

HP-2 / HP-4 Wall Mount Indirect/Direct Installation Instructions

Step 2 - Identification & Preparation

A. Identify Luminaires



Arrange luminaires in order according to ID# at their install locations.

CAUTION

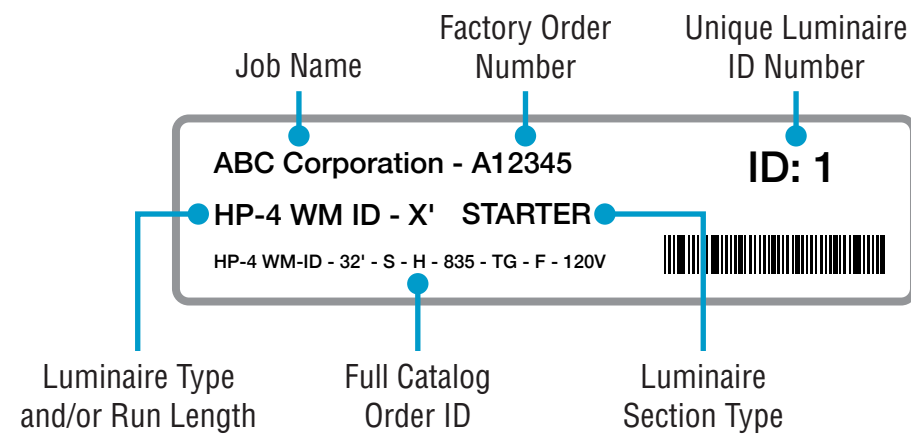

- Identify all luminaires by their ID label that can be found on the box, on the diffuser, and inside the luminaire.
- Remove all luminaires from their box.
- **NOTE:** Exact location of labels in these areas may vary.
- Refer to Record Drawings that can be found in the hardware kit.

B. Remove Downlight Diffusers or Louvers

Remove Diffusers

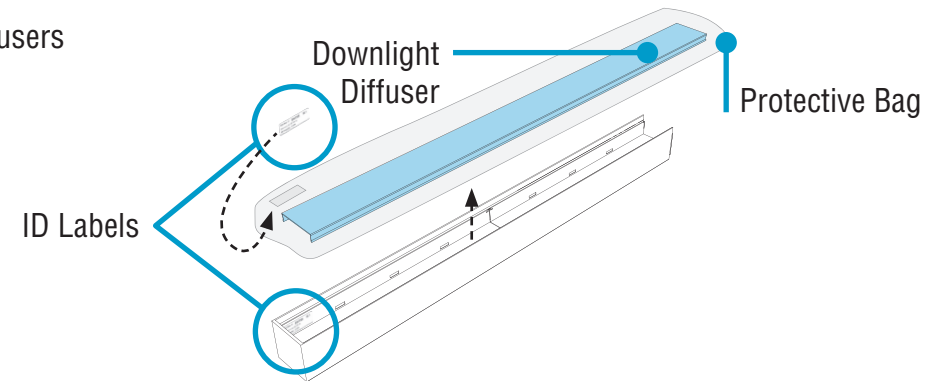

Remove Louvers

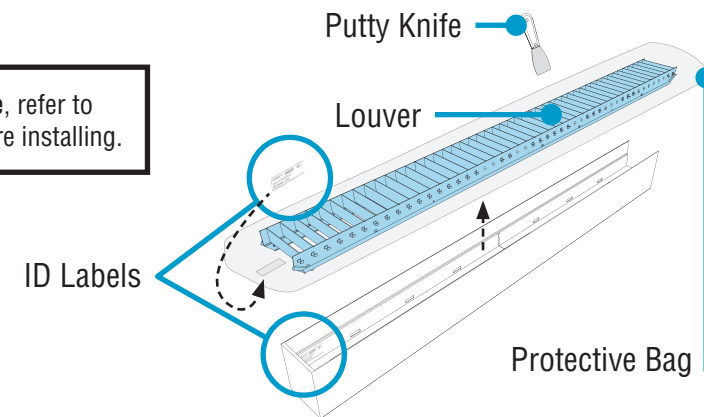

NOTE: For White Cross Blade Baffle, refer to Baffle Tether Addendum before installing.

- Carefully remove all downlight diffusers or louvers, keeping them inside their protective bags.
- **FOR LOUVERS:** Release louvers by inserting the blade of a putty knife approximately 1" down behind louver edges and pry up.
- Set aside all downlight diffusers or louvers to prevent from getting dirty or damaged.
- Ensure downlight diffusers or louvers can be identified back to their corresponding luminaire.

C. Remove Uplight Diffuser

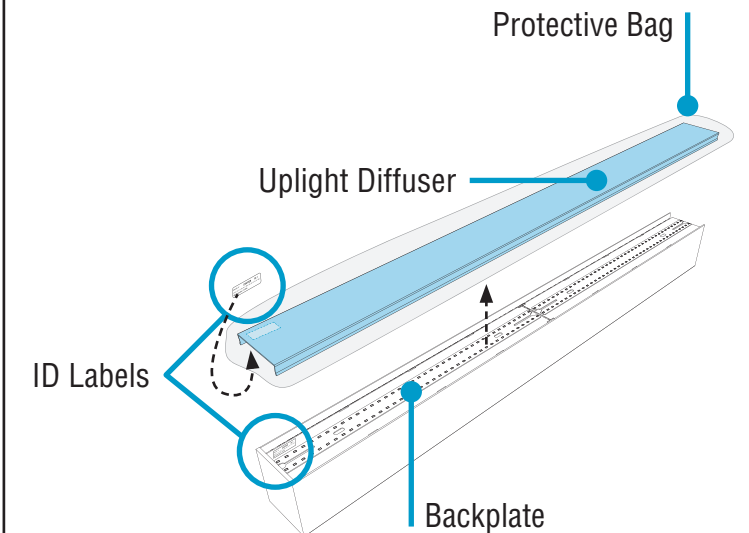

- Carefully remove all upright diffusers, keeping them inside their protective bag.
- Set aside all upright diffusers to prevent from getting dirty or damaged.
- Ensure upright diffusers can be identified back to their corresponding luminaire.

Kitted Hardware

- Finelite has provided items listed here, with their Finelite part numbers. These items can be found in separate boxes shipped with the luminaire.
- Account for all parts and set aside until they are needed.
- All other hardware needed for this installation will be by others.

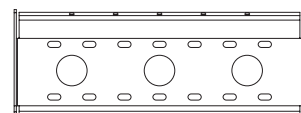

Wall Rail
Part# 20081
Feed & Mounting Locations
pp. 2-3, Step 1



#8-18 x 1/4" Mounting Screw
Part# 94059
Mounting Starter to Structure
p. 5, Step 3
Closing Luminaires
p. 9, Step 7

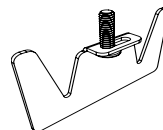

Yoke Bracket
Part# 45042
#10-32 x 5/8" Yoke Screw
Part# 94144
Securing Luminaire Joints
p.8, Step 6



Louver Removal

HP-2 / HP-4 Wall Mount Indirect/Direct Installation Instructions

Step 3 - Mounting Starter to Structure

A. Mount Starter to Structure

WIRING LEGEND		
Black	Hot	Line Voltage
White	Neutral	Line Voltage
Green	Ground	
Grey	Dimming	0-10V DC
Purple	Dimming	0-10V DC

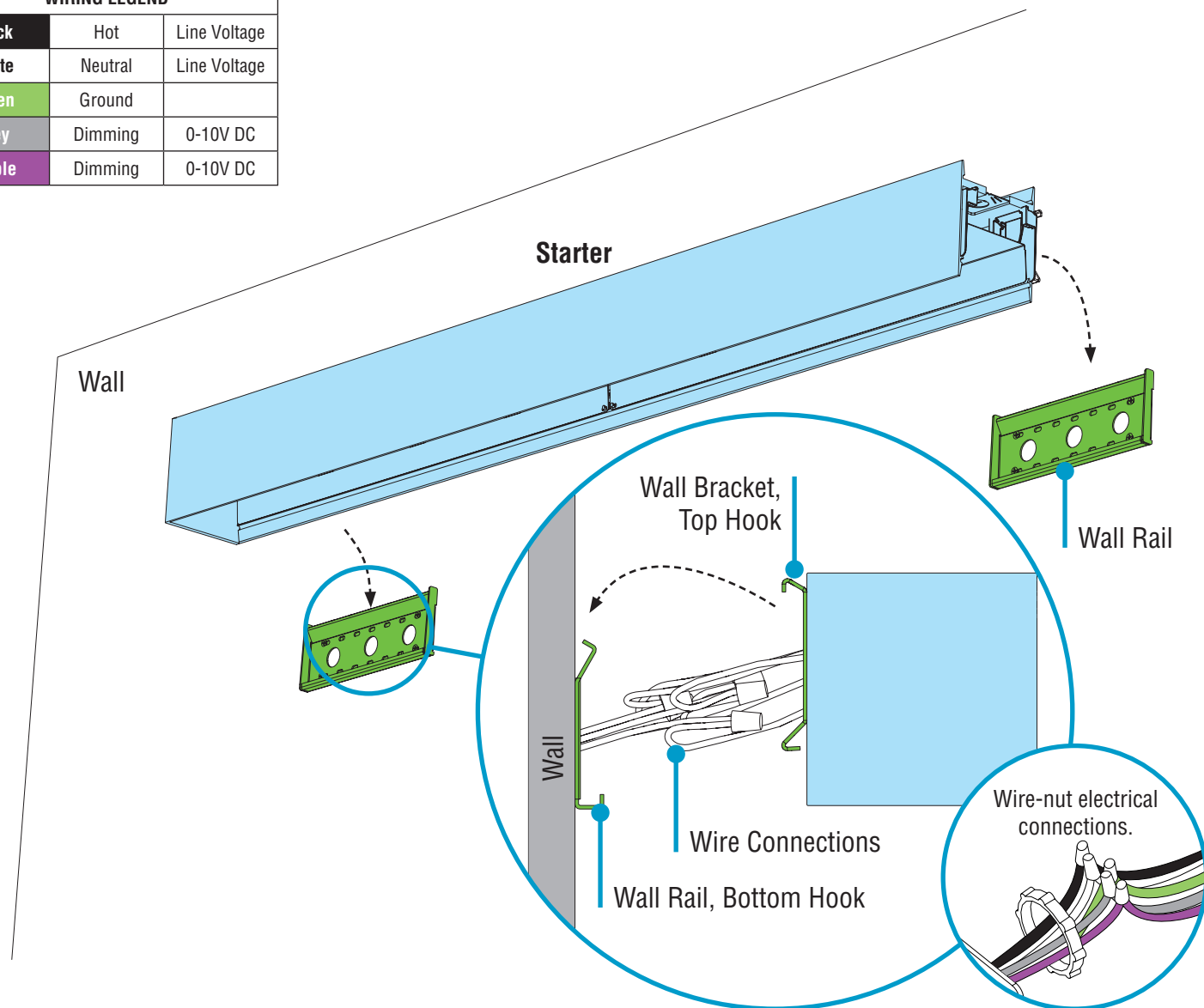

- While properly supporting luminaire, make electrical connections and push complete connections into J-Box.
- Position starter luminaire in place so that the top and bottom hooks of the wall bracket engage with the top and bottom hooks of the wall rail.

B. Secure Starter to Wall Rail

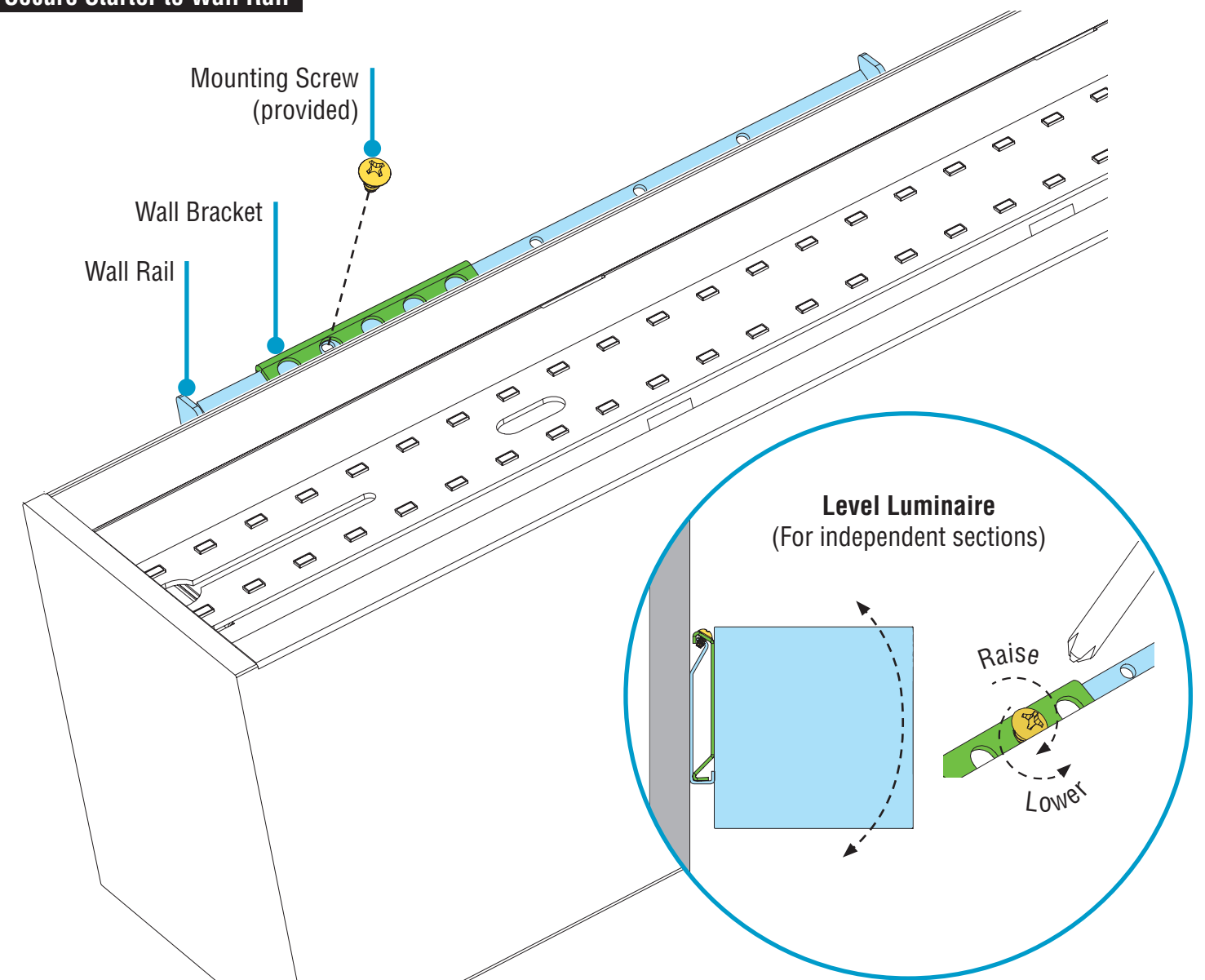

- If there is no joiner/ender, then secure starter luminaire to wall rail with a mounting screw and perform leveling. Tightening the screw raises and loosening the screw lowers the front edge of the luminaire. **PROCEED TO STEP 7, B.**
- If continuing with a joiner/ender luminaire, do not perform leveling yet.

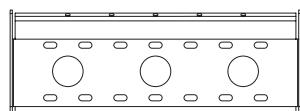

Wall Rail
(provided)



Mounting Screw
#8-18 x 1/4" (provided)



0-10V
Dimming

HP-2 / HP-4 Wall Mount Indirect/Direct Installation Instructions

Step 4 - Joining Luminaires

A. Mount Joiner/Ender to Structure



CAUTION

DO NOT attempt to join luminaires together on the floor. Damage may result when lifted. Follow these instructions.

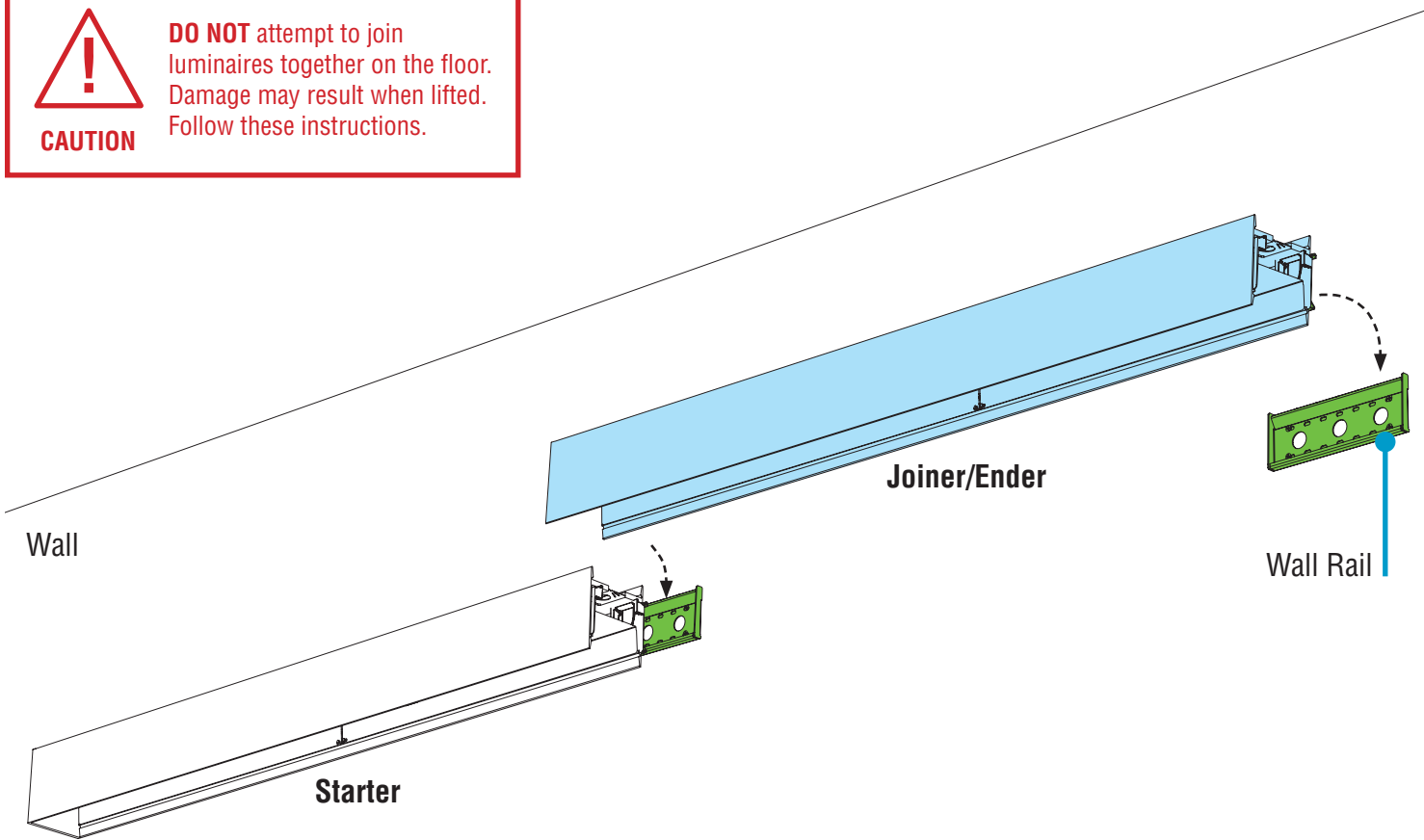

B. Join Luminaires



CAUTION

Once luminaires are aligned together, **joiner luminaire is not yet secure**. Ensure it does not slide off as it rests on the starter luminaire.

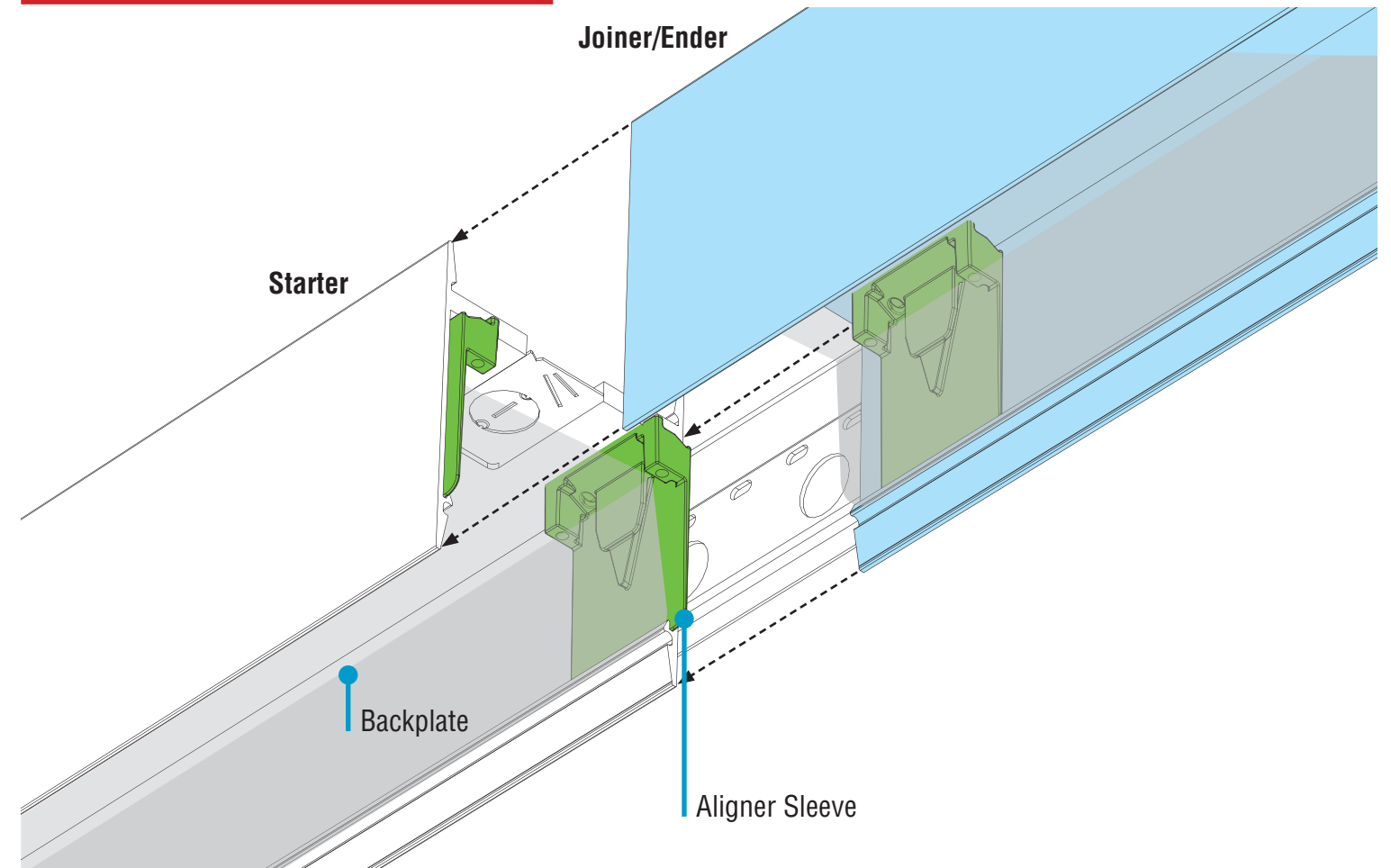

- Maneuver joiner/ender luminaire to wall and engage top and bottom hooks of the wall bracket with the top and bottom hooks of the wall rail.

- Align joiner/ender with aligner sleeves on starter and slide together. Be careful not to damage any wiring.
- If necessary, **lift** both luminaires, then slide together.

HP-2 / HP-4 Wall Mount Indirect/Direct Installation Instructions

Step 5 - Opening Luminaires

Release Downlight Backplates

Putty Knife Option

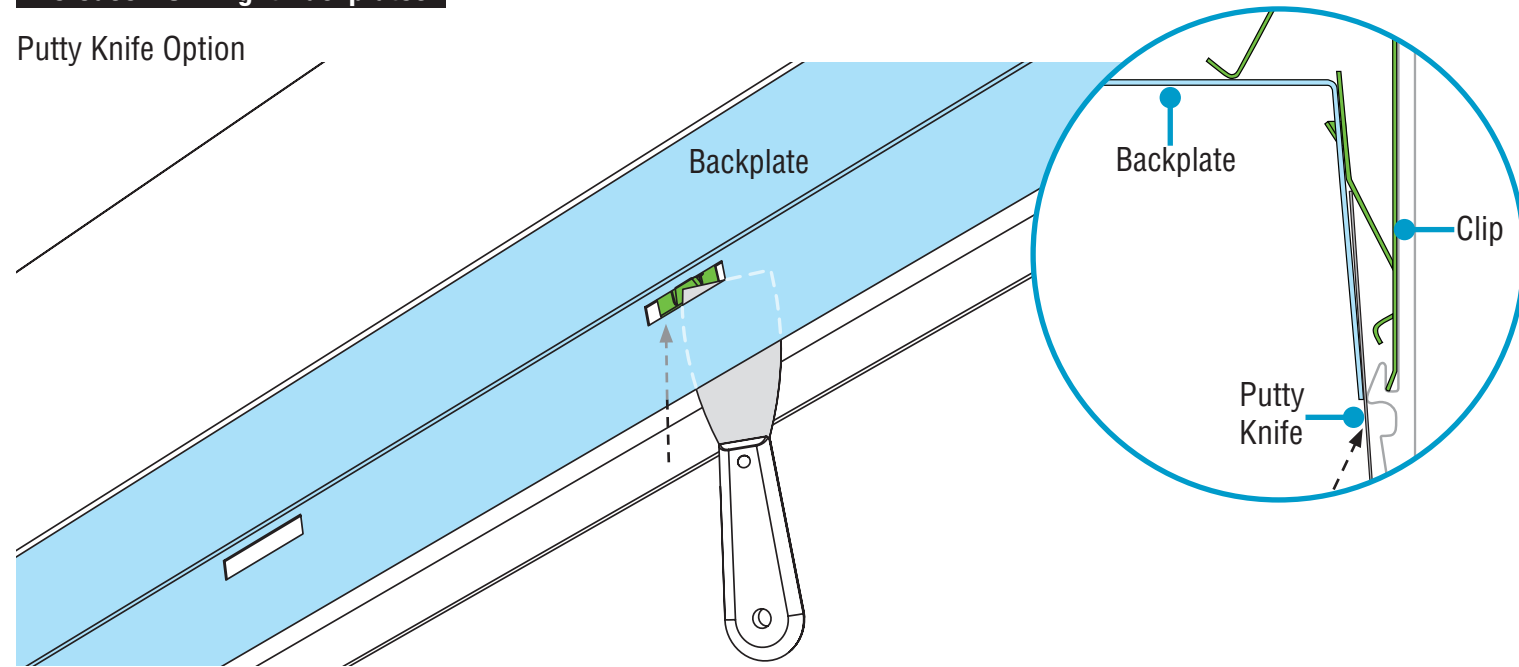

Flathead Screwdriver Option

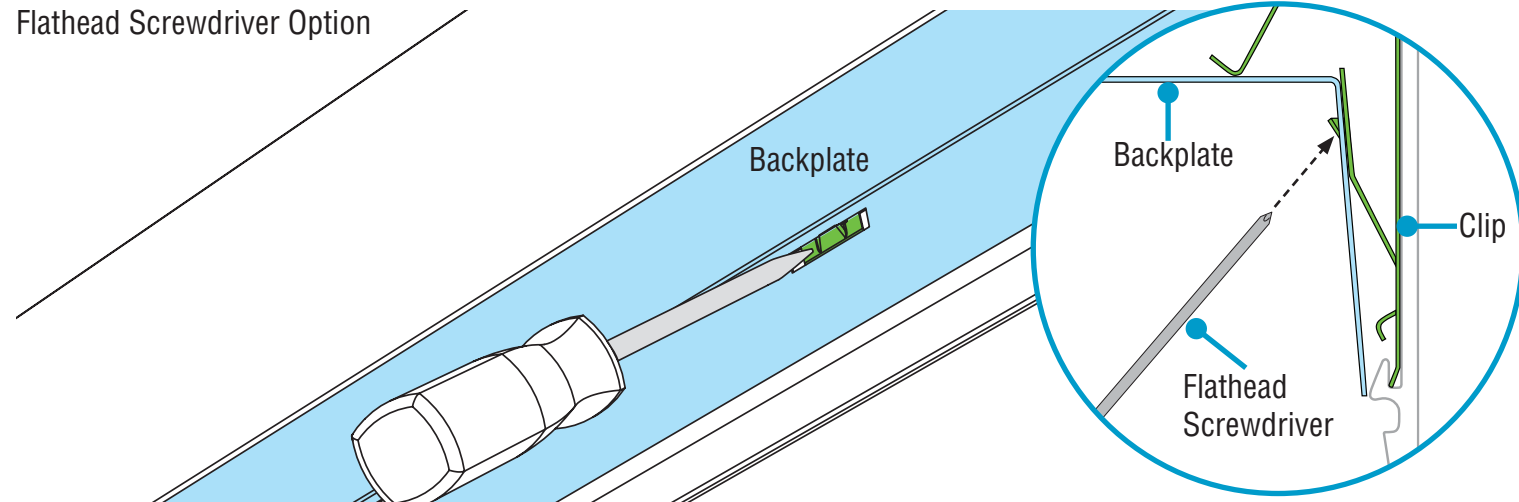

- **NOTE:** For independent luminaires, backplates do not need to be released.
- Release the backplates from clips by sliding the blade of a putty knife behind backplate edges.
- To use a flathead screwdriver, press end of screwdriver (from inside the luminaire) against the clip, until the backplate is released.

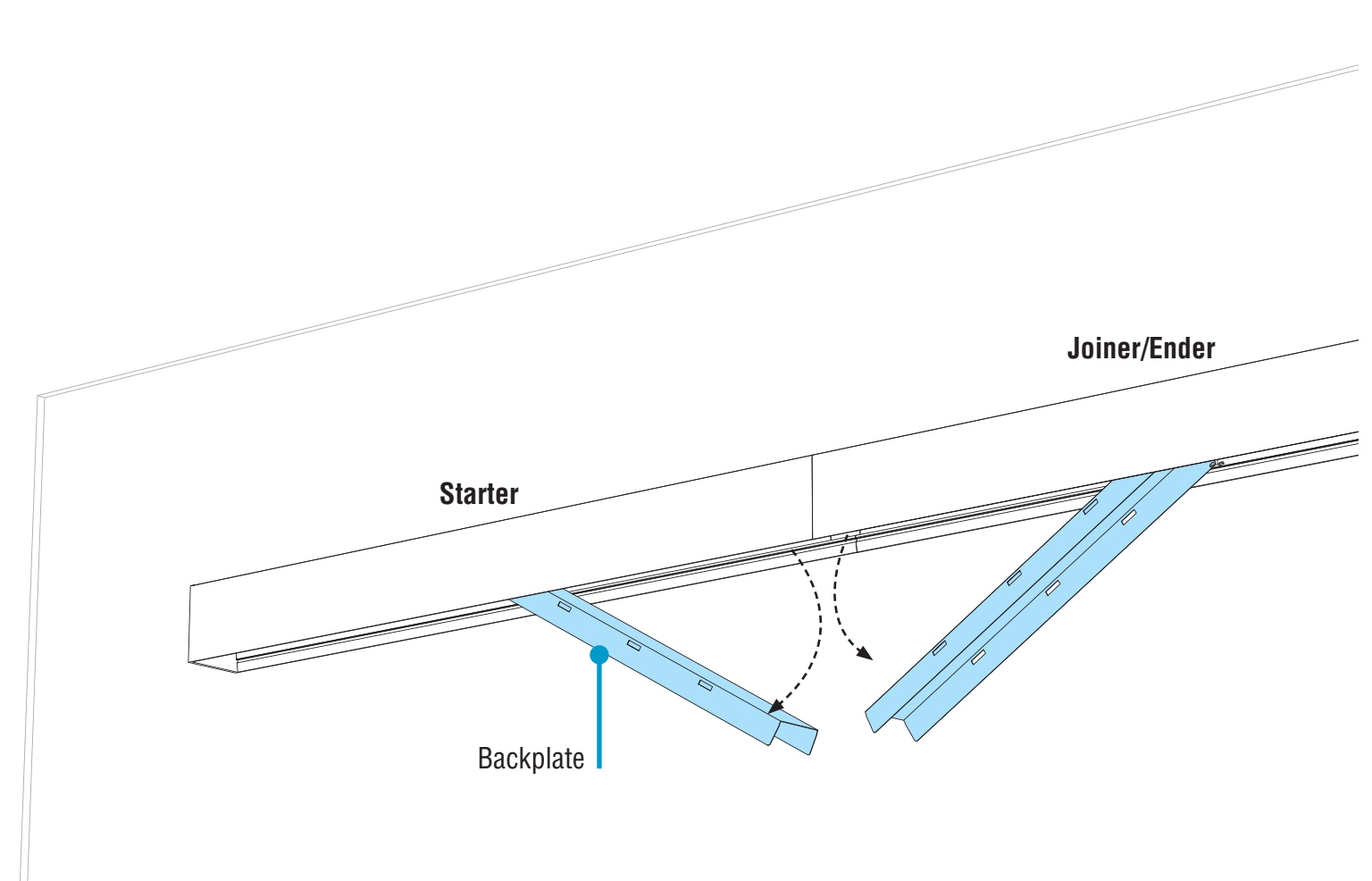

- Carefully rotate backplates out **at the joints only** and let them hang from luminaire body.



Effortless
Access

HP-2 / HP-4 Wall Mount Indirect/Direct Installation Instructions

Step 6 - Securing Luminaire Joints

A. Secure Joint with Yoke Brackets

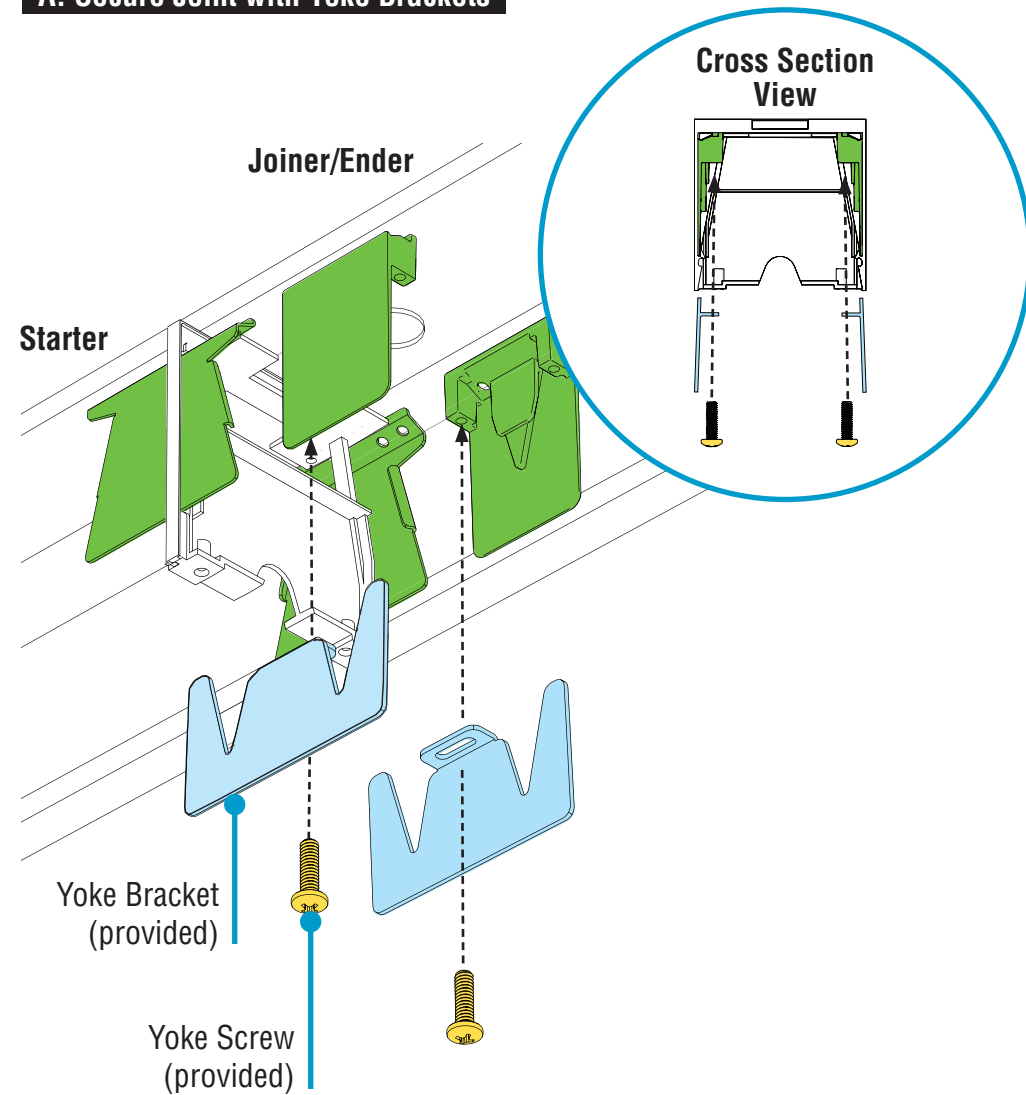

- **FOR SENSOR OR SOCKET:** If luminaire contains a sensor or socket at joint, refer to page 4 of appropriate Addendum before Securing Luminaire Joints.
- Before installing yoke brackets, ensure the joining ends of luminaires meet flush and square.
- **CRITICAL:** Ensure yoke brackets properly engage with aligner sleeves.
- Secure joint by threading (but not yet tightening) yoke screws through yoke brackets and into the aligner sleeves.

IN ALIGNMENT

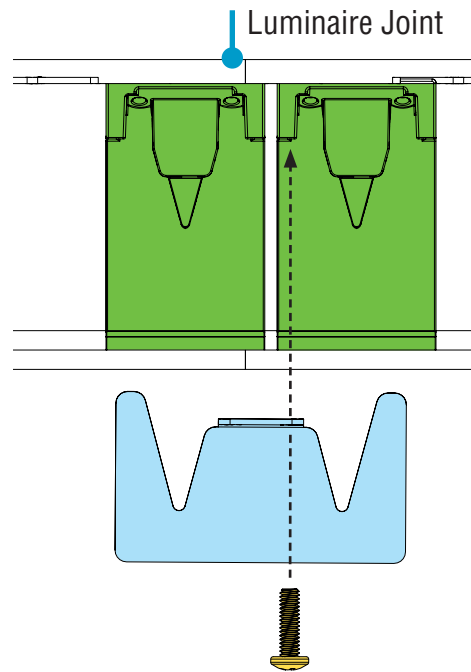

YOKE SCREW ALIGNMENT Bottom-Up View

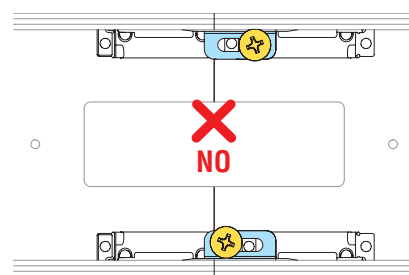

NOTE: Yoke screws should be installed directly across from each other, not diagonally, and in holes furthest from the joint line. One yoke screw per one yoke bracket.

CORRECTLY INSTALLED

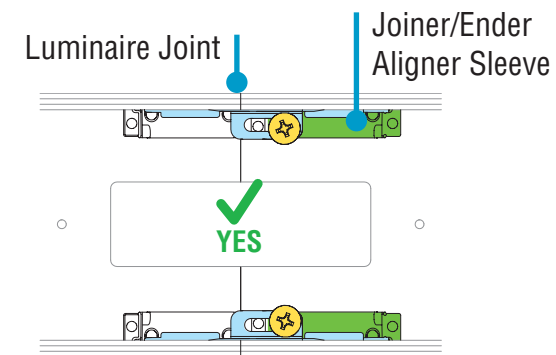
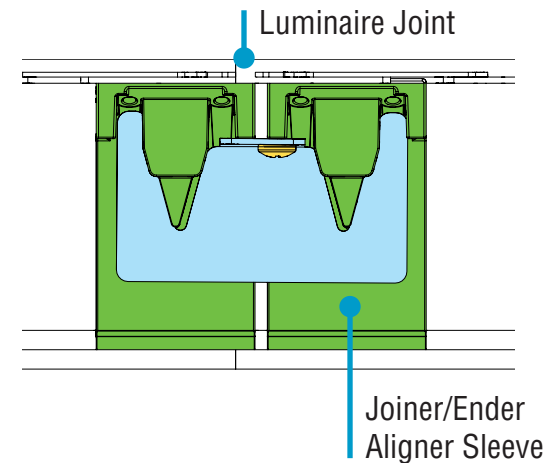

B. Make Electrical Connections

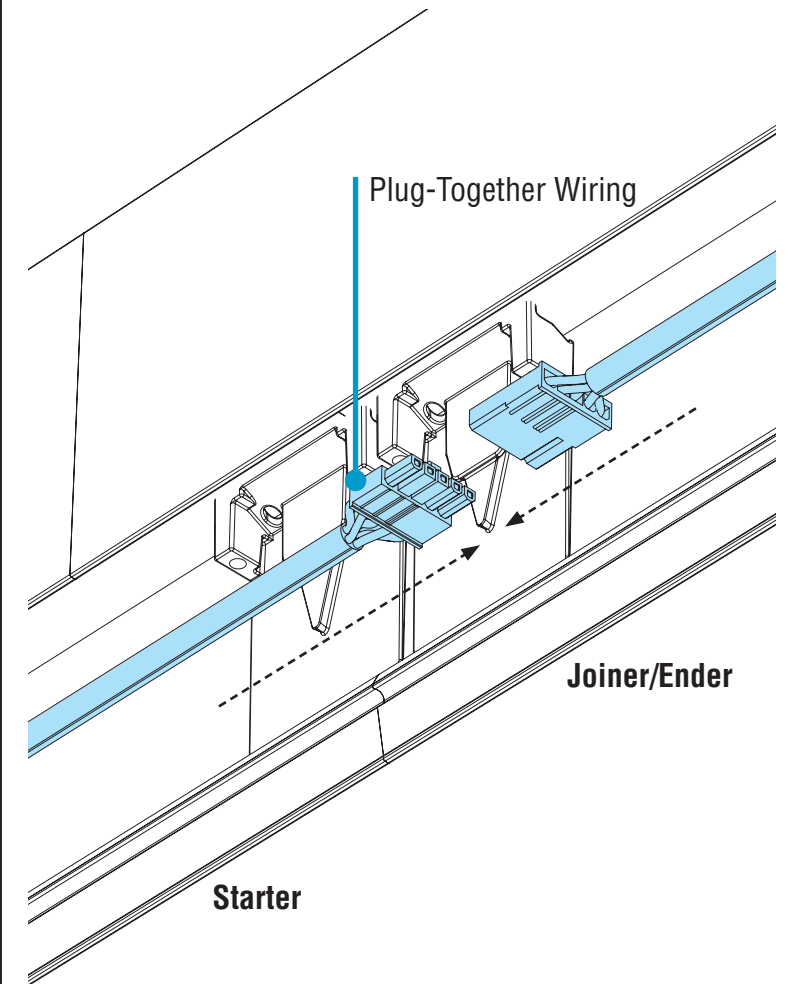

- Connect plug-together wiring.

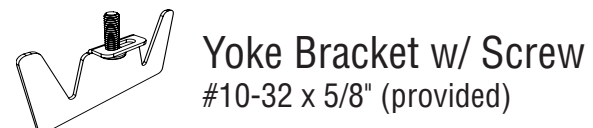

HP-2 / HP-4 Wall Mount Indirect/Direct Installation Instructions

Step 7 - Closing Luminaires

A. Secure & Level Luminaires

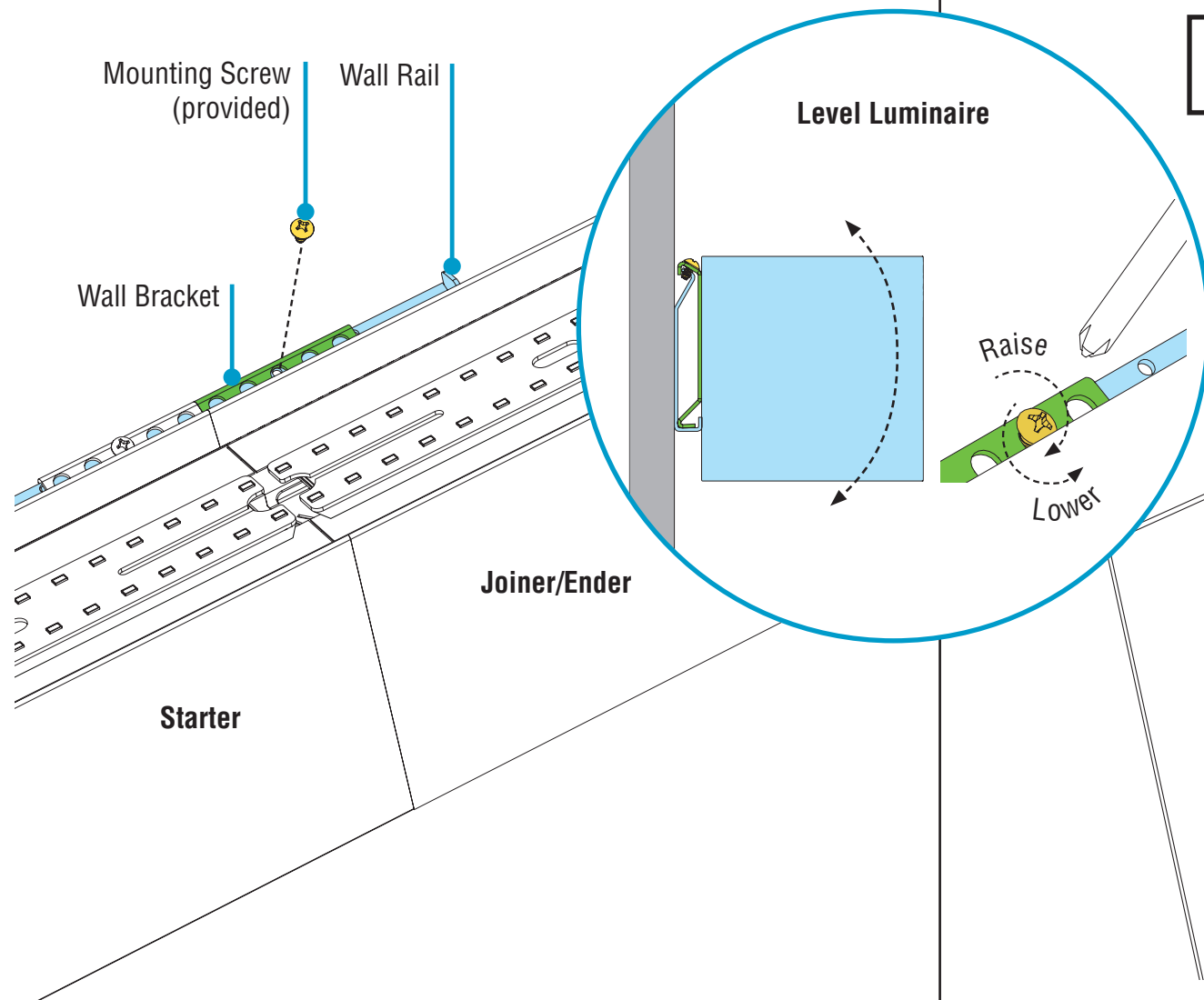

B. Final Step - Replace Backplates & Diffusers or Louvers

NOTE: For White Cross Blade Baffle, refer to Baffle Tether Addendum before installing.

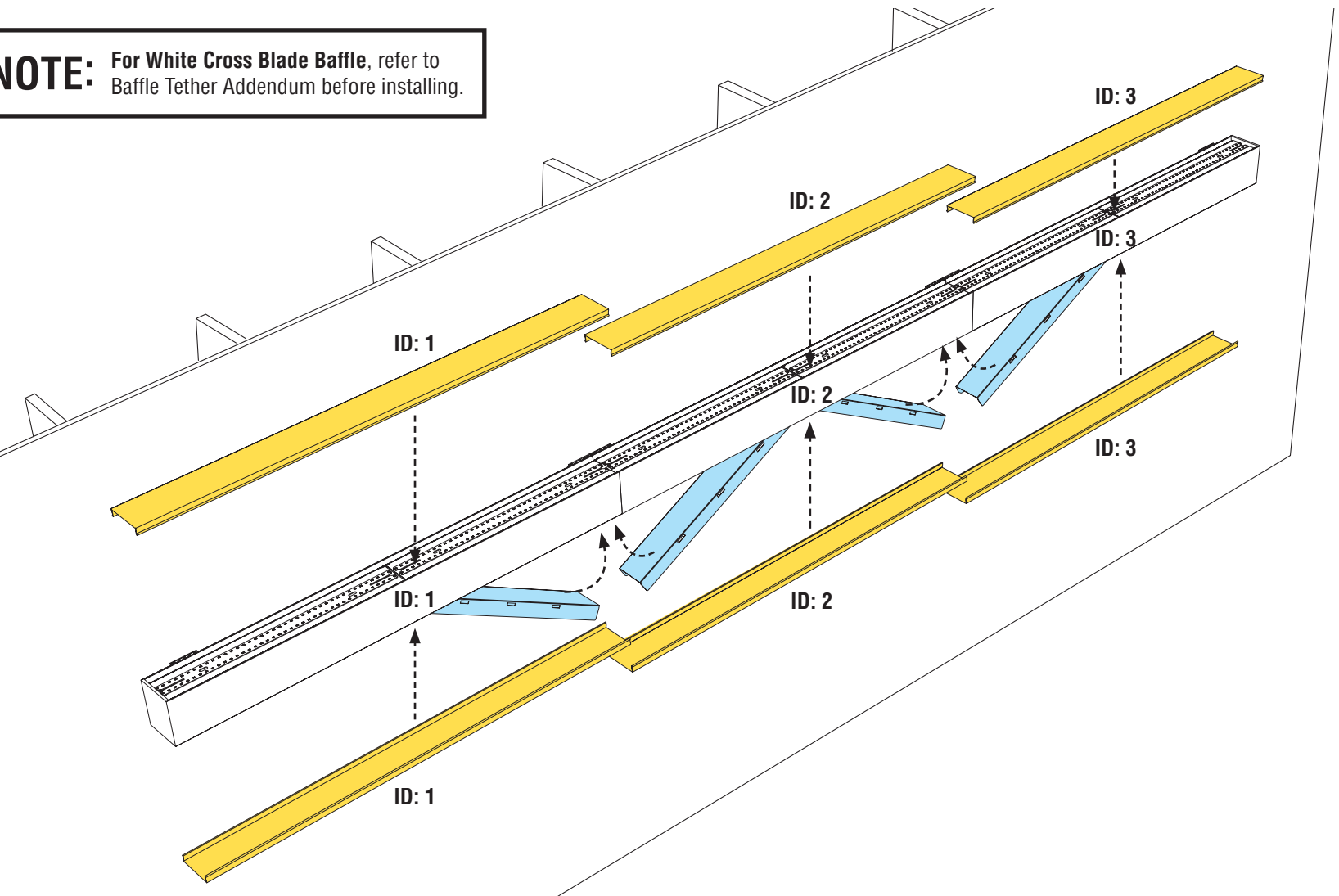

- Secure joiner/ender luminaire to wall rail with a mounting screw.
- Use mounting screws to level all luminaire sections. Tightening the screw raises and loosening the screw lowers the front edge of the luminaire.
- Tighten yoke screws¹ until joint seam of luminaires is closed.

- **NOTE:** If your installation includes a battery backup, please see addendum (98333) that should be included with your kitting package.
- **FOR SENSOR OR SOCKET:** If luminaire contains a sensor or socket at joint, refer to page 5 of appropriate Addendum before Closing Luminaires.
- Reinstall downlight backplates by rotating back into luminaire body and snapping into clips.

- Remove diffusers or louvers from their protective plastic bags.
- **CAUTION:** Wear gloves to keep diffuser or louver surface clean.
- **CRITICAL:** Be sure to install correct diffuser or louver to its corresponding luminaire ID.
- **NOTE:** For White Cross Blade Baffle, refer to Baffle Tether Addendum before installing.
- Install diffusers or louvers into luminaire body, ensuring they snap back into place.
- Turn power on to luminaire.

 **Mounting Screw**
#8-18 x 1/4" (provided)

¹ Screwdriver with 6" bit required.



Socket Removal
& Installation