

HPO Direct and Indirect/Direct (Flush or Round) Installation Instructions Overview

NOTES

- All power connections should be installed according to local/national codes by a Certified Electrician.
- This installation requires **proper support** as each luminaire is being installed.
- **DO NOT attempt to join luminaires together on the floor.** Damage may result when lifted.



HELPFUL
VIDEOS



0-10V
Dimming



Simple
Plug-Together
Wiring



Robust
Joint

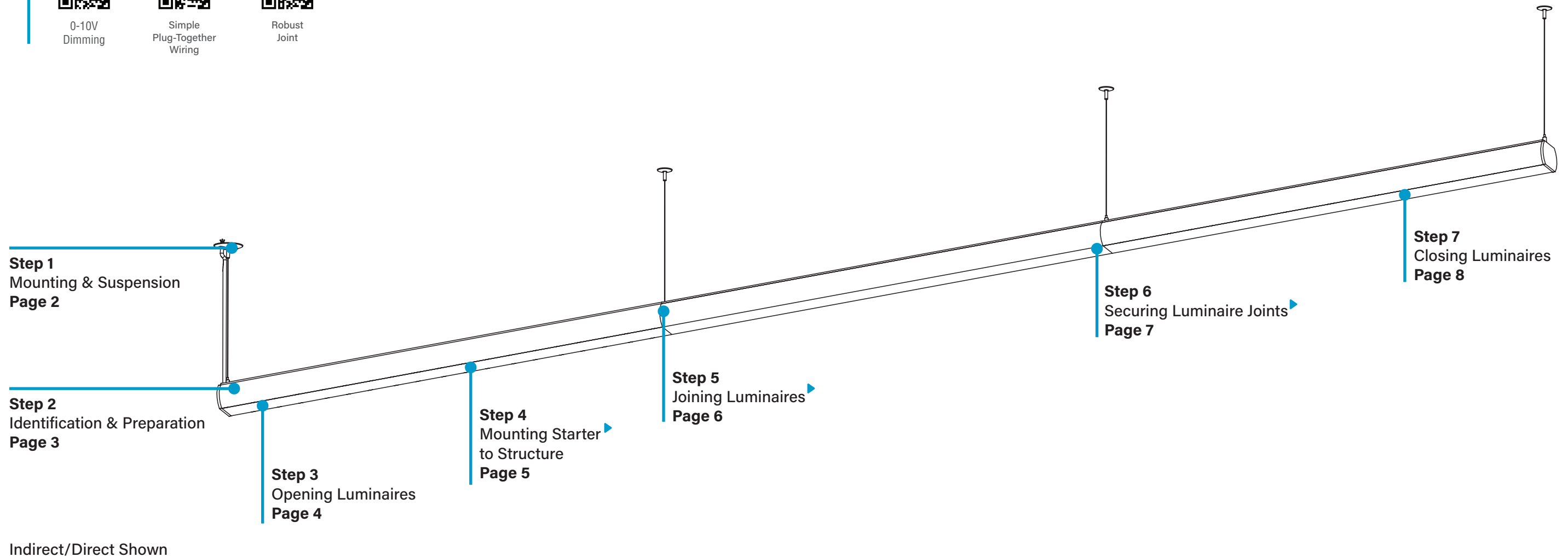

HPO Direct and Indirect/Direct (Flush or Round) Installation Instructions

Step 1 - Mounting & Suspension

Mounting Options

Option 1 T-Bar Mounting - GridBox™ and Caddy Clips

- Install GridBox™ and electrical conduit at feed locations.
- Install caddy clips at mounting point locations.
- All caddy clips are to be secured to structure, per local building codes.

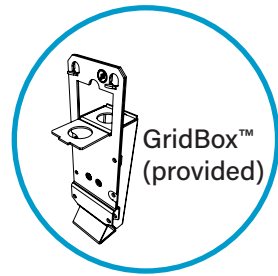

or

Option 2 Drywall (C4) or other hard surfaces* - J-Box and Anchor Bolts

- Install J-Box and electrical conduit at feed locations.
- Install anchor bolts at mounting point locations.
- All anchor bolts are to be secured to structure, per local building codes.

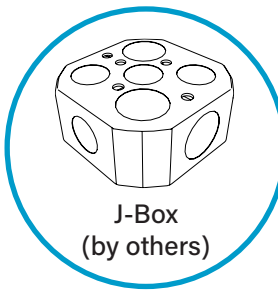

* Other hard surfaces include: wood, sheet metal panels, steel beams, concrete, or masonry. Use hardware appropriate for each surface material type.

Suspension Locations

X = Suspension Dimensions

Refer to Record Drawings and building plans to determine exact mounting, suspension points, and power feed locations.

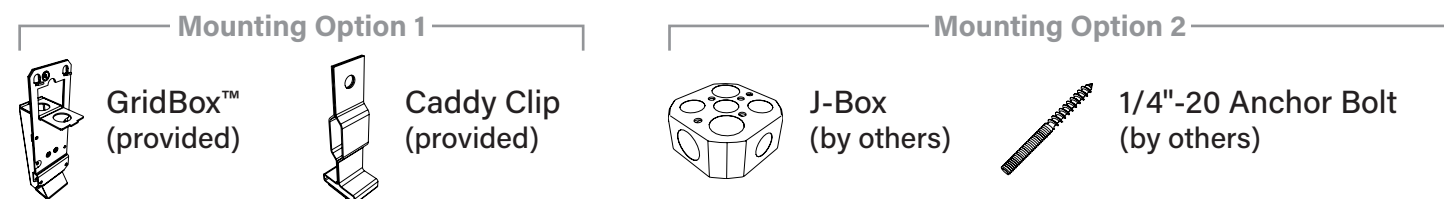
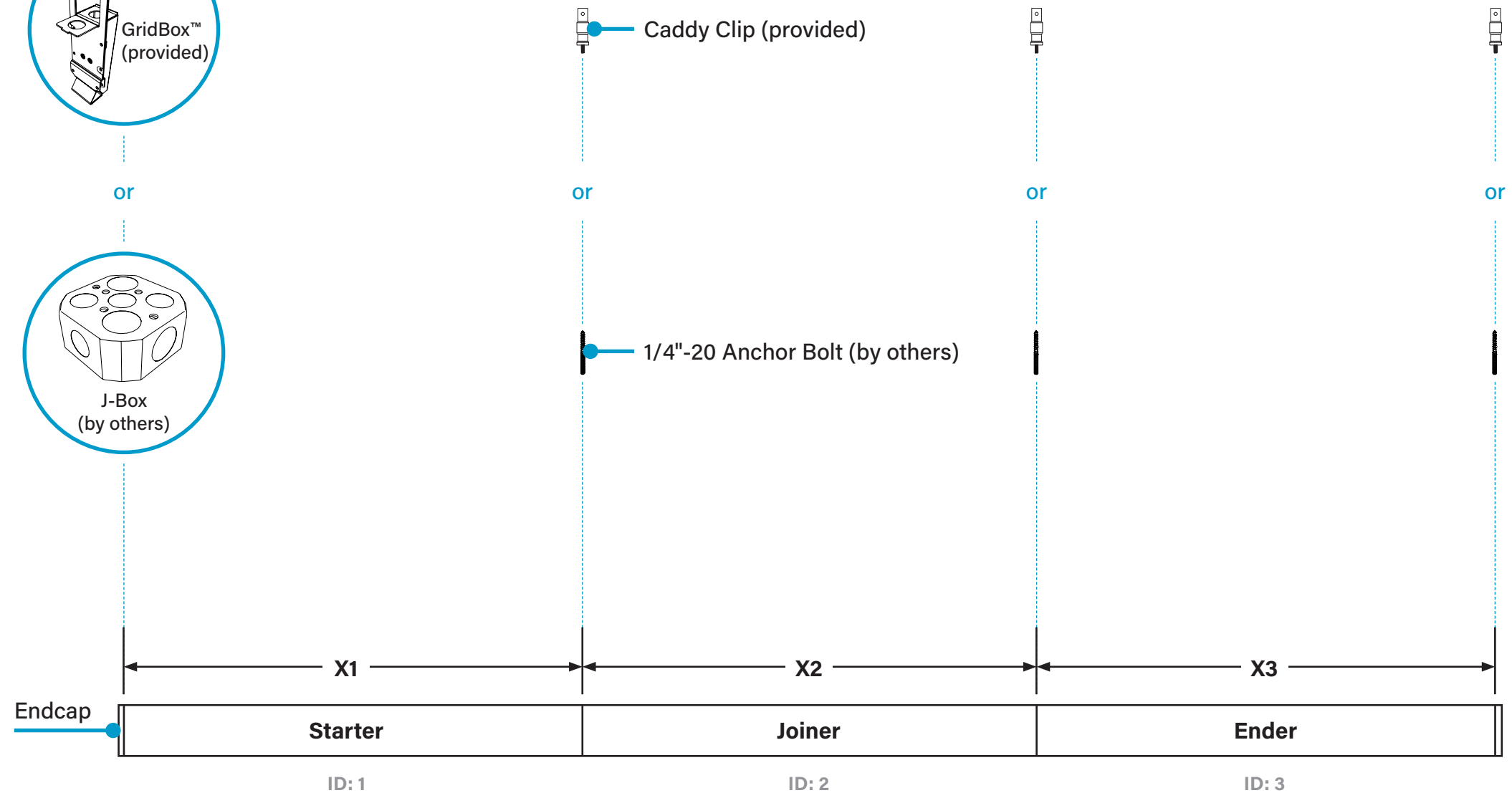

HPO Direct and Indirect/Direct (Flush or Round) Installation Instructions

Step 2 - Identification & Preparation

A. Identify Luminaires

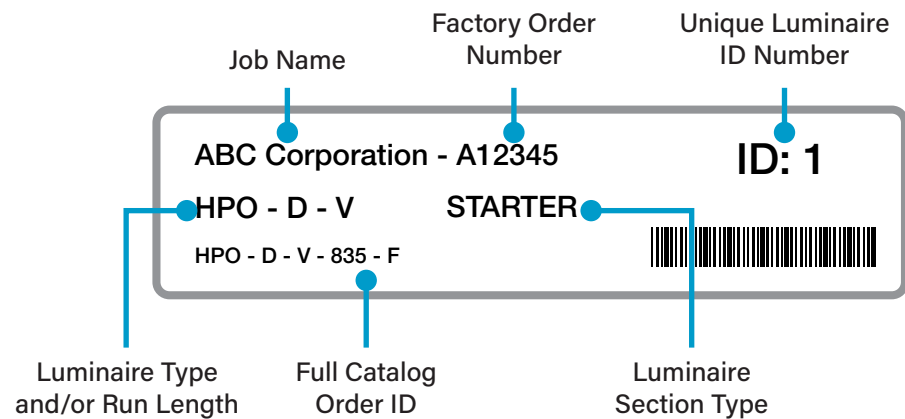
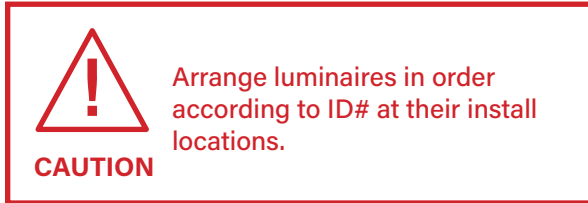

- Identify all luminaires by their ID label that can be found on the box, the protective bag, and inside the luminaire.
- **NOTE:** Exact location of labels in these areas may vary.
- Remove all luminaires from their box.
- Refer to Record Drawings that can be found in the hardware kit.

B. Remove Up & Downlight Diffusers

Uplight Diffusers

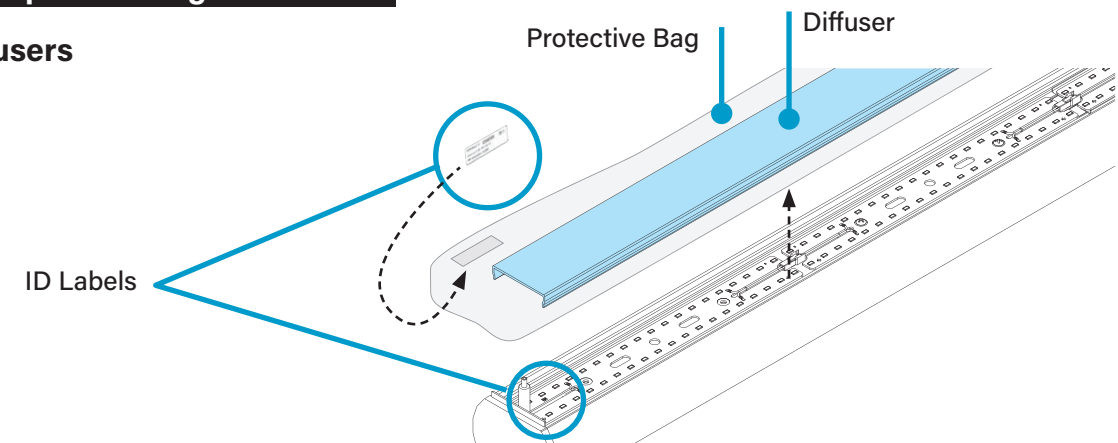

Downlight Diffusers

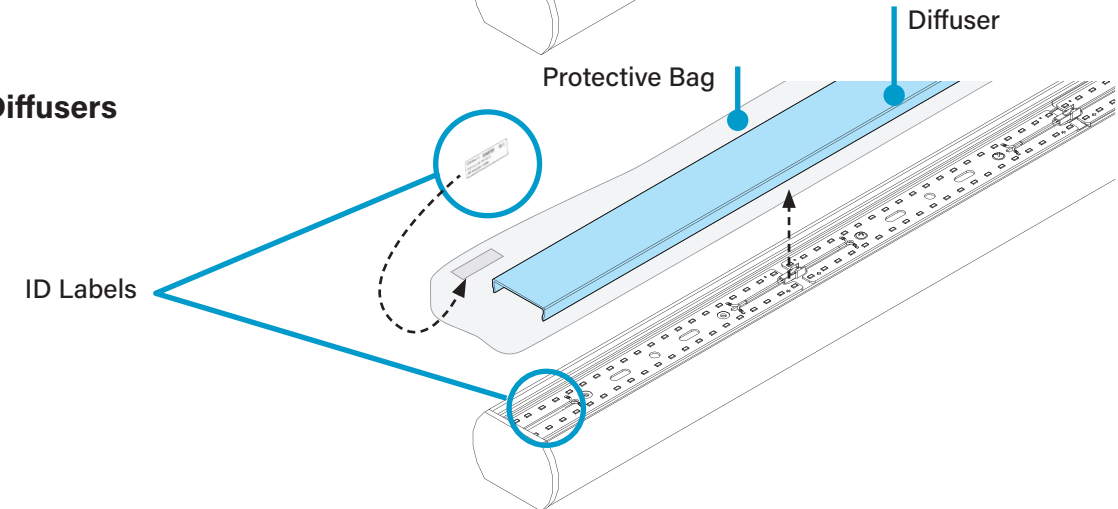







- Carefully remove all diffusers, keeping them inside their protective bags.
- Set aside all diffusers to prevent them from getting dirty or damaged.
- Ensure diffusers can be clearly identified back to their corresponding luminaire.

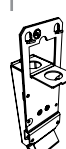

Kitted Hardware

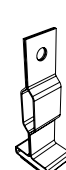

- Finelite has provided items listed here, with their Finelite part numbers. These items can be found in separate boxes shipped with the luminaire.
- Account for all parts and set aside until they are needed.
- All other hardware needed for this installation will be by others.



Mounting Option 1

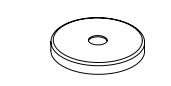

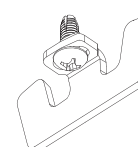
 GridBox™ Part# 89159	 3-1/2" Canopy Part# 89191
 Dual GridBox™ Part# 89199 Mounting & Suspension p. 2, Step 1	 3-1/2" Dual Feed Canopy Part# 89192 Mounting Starter to Structure p. 5, Step 4 Joining Luminaires p. 6, Step 5
 Caddy Clip C1 Ceiling - Part# 94001 C2 Ceiling - Part# 94020 C3 Ceiling - Part# 94029 Mounting & Suspension p. 2, Step 1	 3-1/2" T-Bar Support Canopy Part# 89193 Mounting Starter to Structure p. 5, Step 4 Joining Luminaires p. 6, Step 5

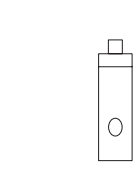
Mounting Option 2

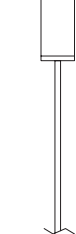
 5" Canopy Part# 94085	 5" Dual Feed Canopy Part# 94145 Mounting Starter to Structure p. 5, Step 4 Joining Luminaires p. 6, Step 5
 2" Drywall Support Canopy Part# 94017 Mounting Starter to Structure p. 5, Step 4 Joining Luminaires p. 6, Step 5	

 Yoke Bracket Part# 30007	 Washer Part# 94111
#10-32 x 5/8" Screw icon" data-bbox="563 815 605 845"/> #10-32 x 5/8" Screw Part# 94144 Securing Luminaire Joints p. 7, Step 6	 Gripper Part# 68129 Mounting Starter to Structure p. 5, Step 4 Joining Luminaires p. 6, Step 5

 Cable Bushing Part# 94014	 Aircraft Cable 50" - Part# 94515-12 (Std.) 100" - Part# 94515-14 150" - Part# 94515-18 Mounting Starter to Structure p. 5, Step 4 Joining Luminaires p. 6, Step 5
 Safety Crimp Part# 94514 Closing Luminaires p. 8, Step 6	

 Slip Ring w/ Set Screw Part# 94015 Mounting Starter to Structure p. 5, Step 4 Joining Luminaires p. 6, Step 5	 Safety Bar Part# 93500 Closing Luminaires p. 8, Step 6
---	--

HPO Direct and Indirect/Direct (Flush or Round) Installation Instructions

Step 3 - Opening Luminaires

Remove Backplates Top-Down View

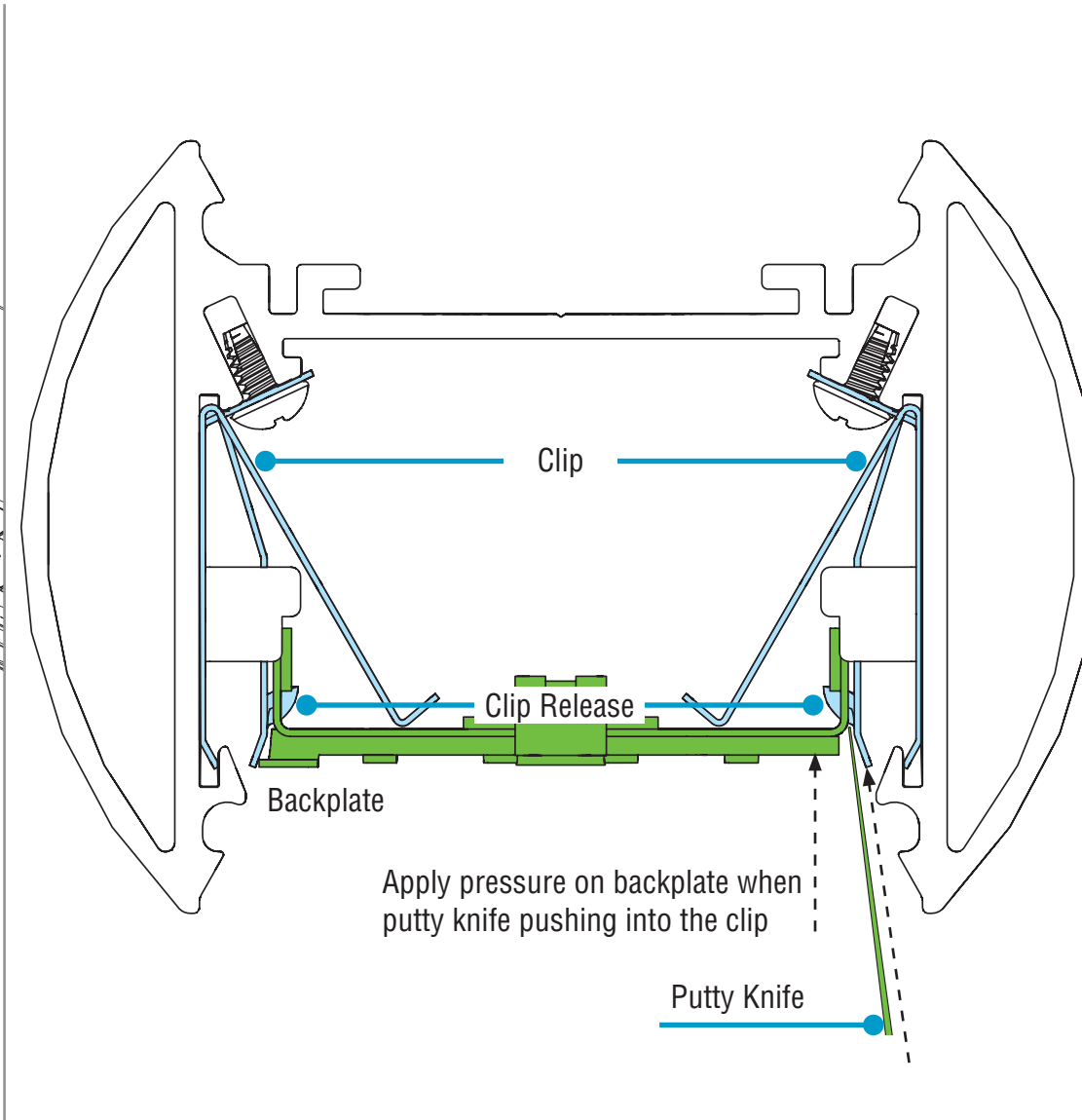
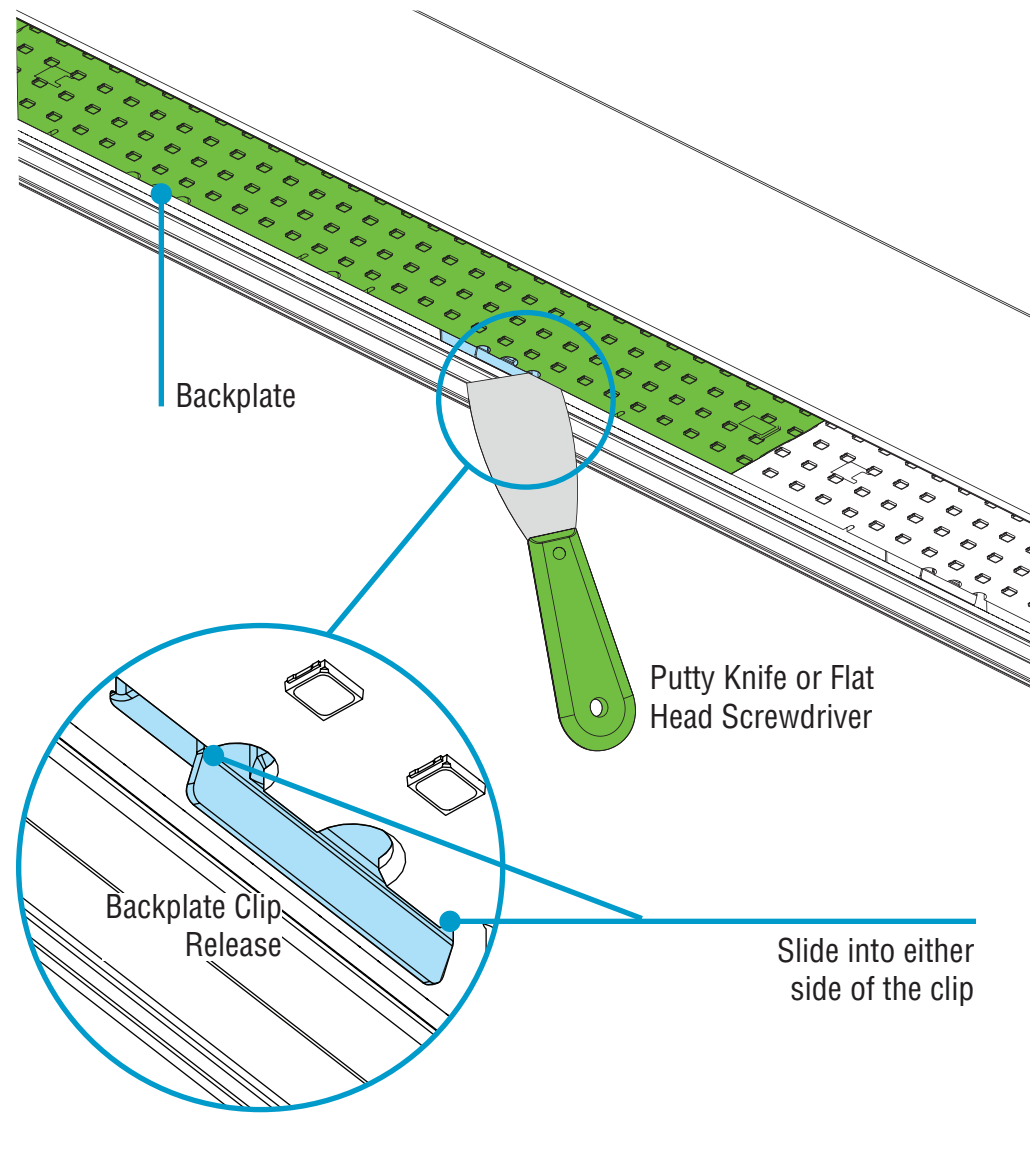

Remove Downlight Backplates Bottom View

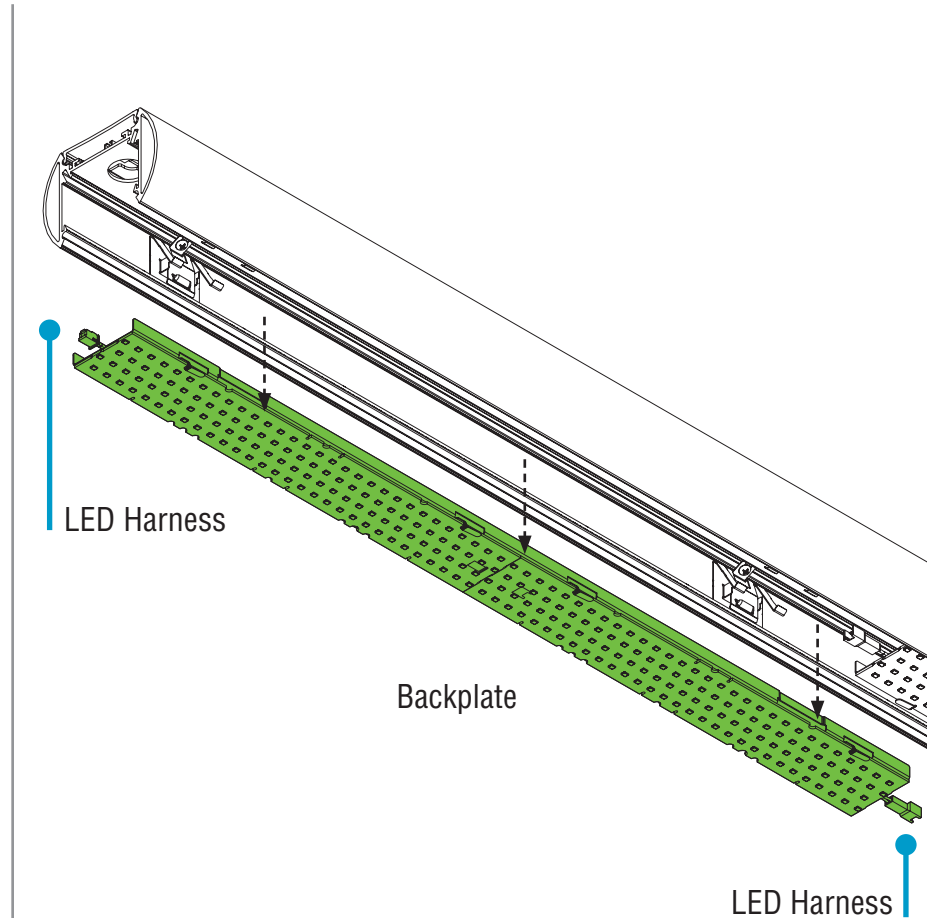

- Locate the backplate clip and use Putty Knife or Flat Head Screwdriver slide into either side of the clip
- Apply mild pressure to backplate when Putty Knife or Flat Head Screwdriver pushing into backplate clip release

- Hear a click sound to release the backplate
- Four backplate clip per LED backplate. Release all four before remove backplate

- Set aside backplates to prevent from getting dirty or damaged.
- Ensure backplates can be clearly identified back to their corresponding luminaire.

HPO Direct and Indirect/Direct (Flush or Round) Installation Instructions

Step 4 - Mounting Starter to Structure

A. Mount Starter to Structure Bottom-Up View

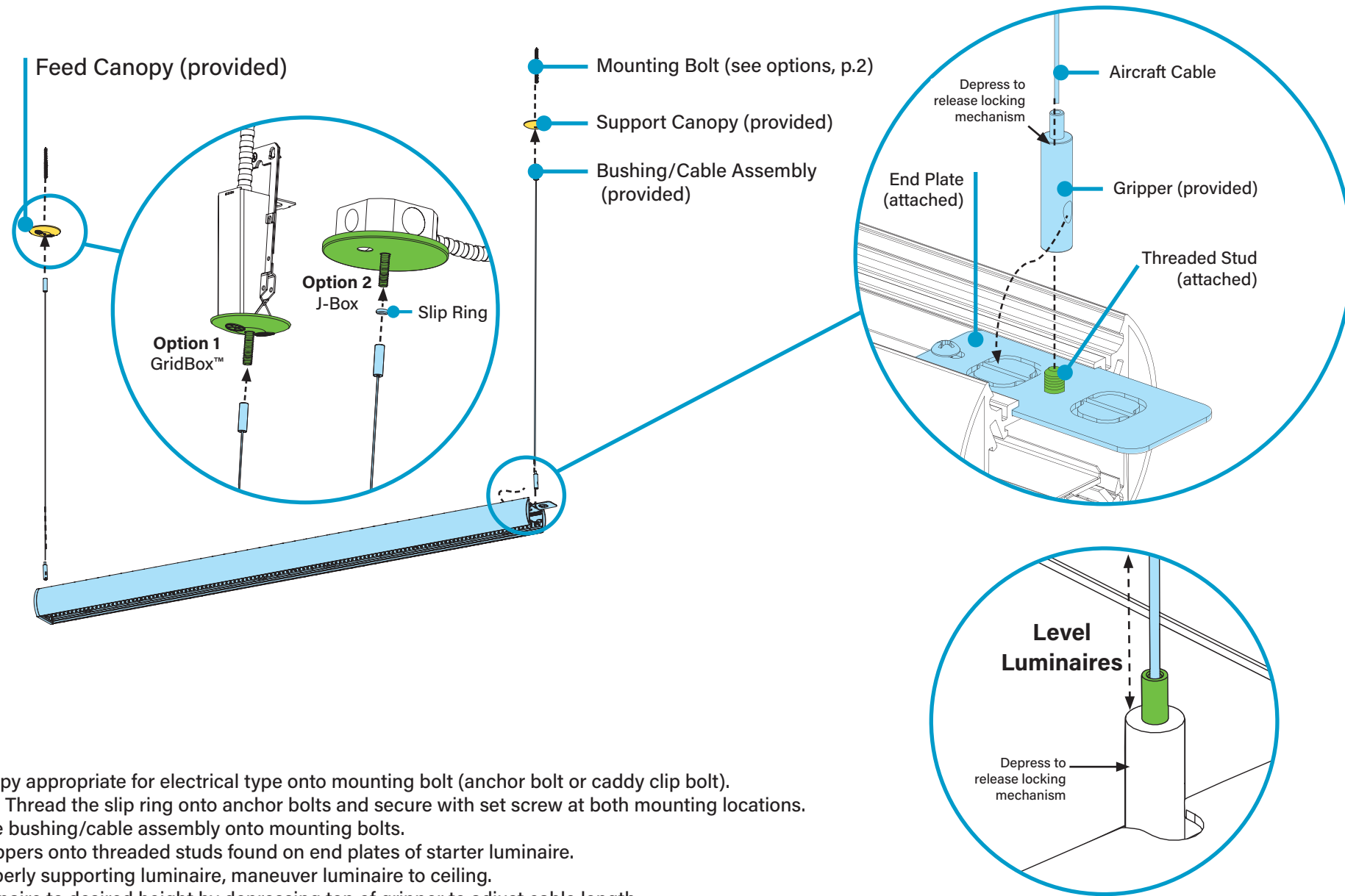

- Slide canopy appropriate for electrical type onto mounting bolt (anchor bolt or caddy clip bolt).
- **(Option 2)** Thread the slip ring onto anchor bolts and secure with set screw at both mounting locations.
- Thread the bushing/cable assembly onto mounting bolts.
- Attach grippers onto threaded studs found on end plates of starter luminaire.
- While properly supporting luminaire, maneuver luminaire to ceiling.
- Level luminaire to desired height by depressing top of gripper to adjust cable length.
- Feed the aircraft cable through and lead into the feed hole.

B. Make Electrical Connections Bottom-Up View

WIRING LEGEND		
Black	Hot	Line Voltage
White	Neutral	Line Voltage
Green	Ground	
Pink	Dimming	0-10V DC
Purple	Dimming	0-10V DC

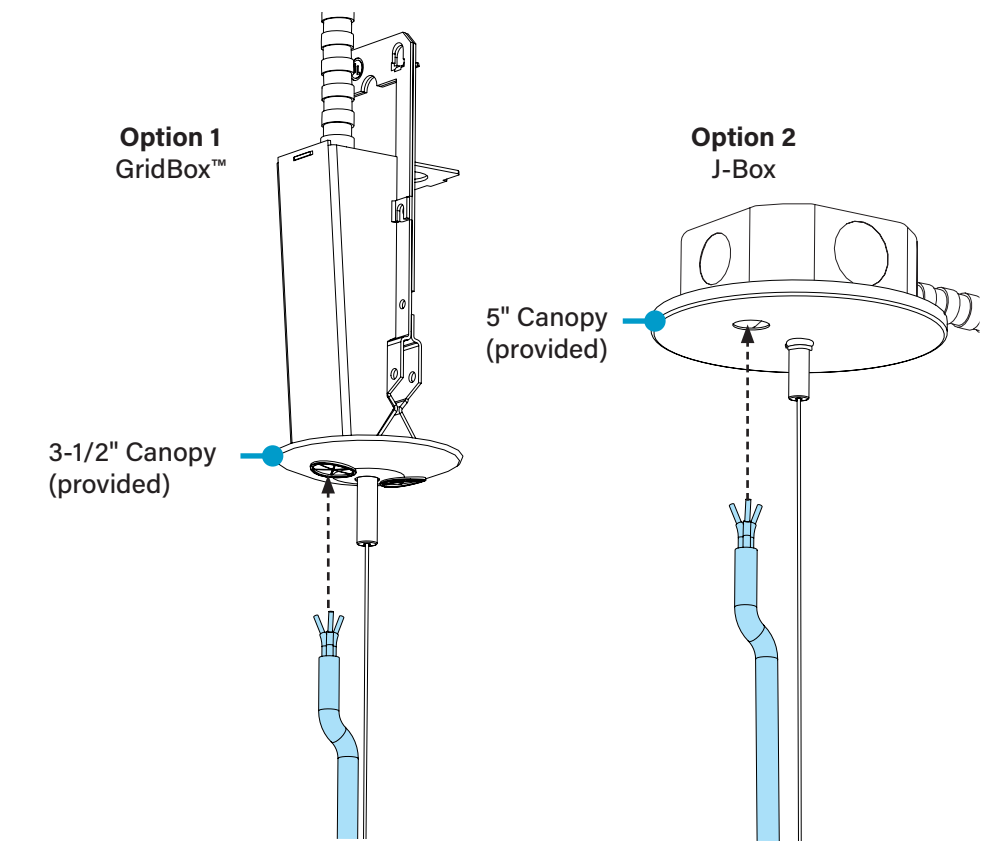

- **(Option 1)** Feed power cord through 3-1/2" canopy and connect wires inside GridBox™.
- **(Option 2)** Feed power cord through 5" canopy and connect wires inside J-Box.
- **CRITICAL: If installing an independent luminaire, perform all leveling. PROCEED TO STEP 7.**

Mounting Option 1 (shown)



Mounting Option 2

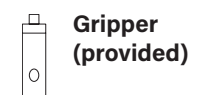
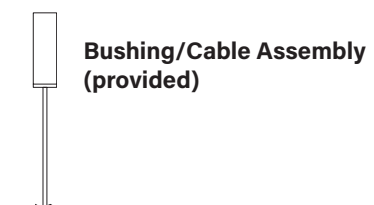

0-10V
Dimming

HPO Direct and Indirect/Direct (Flush or Round) Installation Instructions

Step 5 - Joining Luminaires

A. Mount Joiner/Ender to Structure Bottom-Up View

CAUTION **DO NOT** attempt to join luminaires together on the floor. Damage may result when lifted. Follow these instructions.

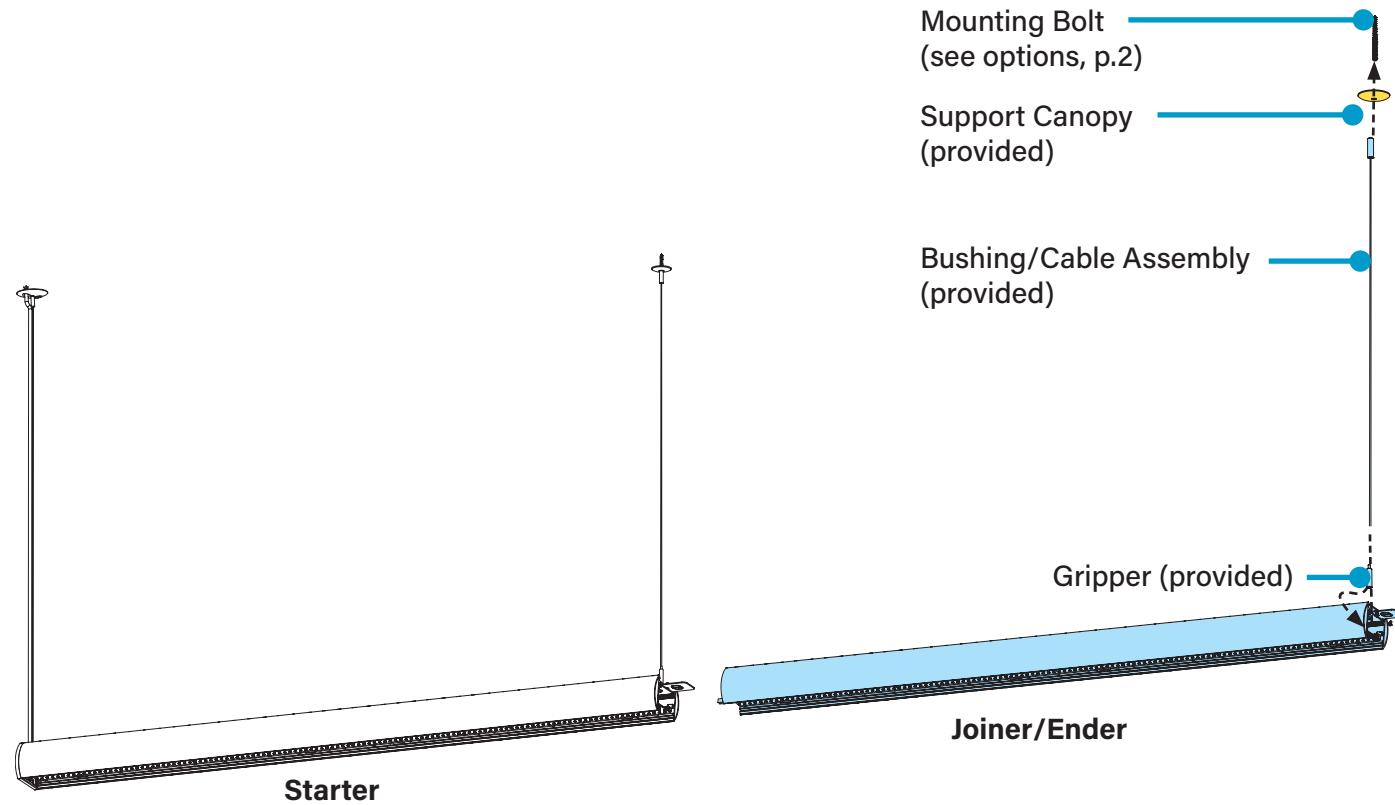

- For the joiner/ender luminaire, slide canopy appropriate for electrical type onto mounting bolt (anchor bolt or caddy clip bolt).
- Thread the bushing/cable assembly onto mounting bolt.
- Attach grippers onto threaded studs found on end plates of joiner/ender.
- While properly supporting luminaire, maneuver luminaire to ceiling.
- Depress the top of the gripper to feed the aircraft cable through and lead into the feed hole.

B. Join Luminaires Bottom-Up View

CAUTION Once luminaires are aligned together, **joiner luminaire is not yet secure**. Ensure it does not slide off as it rests on the starter luminaire.

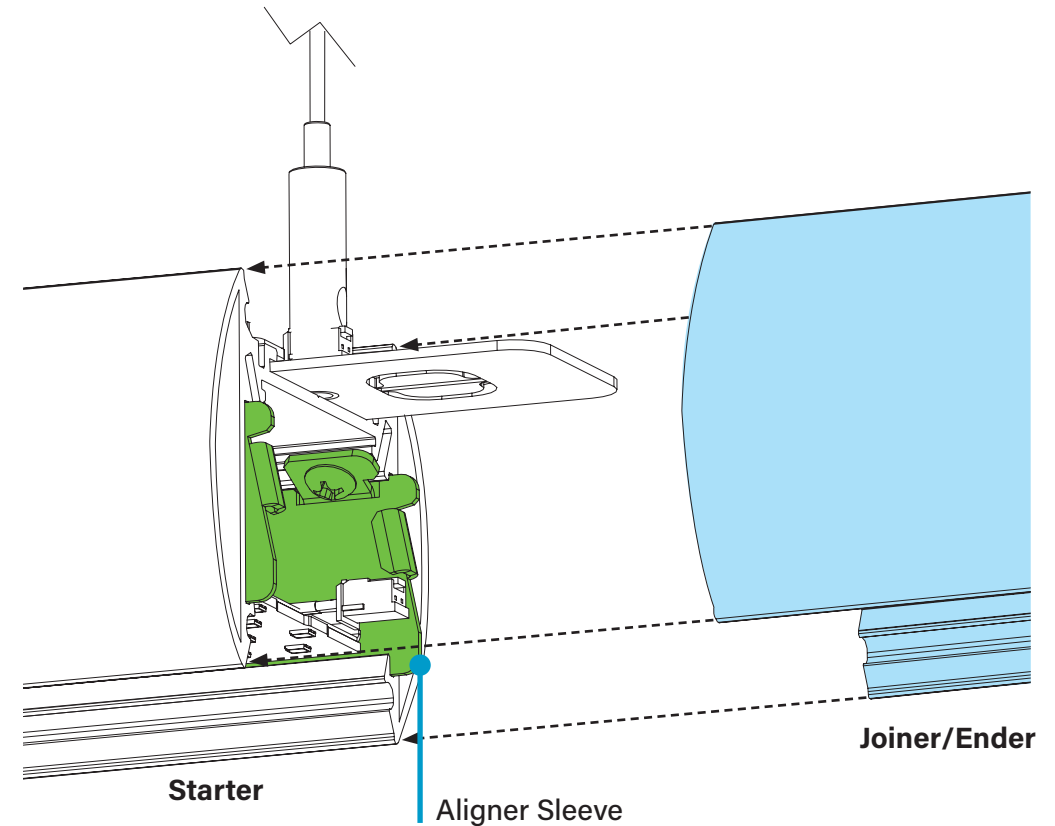

- Align joiner with aligner sleeves on starter and slide together. Be careful not to damage any wiring.
- If necessary, **lift** both luminaires, then slide together.

Mounting Option 1 (shown)



3-1/2" Canopy (provided)

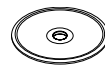

2" T-Bar Support Canopy (provided)

Mounting Option 2

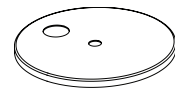

5" Canopy (provided)

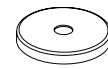

2" Drywall Support Canopy (provided)



Slip Ring w/ Set Screw (provided)



Bushing/Cable Assembly (provided)



Gripper (provided)



Robust Joint

HPO Direct and Indirect/Direct (Flush or Round) Installation Instructions

Step 6 - Securing Luminaire Joints

A. Secure Joint with Yoke Brackets Bottom-Up View

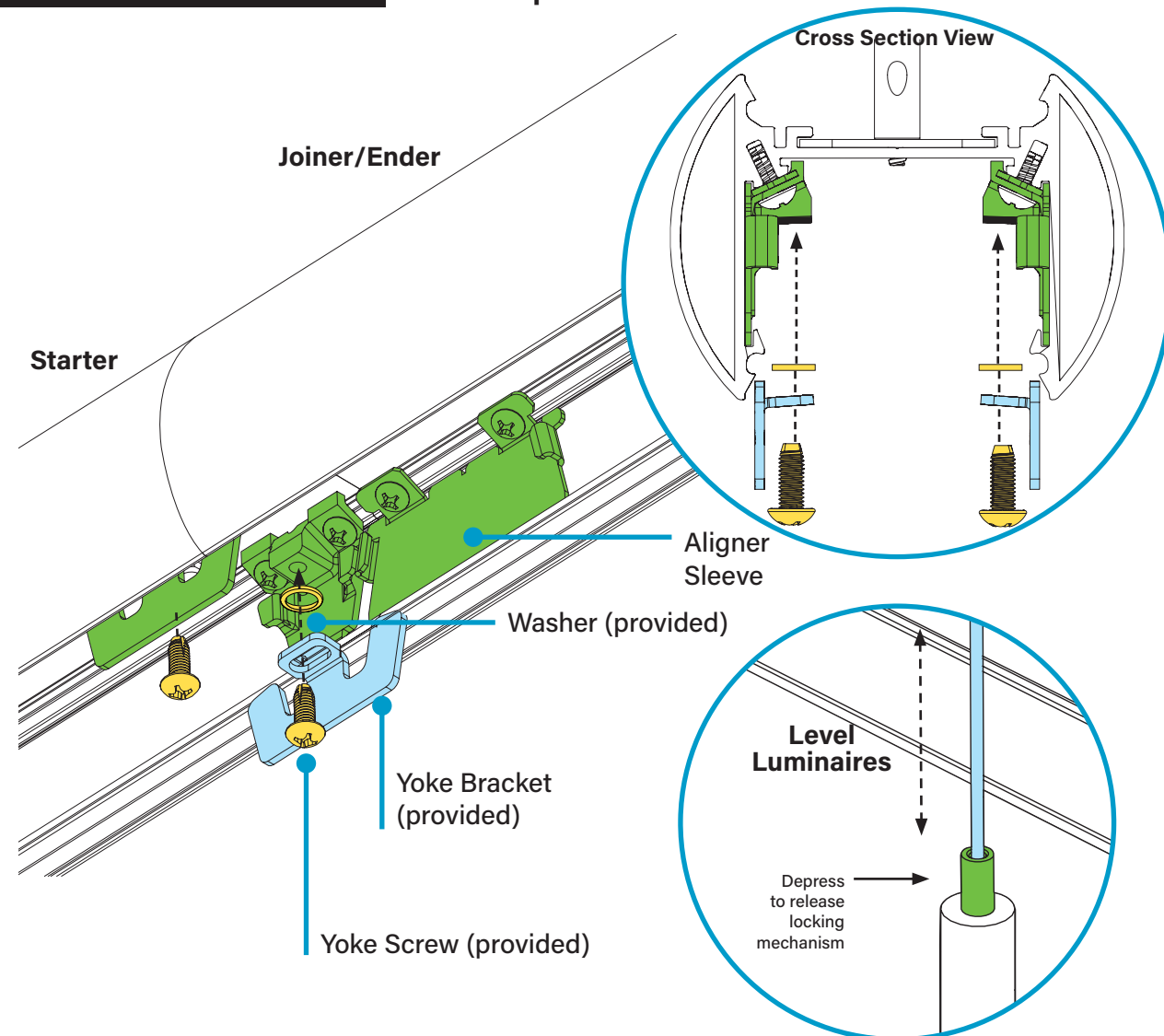

- Before installing yoke brackets, ensure the joining ends of luminaires meet flush and square.
- **CRITICAL:** Ensure yoke brackets properly engage with aligner sleeves.
- Secure joint by threading (but not yet tightening) yoke screws through yoke brackets and washers and into the aligner sleeves.
- Level each luminaire to desired height by depressing top of grippers to adjust cable lengths.
- **NOTE:** Ensure luminaires are level and meet flush and square before fully tightening yoke screws.
- Tighten yoke screws¹ until joint seam of luminaires is closed.

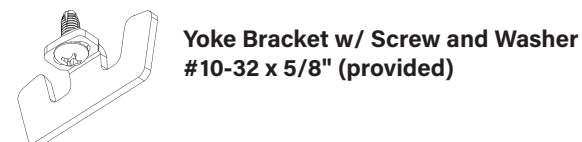

¹ Screwdriver with 6" bit required.

IN ALIGNMENT

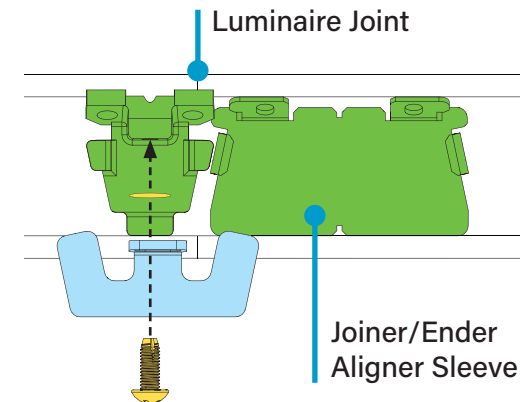

CORRECTLY INSTALLED

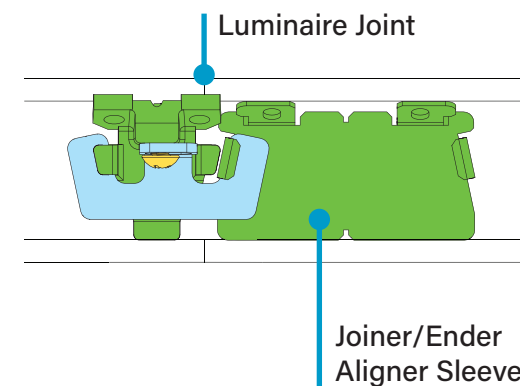

B. Make Electrical Connections Bottom-Up View

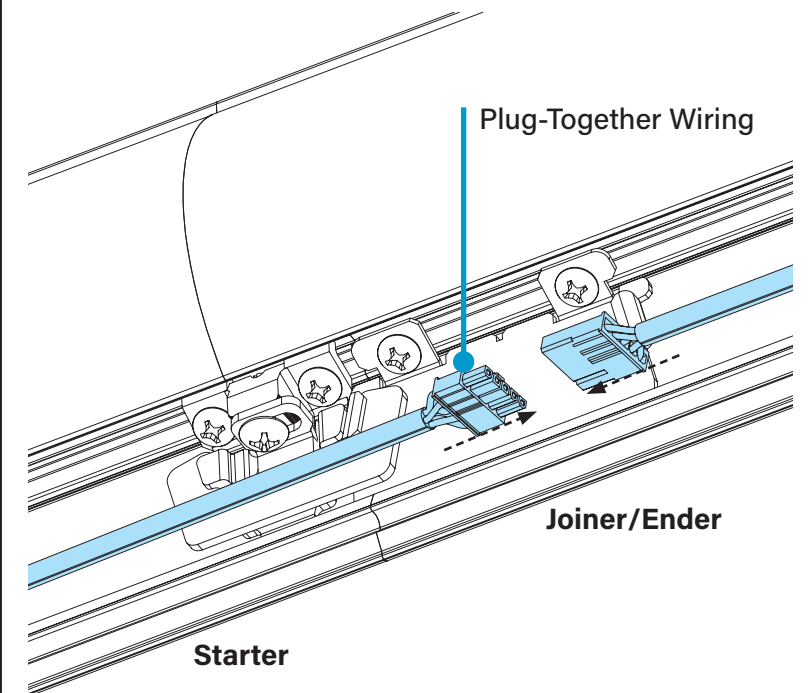

- Connect plug-together wiring.



Simple
Plug-Together
Wiring

HPO Direct and Indirect/Direct (Flush or Round) Installation Instructions

Step 7 - Closing Luminaires

A. Crimp Cables Bottom-Up View

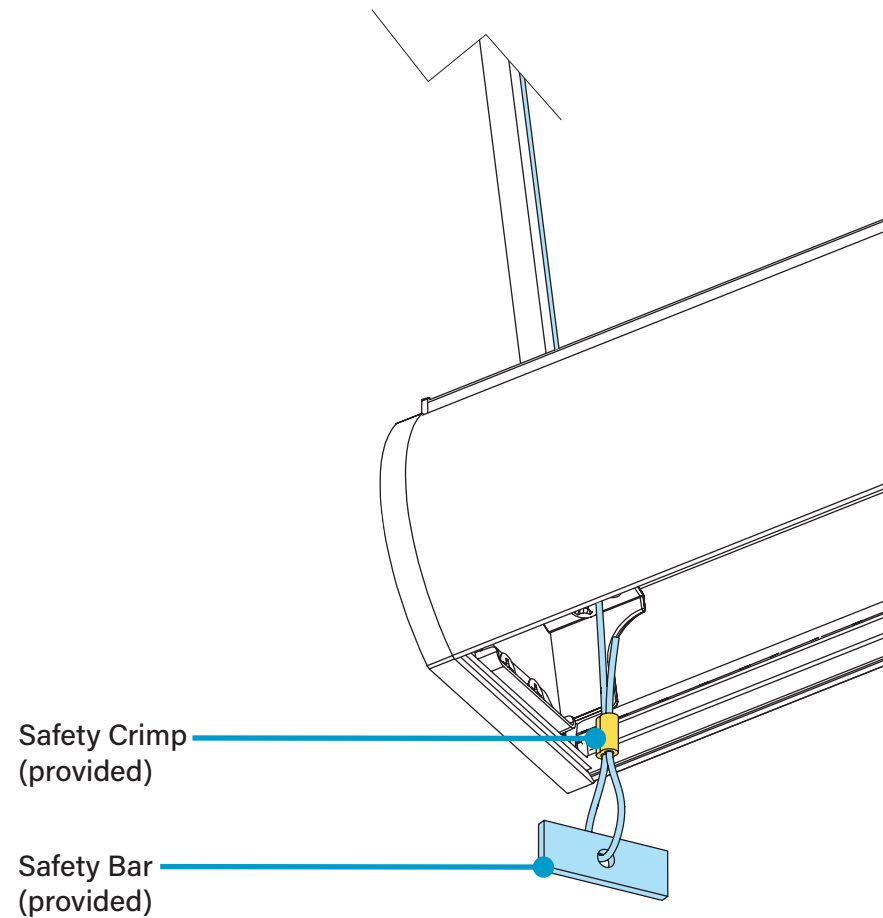

- If backplate is not already open at suspension point, then remove backplate first. **SEE STEP 3.**
- Run excess cable through feed hole.
- Loop cable through safety crimp and safety bar, then back through safety crimp.
- Crimp, then cut excess cable.
- Tuck safety loop inside luminaire.

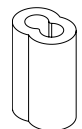

Safety Crimp
(provided)

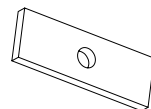

Safety Bar
(provided)

B. Final Step - Replace Backplates & Diffusers Bottom-Up View

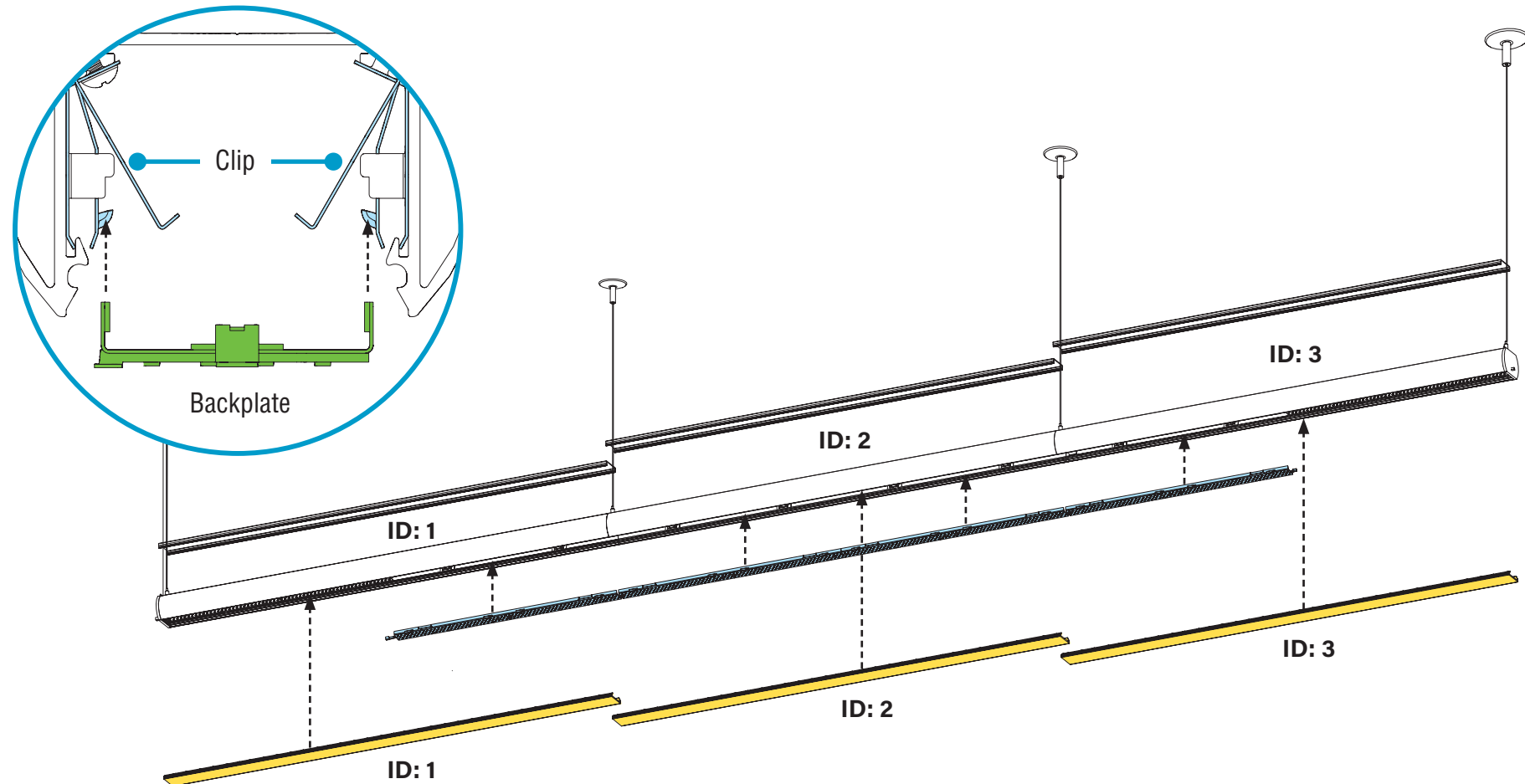

- **NOTE:** If your installation includes a battery backup, please see addendum (98333) that should be included with your kitting package.
- Reconnect LED harnesses.
- Reinstall backplates by inserting into luminaire body. Hear 4 clicks per LED backplate. Make sure ALL LED backplate secure before install diffusers.
- Remove diffusers from protective plastic bags.
- **CAUTION:** Wear gloves to keep diffuser surface clean.
- **CRITICAL:** Be sure to install correct diffuser to its corresponding luminaire ID.
- Install diffuser into luminaire body, ensuring it snaps into place.
- Turn power on to luminaires.