

HP-2 / HP-4 Indirect Installation Instructions

Overview

NOTES

- All power connections should be installed according to local/national codes by a Certified Electrician.
- This installation requires **proper support** as each luminaire is being installed.
- **DO NOT attempt to join luminaires together on the floor.** Damage may result when lifted.



HELPFUL
VIDEOS



0-10V
Dimming



Universal &
Robust Joints



Simple
Plug-Together
Wiring

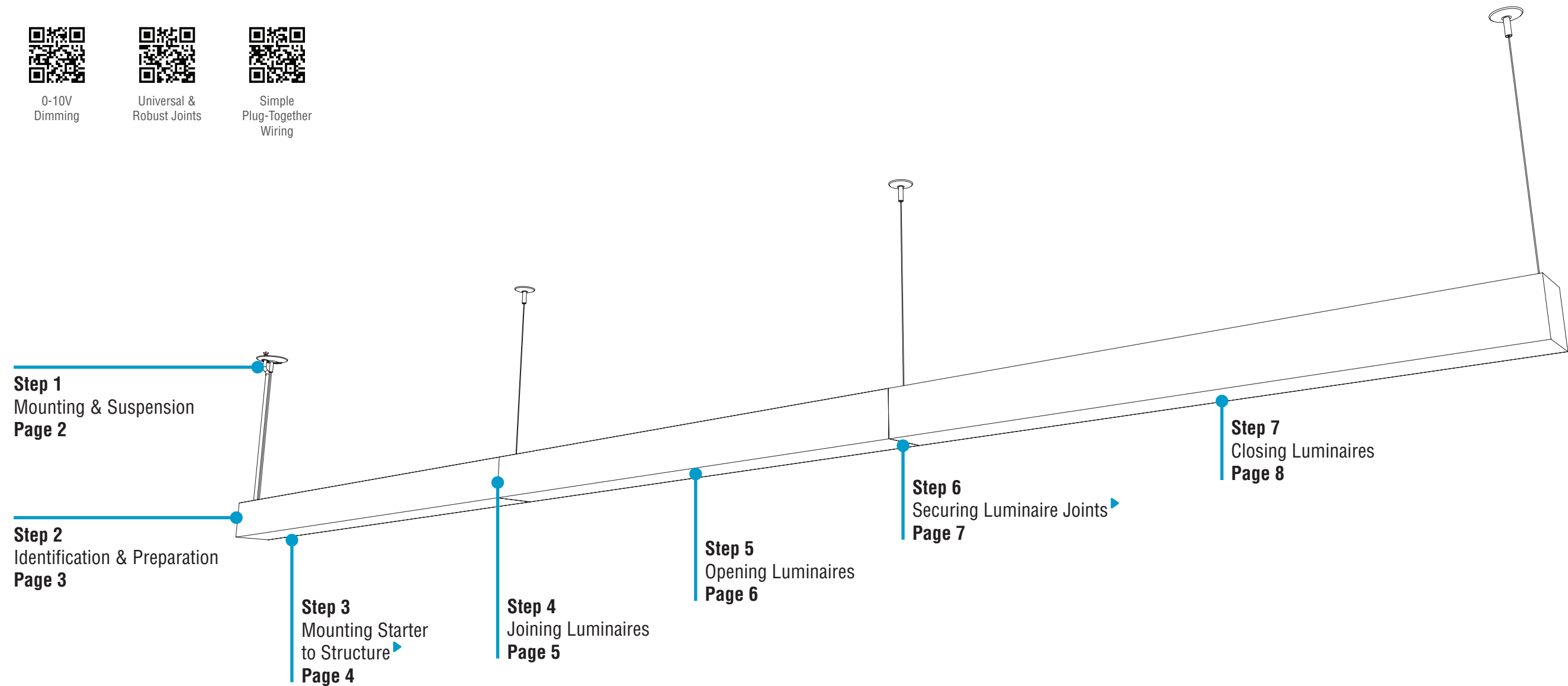

Step 1
Mounting & Suspension
Page 2

Step 2
Identification & Preparation
Page 3

Step 3
Mounting Starter
to Structure
Page 4

Step 4
Joining Luminaires
Page 5

Step 5
Opening Luminaires
Page 6

Step 6
Securing Luminaire Joints
Page 7

Step 7
Closing Luminaires
Page 8

HP-2 / HP-4 Indirect Installation Instructions

Step 1 - Mounting & Suspension

Mounting Options

Option 1 T-Bar Mounting - GridBox™, Caddy Clips

- Install GridBox™ and electrical conduit at feed locations.
- Install caddy clips at mounting point locations.
- All caddy clips are to be secured to structure, per local building codes.

Option 2 Drywall (C4) or other hard surfaces* - J-Box, Anchor Bolts

- Install J-Box and electrical conduit at feed locations.
- Install anchor bolts at mounting point locations.
- All anchor bolts are to be secured to structure, per local building codes.

* Other hard surfaces include: wood, sheet metal panels, steel beams, concrete or masonry. Use hardware appropriate for each surface material type.

Suspension Locations

X = Suspension Dimensions

Refer to Record Drawings and building plans to determine exact mounting, suspension points, and power feed locations.

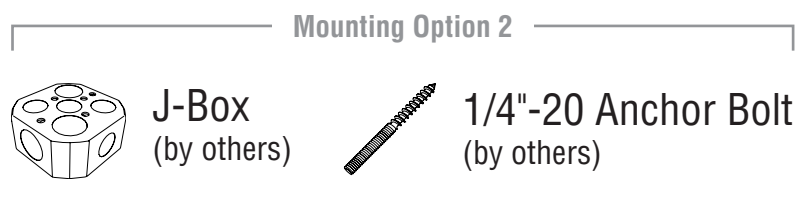
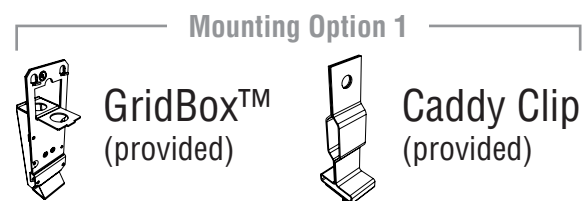
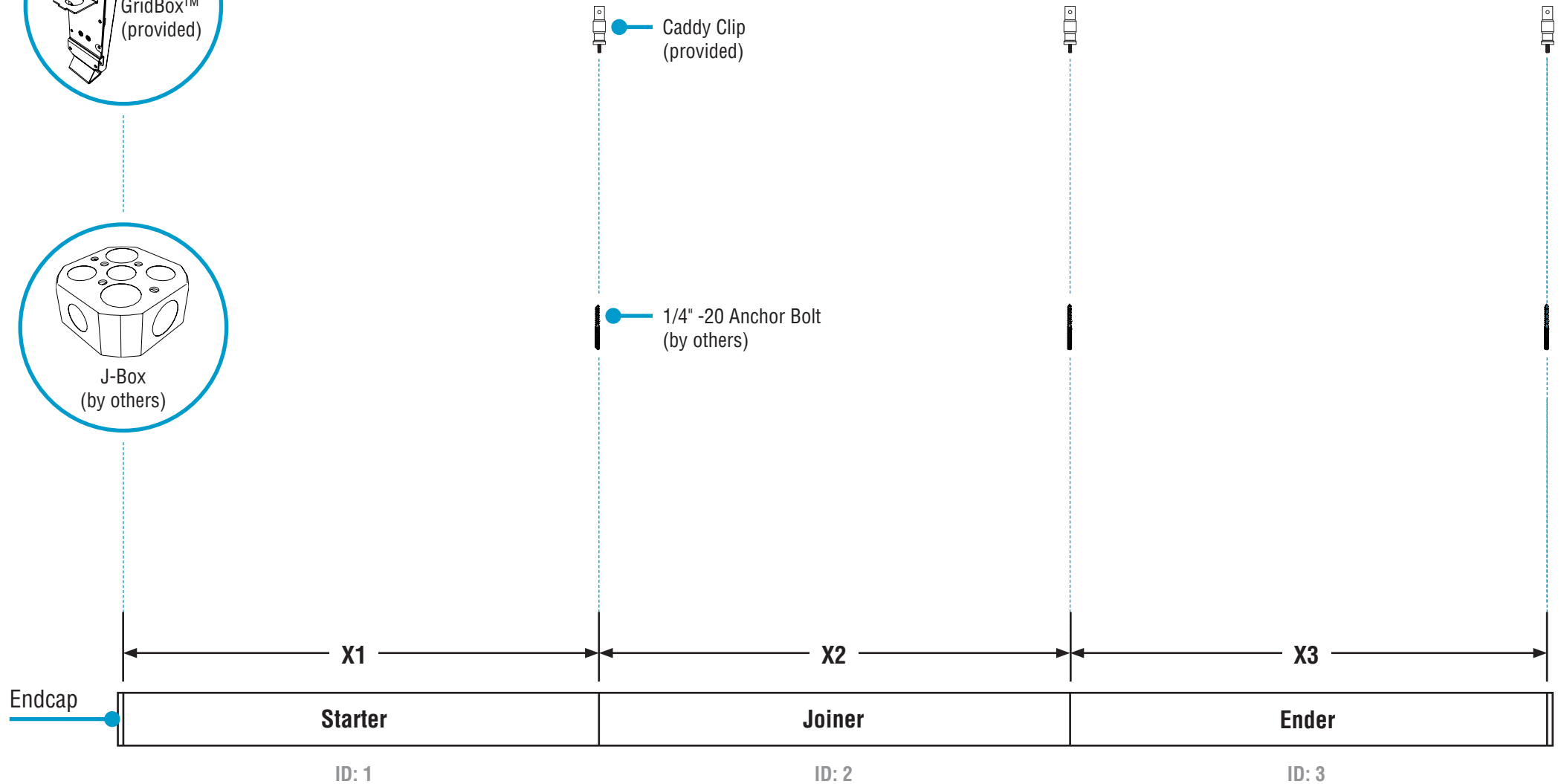
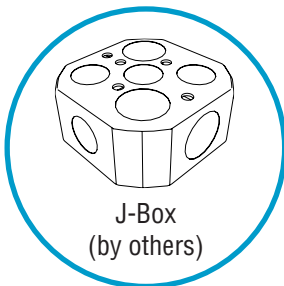
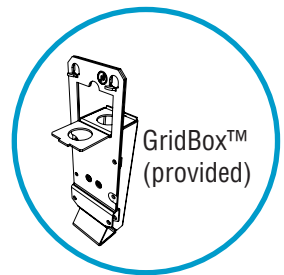

HP-2 / HP-4 Indirect Installation Instructions

Step 2 - Identification & Preparation

A. Identify Luminaires



CAUTION

Arrange luminaires in order according to ID# at their install locations.

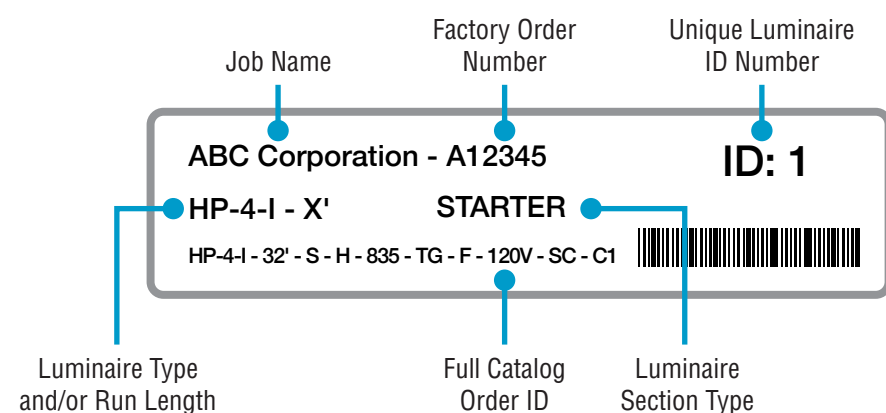

- Identify all luminaires by their ID label that can be found on the box, the diffuser, and inside the luminaire.
- NOTE:** Exact location of labels in these areas may vary.
- Remove all luminaires from their box.
- Refer to Record Drawings that can be found in the hardware kit.

B. Remove Diffusers

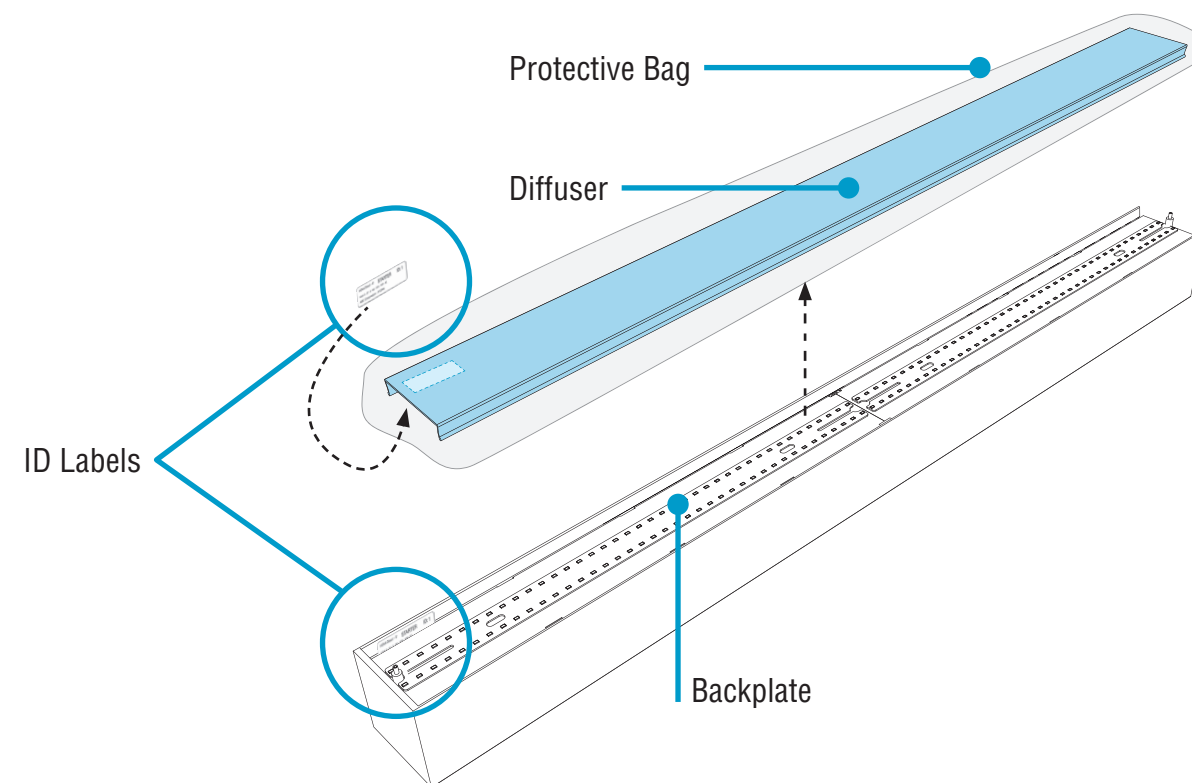

- Carefully remove all diffusers keeping them inside their protective bags.
- Set aside all diffuser to prevent from getting dirty or damaged.
- Ensure diffusers can be clearly identified back to its corresponding luminaire.

Kitted Hardware

- Finelite has provided items listed here, with their Finelite part numbers. These items can be found in separate boxes shipped with the luminaire.
- Account for all parts and set aside until they are needed.
- All other hardware needed for this installation will be by others.

Mounting Option 1

GridBox™ Part# 89159	3-1/2" Canopy Part# 89191
Dual GridBox™ Part# 89199 Mounting & Suspension p. 2, Step 1	3-1/2" Dual Feed Canopy Part# 89192 Mounting Starter to Structure p. 4, Step 3 Joining Luminaires p. 5, Step 4
Caddy Clip C1 Ceiling - Part# 94001 C2 Ceiling - Part# 94020 C3 Ceiling - Part# 94029 Mounting & Suspension p. 2, Step 1	2" Support Canopy (T-Bar) Part# 89193 Mounting Starter to Structure p. 4, Step 3 Joining Luminaires p. 5, Step 4

Mounting Option 2

5" Canopy Part# 94085
5" Dual Feed Canopy Part# 94145 Mounting Starter to Structure p. 4, Step 3 Joining Luminaires p. 5, Step 4
2" Support Canopy (Drywall) Part# 94017 Mounting Starter to Structure p. 4, Step 3 Joining Luminaires p. 5, Step 4

Cable Bushing
Part# 94014

Aircraft Cable
50" - Part# 94515-12 (Std.)
100" - Part# 94515-14
150" - Part# 94515-18
Mounting Starter to Structure
p. 4, Step 3
Joining Luminaires
p. 5, Step 4

 Yoke Bracket
Part# 45042

#10-32 x 5/8" Screw
Part# 94144
Securing Luminaire Joints
p. 7, Step 6

 Safety Crimp
Part# 94514
Closing Luminaires
p. 8, Step 7

 Slip Ring w/Set Screw
Part# 94015
Mounting Starter to Structure
p. 4, Step 3
Joining Luminaires
p. 5, Step 4

HP-2 / HP-4 Indirect Installation Instructions

Step 3 - Mounting Starter to Structure

Mount Starter to Structure

WIRING LEGEND		
Black	Hot	Line Voltage
White	Neutral	Line Voltage
Green	Ground	
Pink	Dimming	0-10V DC
Purple	Dimming	0-10V DC

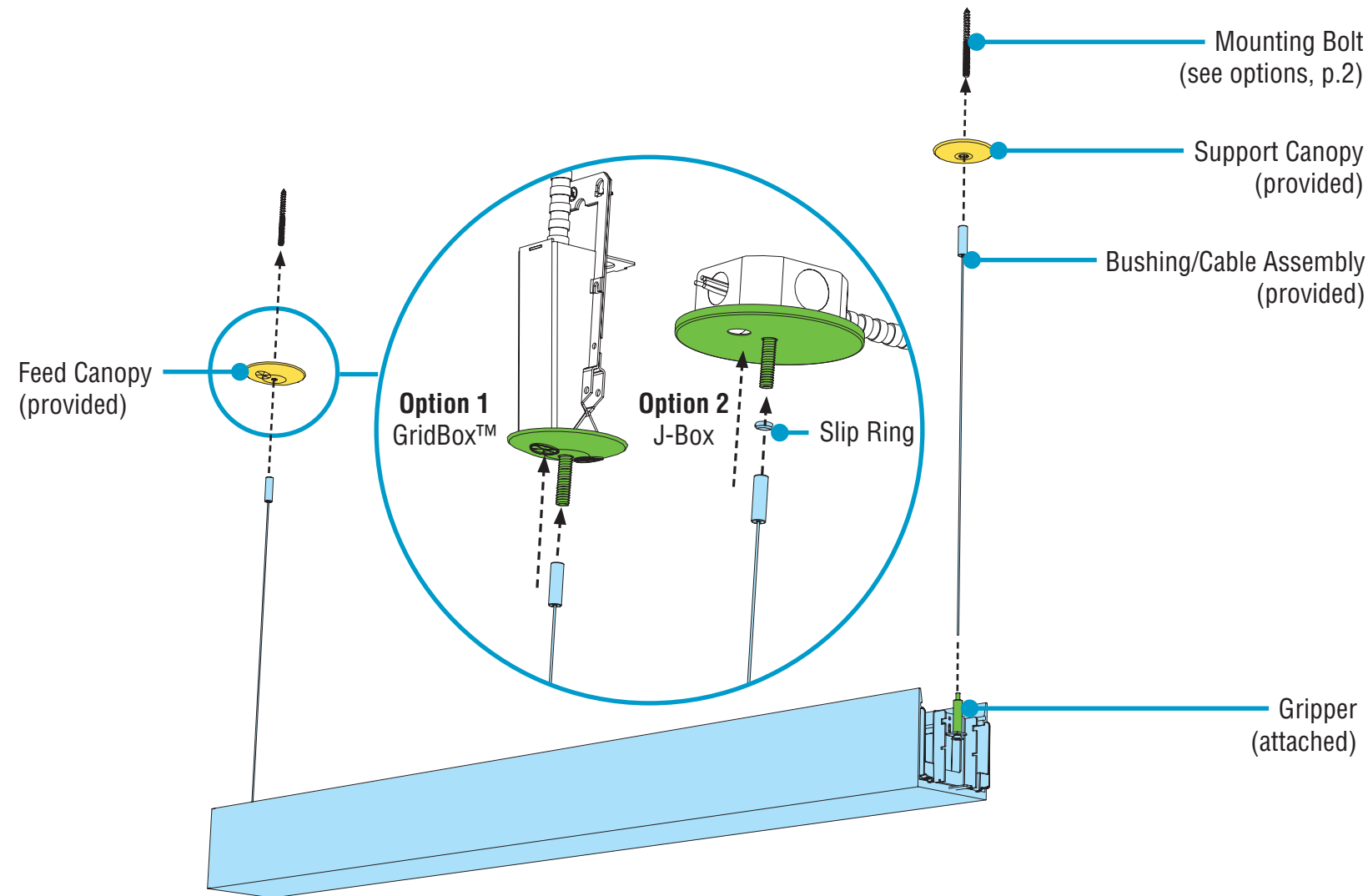

Mounting Option 1 - T-Bar Mounting, GridBox™ with 3-1/2" Canopy (shown)

- Slide canopy onto caddy clip bolt and thread the bushing/cable assembly onto caddy clip bolt at both mounting locations.
- While properly supporting luminaire, maneuver luminaire to ceiling.
- Feed power cord through canopy knockout and connect wires inside GridBox™.
- Locate grippers at luminaire ends and feed end of aircraft cable through it by depressing top of gripper.
- **CRITICAL:** If part of an independent run, perform all leveling. **PROCEED TO STEP 5.**

Mounting Option 2 - Drywall, J-Box with 5" Feed Canopy

- Slide canopy onto anchor bolt and thread the slip ring onto anchor bolt. Secure with set screw.
- Thread the bushing/cable assembly onto anchor bolt at both mounting locations.
- While properly supporting luminaire, maneuver luminaire to ceiling.
- Feed power cord through canopy knockout and connect wires inside J-Box.
- Locate grippers at luminaire ends and feed end of aircraft cable through it by depressing top of gripper.
- **CRITICAL:** If part of an independent run, perform all leveling. **PROCEED TO STEP 5.**

Mounting Option 1 (shown)



Mounting Option 2

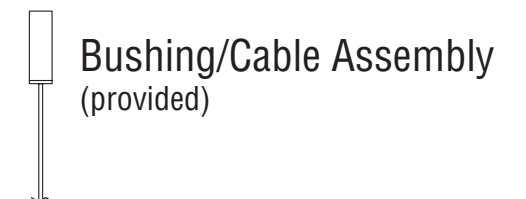

0-10V Dimming

HP-2 / HP-4 Indirect Installation Instructions

Step 4 - Joining Luminaires

A. Mount Joiner/Ender to Structure



CAUTION

DO NOT attempt to join luminaires together on the floor. Damage may result when lifted. Follow these instructions.

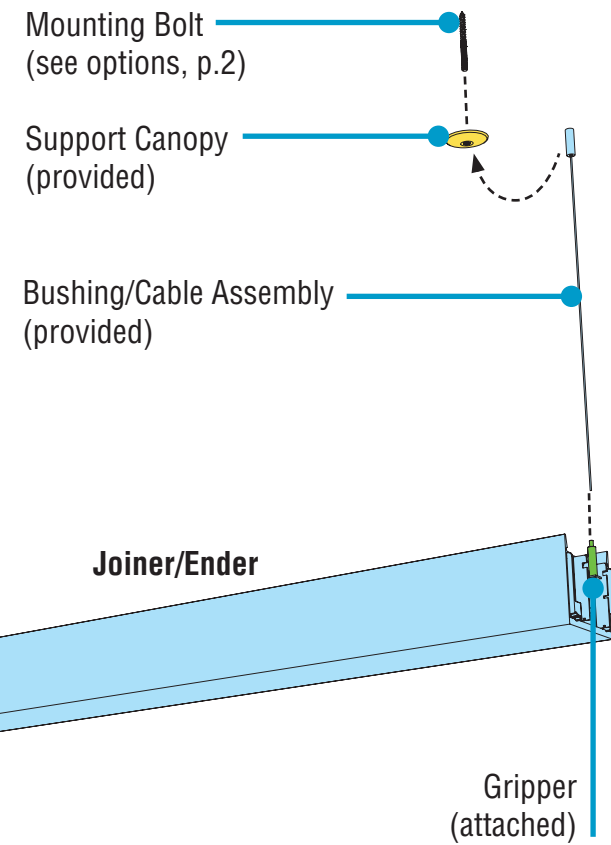

- For the joiner/ender luminaire, slide canopy appropriate for electrical type onto mounting bolt (anchor bolt or caddy clip bolt).
- Thread the bushing/cable assembly onto mounting bolt.
- While properly supporting luminaire, maneuver luminaire to ceiling.
- Locate gripper at luminaire ends and feed aircraft cable through it by depressing top of gripper.

B. Join Luminaires



CAUTION

Once luminaires are aligned together, **joiner luminaire is not yet secure.** Ensure it does not slide off as it rests on the starter luminaire.

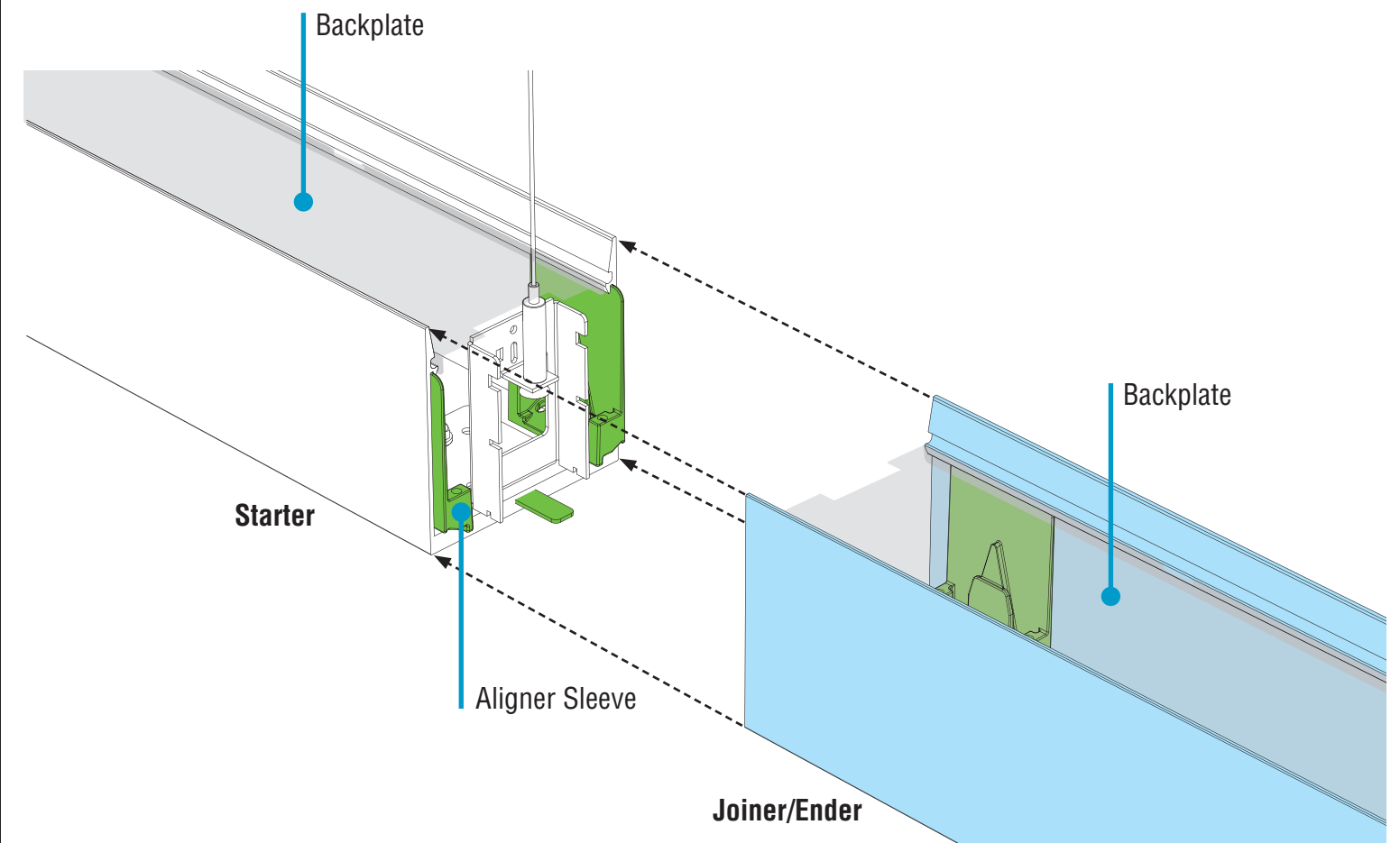

- Align joiner/ender with aligner sleeves on starter and slide together. Be careful not to damage any wiring.
- If necessary, **lift** both luminaires, then slide together.

Mounting Option 1 (shown)



3-1/2" Canopy (provided)

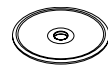

2" Support Canopy (T-Bar, provided)

Mounting Option 2

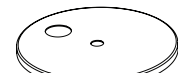

5" Canopy (provided)

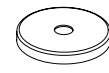

2" Support Canopy (Drywall, provided)



Slip Ring w/Set Screw (provided)



Bushing/Cable Assembly (provided)

HP-2 / HP-4 Indirect Installation Instructions

Step 5 - Opening Luminaire

Release Backplates

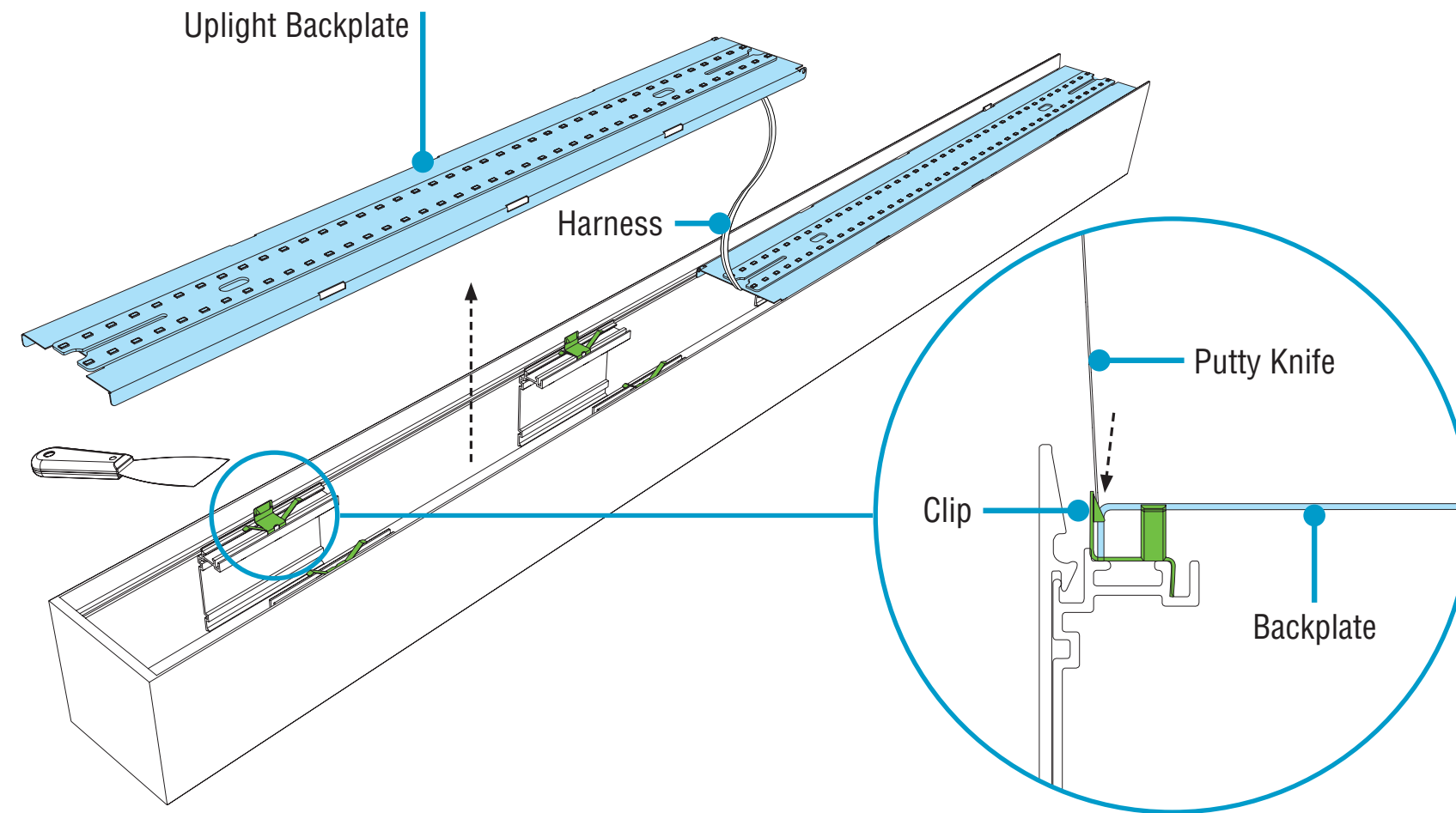

- To release backplates **at joints only**, use a putty knife to slip behind backplate edges and release them from clips.
- Lift backplate out of housing channel, pulling wiring harnesses through the housing.
- Let backplate rest atop of luminaire. **DO NOT** disconnect LED board harnesses.
- **NOTE:** If part of an independent section, **PROCEED TO STEP 7.**

HP-2 / HP-4 Indirect Installation Instructions

Step 6 - Securing Luminaire Joints

A. Secure Joint with Yoke Brackets

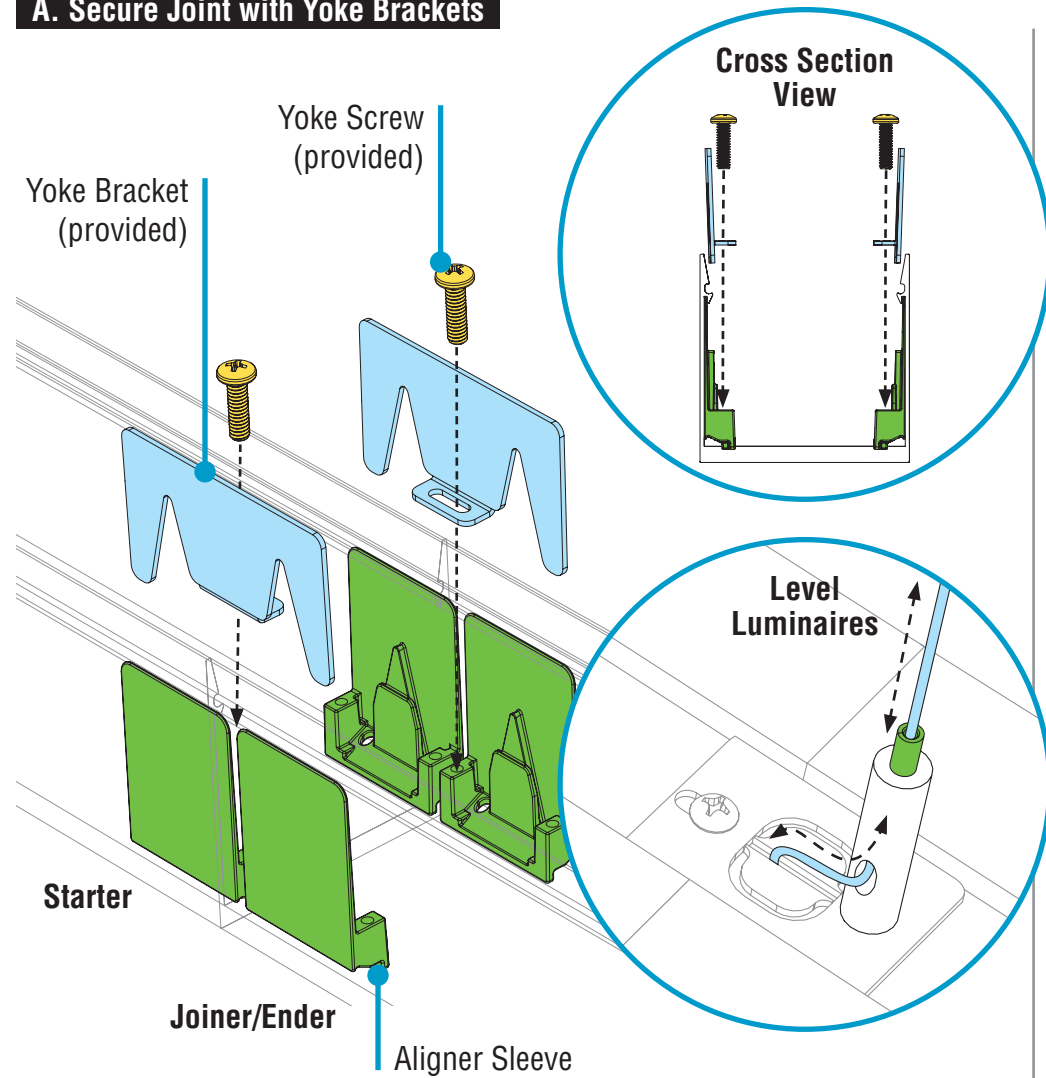

- Before installing yoke brackets, ensure the joining ends of luminaires meet flush and square.
- **CRITICAL:** Ensure yoke brackets properly engage with aligner sleeves.
- Secure joint by threading (but not yet tightening) yoke screws through yoke brackets and into the aligner sleeves.
- Level all luminaires to desired height by depressing top of grippers to adjust cable lengths.
- Tighten yoke screws¹ until joint seam of luminaires is closed.

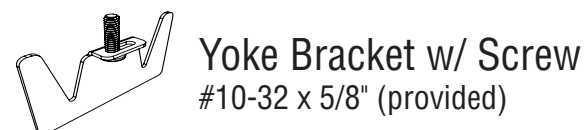

¹ Screwdriver with 6" bit required.

IN ALIGNMENT

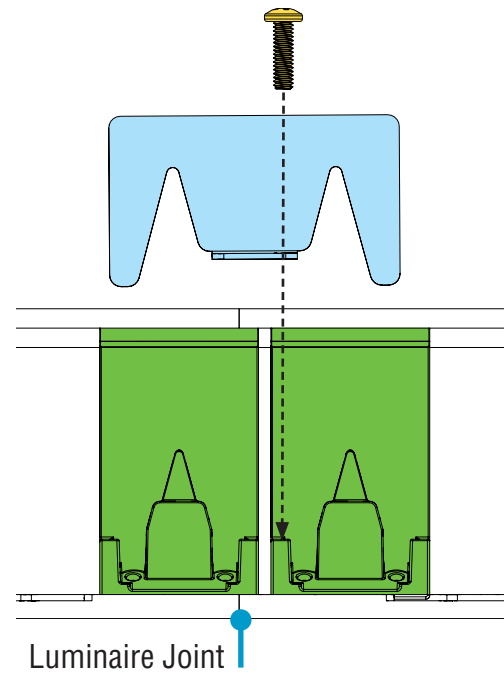

YOKE SCREW ALIGNMENT Bottom-Up View

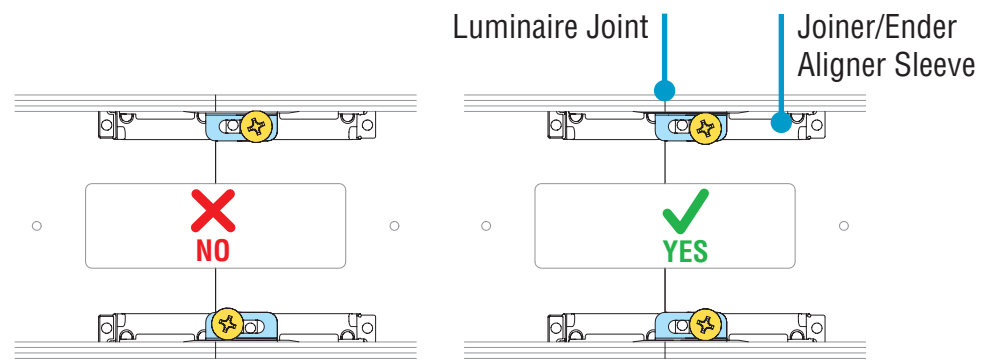

NOTE: Yoke screws should be installed directly across from each other, not diagonally, and in holes furthest from the joint line. One yoke screw per one yoke bracket.

CORRECTLY INSTALLED

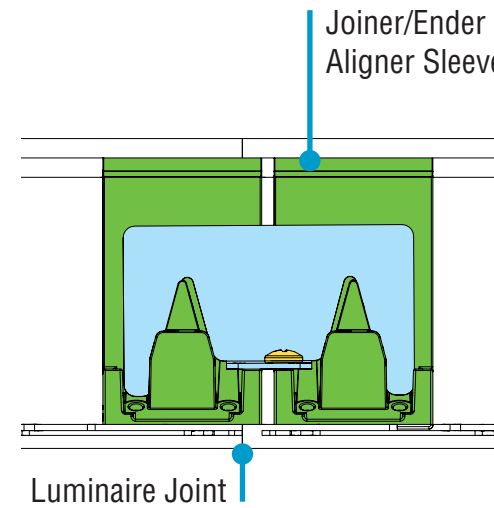

B. Make Electrical Connections

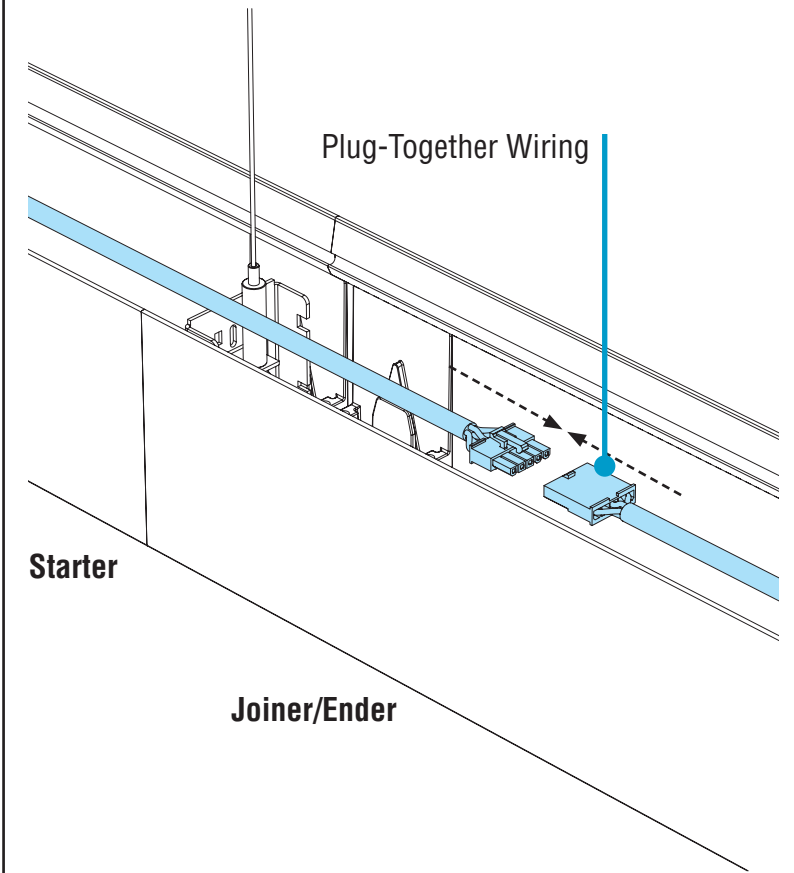

- Connect plug-together wiring.



Universal & Robust Joints



Simple Plug-Together Wiring

HP-2 / HP-4 Indirect Installation Instructions

Step 7 - Closing Luminaires

A. Crimp Cables

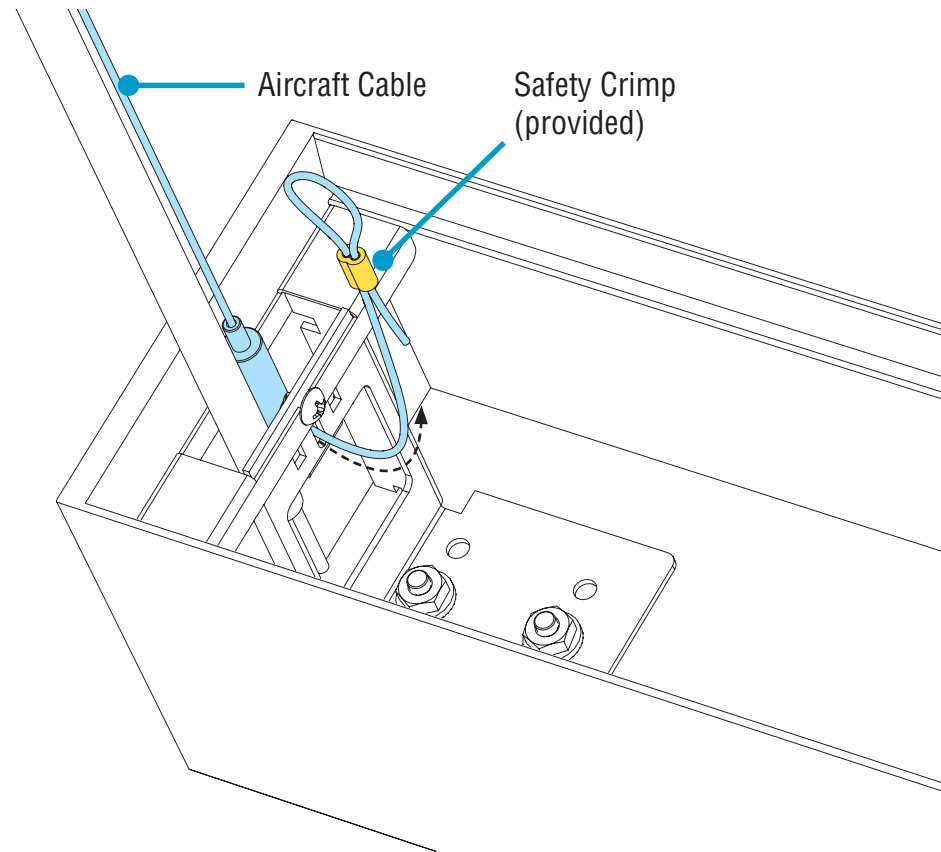

- Feed end of aircraft cable into luminaire body as shown.
- Loop aircraft cable through safety crimp.
- Crimp, cut excess cable and tuck into luminaire body. Typical for each aircraft cable.



B. Final Step - Replace Backplates & Diffusers

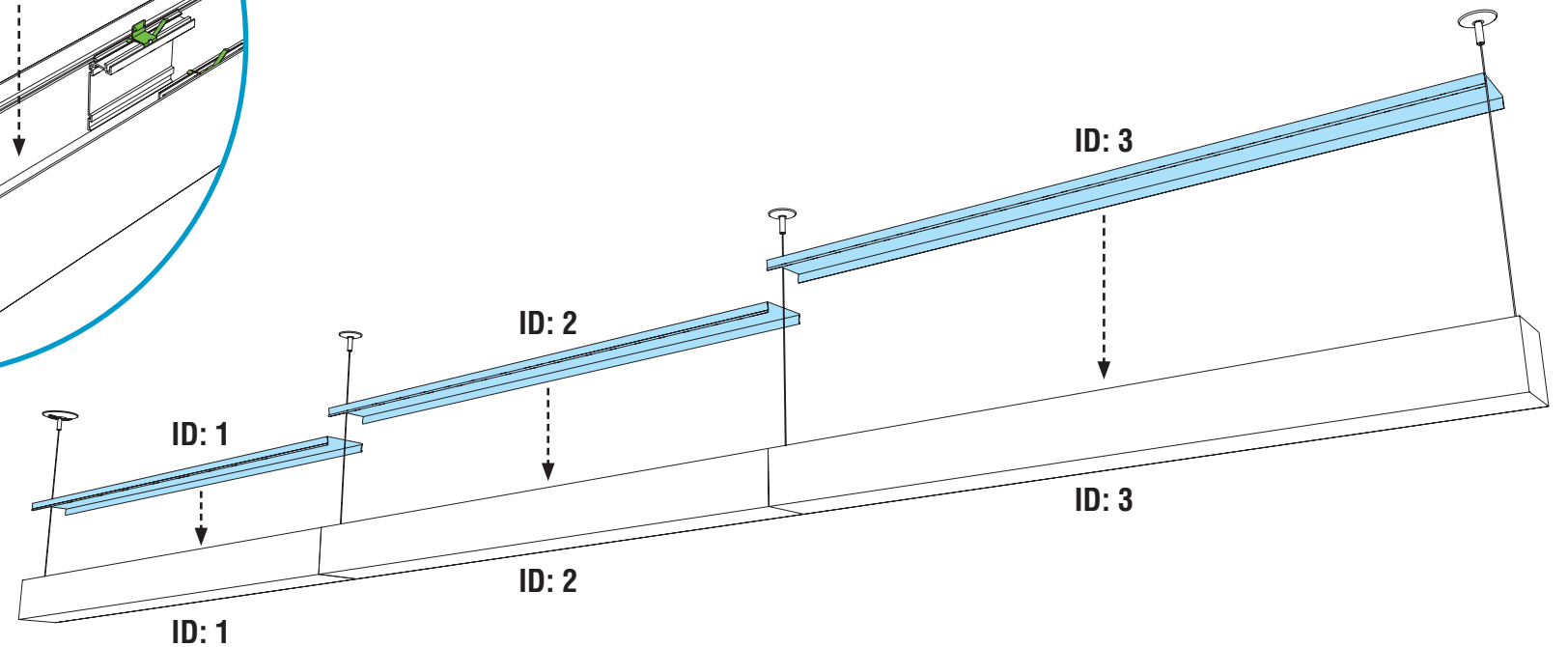
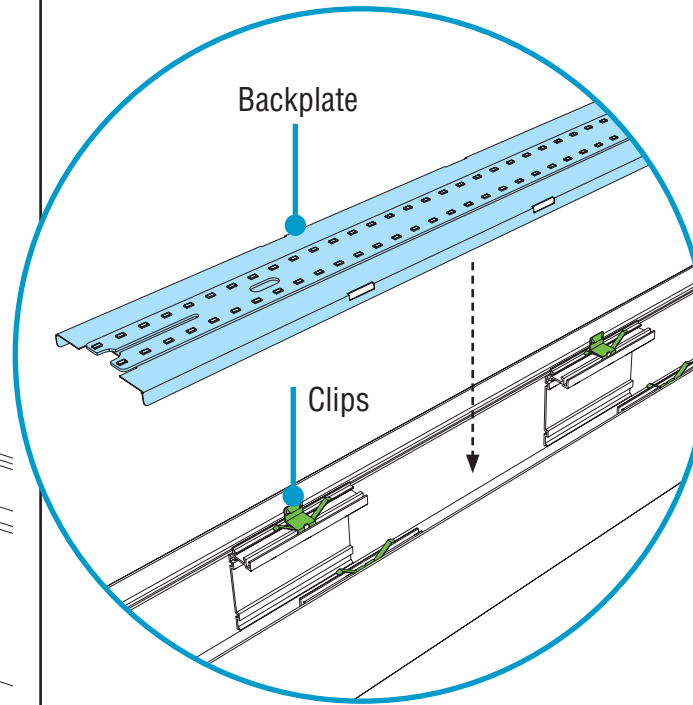

- **NOTE:** If your installation includes a battery backup, please see addendum (98333) that should be included with your kitting package.
- Reinstall all upright backplates by placing back into upright channel and snapping into clips.
- Remove diffusers from protective plastic bag.
- **CAUTION:** Wear gloves to keep diffuser surface clean.
- **CRITICAL:** Be sure to install correct diffusers to its corresponding luminaire ID.
- Install upright diffusers by snapping into place.
- Turn power on to luminaire.