

HPT

A sophisticated luminaire family that delivers outstanding performance up to 149 lumens per Watt with maximum visual comfort. The HPT modern design features a 1-1/2" regressed diffuser that creates a seamless, elegant transition from ceiling plane to luminaire and reveals a distinguished skylight aesthetic. Availability of 2'x2', 3'x3', & 4'x4' sizes provides designers the capability to match building scale and bring heightened visual interest to a space by combining different sizes.

This product is enrolled in the International Living Future Institute (ILFI) Declare 2.0 Program and is third-party verified.

Declare.



Easy Installation

Integral pry-out tabs provide simple and secure installation to ceiling grid.

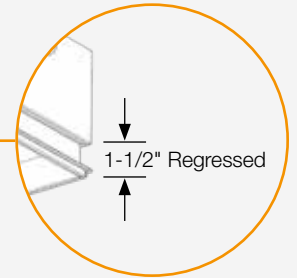
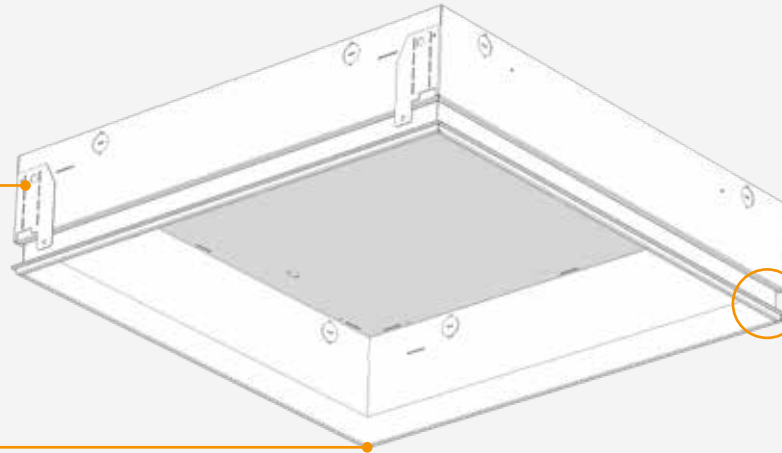

Detailed Construction

Seamless corner joints allow the 1-1/2" regressed diffuser to showcase the beauty of the luminaire from below the ceiling.



Cool Running LED Driver

Extends the driver lifetime combined with mid-powered LEDs.

Visual Comfort

Evenly distributed mid-power LEDs for a soft skylight effect.

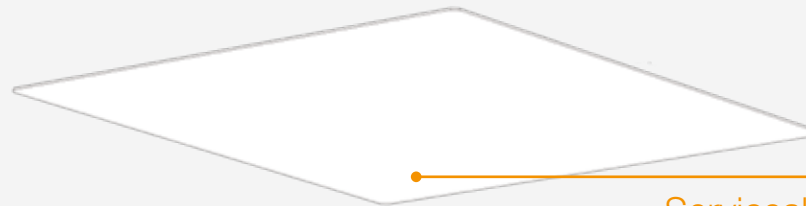
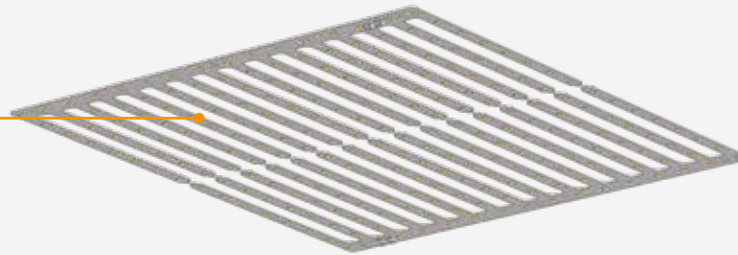

Serviceable From Below

A lift and shift diffuser provides fast access to light engines for easy servicing.



2'x2' shown, also available in 3'x3' & 4'x4' sizes
(LED board design differs on 3'x3' and 4'x4' sizes)



2700K



3500K



6500K

Tunable White option enhances the skylight aesthetic provided by the 1-1/2" regressed diffuser.

Tailored Output

- Four lumen packages available: Standard (**S**), Boosted Standard (**B**), High (**H**), and Very High (**V**).

Tailored Control

- Dimming from 100% to 10% standard, 1% available.
- Simplified white light color tuning design

Tailored Color

- Static White options: 3000K, 3500K, 4000K CCT.
- Tunable White options: 2700K – 6500K CCT.

Available Sizes

- 2'x2'¹
- 3'x3'
- 4'x4'

¹ 2'x2' also available with Surface Mount & Pendant Mount options



Open Office

Application Data

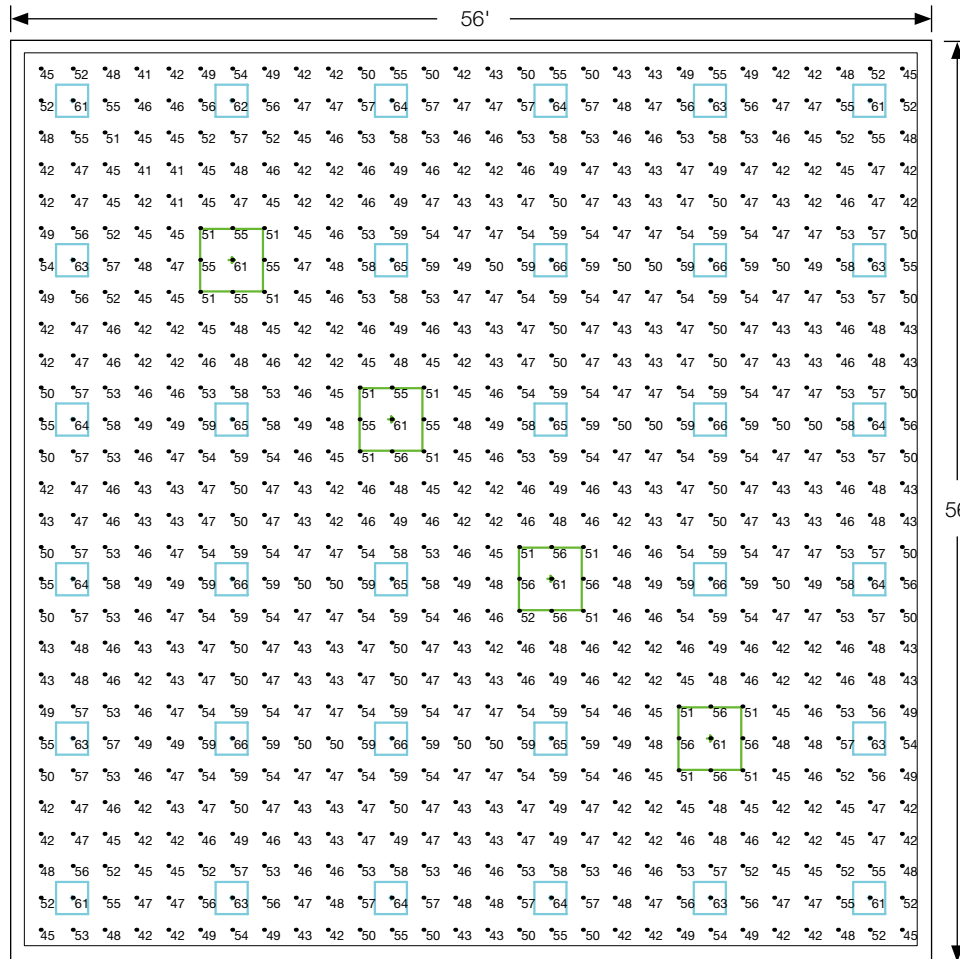

■ HPT 2'x2'
■ HPT 4'x4'

HPT-RSE-2x2-B-835 HPT-RSE-4x4-B-835-40Dim	
Average Light Level on Desktop (Footcandles)	50
Average to Minimum on Desktop (Illuminance)	1.2:1
Energy Consumption (Lighting Power Density)	0.44 W/ft ²
Room Size (Area)	56' x 56'

- Ceiling Height: 9'0"
- Room Reflectances: 80/50/20
- Luminaires are recessed into ceiling
- Light levels are initial

Concourse

Application Data

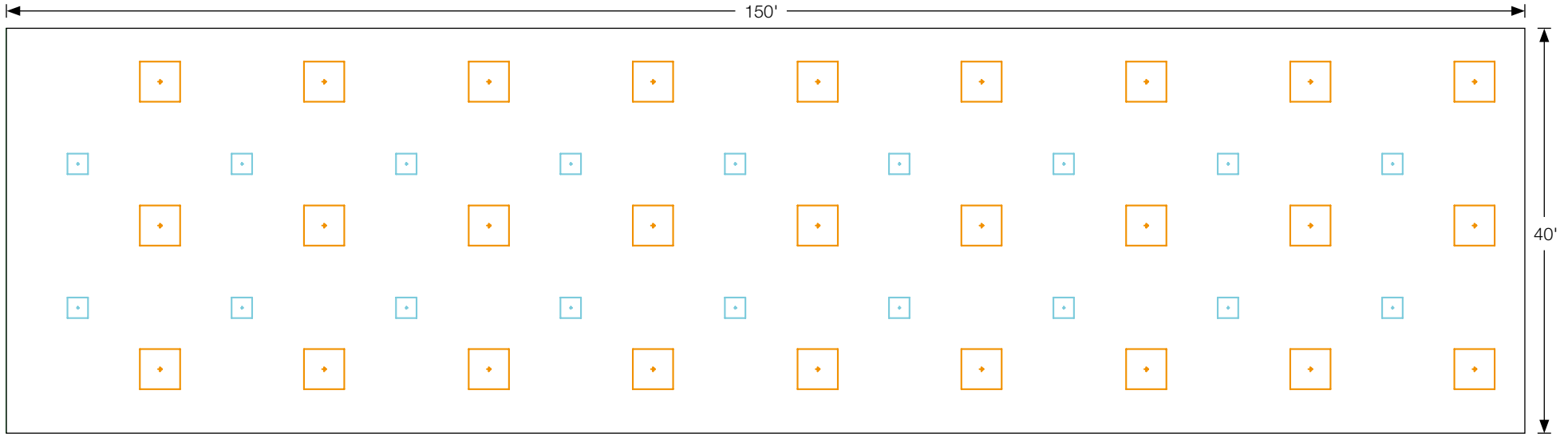

■ HPT 2'x2'
 ■ HPT 4'x4'

	HPT-RSE-2x2-B-835 HPT-RSE-4x4-B-835-60Dim
Average Light Level on Desktop (Footcandles)	39
Average to Minimum on Desktop (Illuminance)	3.5:1
Energy Consumption (Lighting Power Density)	0.49 W/ft ²
Room Size (Area)	150' x 40'

- Ceiling Height: 14'0" AFF
- Room Reflectances: 80/50/20
- Luminaires are recessed into ceiling
- Light levels are initial

Classroom

Application Data

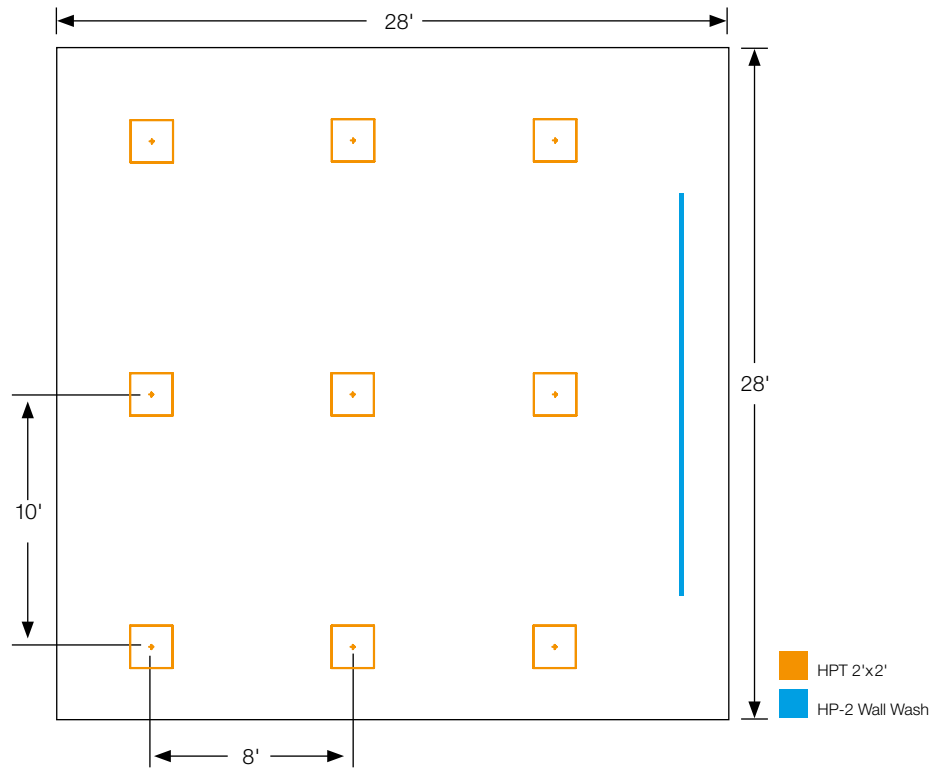

	HP-2-WW-D-K-4ft-V-835 HPT-RES-2X2-B-835
Average Light Level at Workplane (Footcandles)	56
Energy Consumption (Lighting Power Density)	0.51 W/ft ²
Room Size (Area)	28' x 28'

- Ceiling Height: 9'0" AFF
- Room Reflectances: 80/50/20
- Light levels are initial

Private Office

Application Data

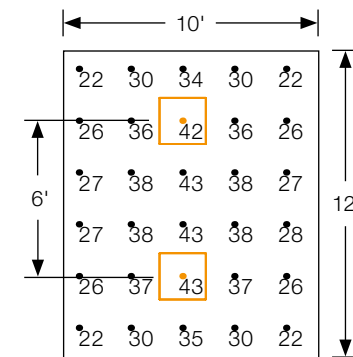

	HPT-RSE-2x2-S-835
Average Light Level at Workplane (Footcandles)	32
Energy Consumption (Lighting Power Density)	0.46 W/ft ²
Room Size (Area)	10' x 12'

- Ceiling Height: 9'0"
- Room Reflectances: 80/50/20
- Light levels are initial

Performance

HPT

HPT-RSE-2'x2'-V-835

Very High Output – 2'x2' Luminaire

Efficacy: 118 lumens per watt

Total Luminaire Output: 6671 lumens

56.6 watts

Peak Candela Value: 2609 @ 0°

CCT: 3500K

CRI: 80

ITL LM79 Report 89598

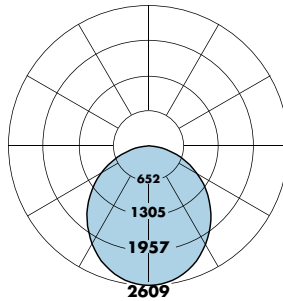

Total Light Output, 3500K, 80 CRI (Lumens)				
	S ¹	B ¹	H ¹	V ²
2'x2'	3521	4527	5122	6671
3'x3'	4632	5765	8524	10791
4'x4'	8332	10371	15335	19412

Power, 3500K, 80 CRI (Watts)				
	S ¹	B ¹	H ¹	V ²
2'x2'	27.7	36.1	41.7	56.6
3'x3'	32.1	40.8	63.0	82.1
4'x4'	55.8	70.9	109.3	142.5

Efficacy, 3500K, 80 CRI (Lumens Per Watt)				
	S ¹	B ¹	H ¹	V ²
2'x2'	127	125	123	118
3'x3'	144	141	135	131
4'x4'	149	146	140	136

S - Standard Output, B - Boosted Standard Output, H - High Output, V - Very High Output

¹ Family Correlation based on HPT 2'x2', 3500K, Very High Output (V) test – 120V

² Based on ITL report: 89598, 91549, & 91550

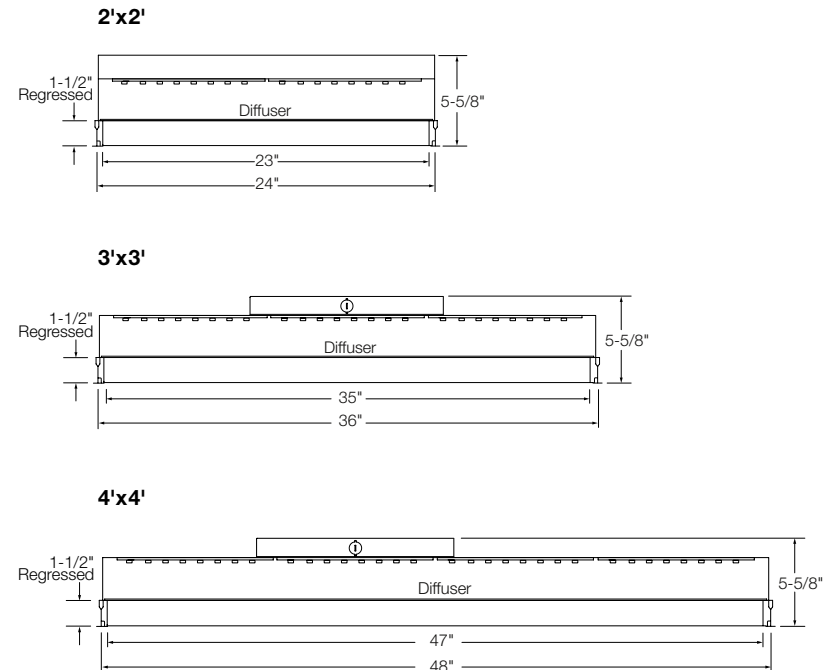



2'x 2' and 4'x4' shown

FINELITE®

Better Lighting

Ordering Guide Example: HPT - RSE - 2'x2' - S - 835 - 96 - 120 - SC - FC-1% - FA100 - C1 - 96 LG - LGD18W - RLA

BODY TYPE			ARRAY TYPE			MECHANICAL FEATURES	
Platform	Series Name	Size	Downlight Output	LED CRI/CCT	Reflector System		
HPT	RSE - Rise	2' x 2' 3' x 3' 4' x 4'	S - Standard B - Boosted Standard H - High V - Very High	830 - 80 CRI min, 3000K 835 - 80 CRI min, 3500K 840 - 80 CRI min, 4000K 930 - 90 CRI min, 3000K 935 - 90 CRI min, 3500K 940 - 90 CRI min, 4000K 8TW - 80 CRI min, Tunable White 9TW - 90 CRI min, Tunable White	96 - 96 Low Gloss White		
ELECTRICAL FEATURES			MOUNTING TYPE			FEATURES	
Voltage	Circuiting ¹	Driver Selection ²	Mounting Method	Ceiling Type	Finish	Emergency Style (Optional)	Special Options (Optional)
120 - 120 Voltage 277 - 277 Voltage 347 - 347 Voltage	SC - Single Circuit	FC-10% - Factory Choice 0-10V, 10% Dim FC-10%-DTO - Factory Choice 0-10V, 10% Dim To Off FC-1% - Factory Choice 0-10V, 1% Dim FC-1%-DTO - Factory Choice 0-10V, 1% Dim To Off LUT-ES1 - Hi-Lume 1% EcoSystem with Soft-on, Fade to Black dimming (LDE1 series) LUT-TW - Lutron LD2 Dali-2 1%, Tunable White	FA50 - Fully Adjustable 50" ⁴ FA100 - Fully Adjustable 100" ⁴ FA150 - Fully Adjustable 150" ⁴ FA200 - Fully Adjustable 200" ⁴ FA250 - Fully Adjustable 250" ⁴ FA300 - Fully Adjustable 300" ⁴ SM - Surface Mount ⁴ DW - Drywall Kit	C1 - 15/16" T-Bar C2 - 9/16" T-Bar C2T - 9/16" Tegular C3 - Screw Slot C4 - Hard Ceiling	96 LG - 96 Low Gloss White	LGD18W - Legrand 18W Battery Back-up ⁵ LGD10W - Legrand 10W Battery Back-up ⁵ BSL722 - Bodine Battery Back-up ⁵ EM/GEN - Emergency to Generator GTD - Generator Transfer Device ⁵	CP - Chicago Plenum RLA - Red List Approved RLD - Declared
		¹ Contact factory for switching options	² Contact factory for compatible driver options not listed above ³ B & V outputs only	⁴ Surface Mount & Pendant (Fully Adjustable) Mount only available for 2'x2'	⁵ Available for 2'x2' only		

The Finelite Difference



10-year performance-based warranty



Ships in 10 working days for standard orders



Tailored Lighting



Buy American Act Compliance