

HP-2 Acoustic Baffle Lit & Unlit Installation Instructions

Regressed Luminaires Use Same Instructions

Overview

NOTES

- All power connections should be installed according to local/national codes by a Certified Electrician.
- This installation requires **proper support** as each luminaire is being installed.



HELPFUL
VIDEO



0-10V
Dimming



Aircraft Cable
Installation - Lit



Aircraft Cable
Installation - Unlit

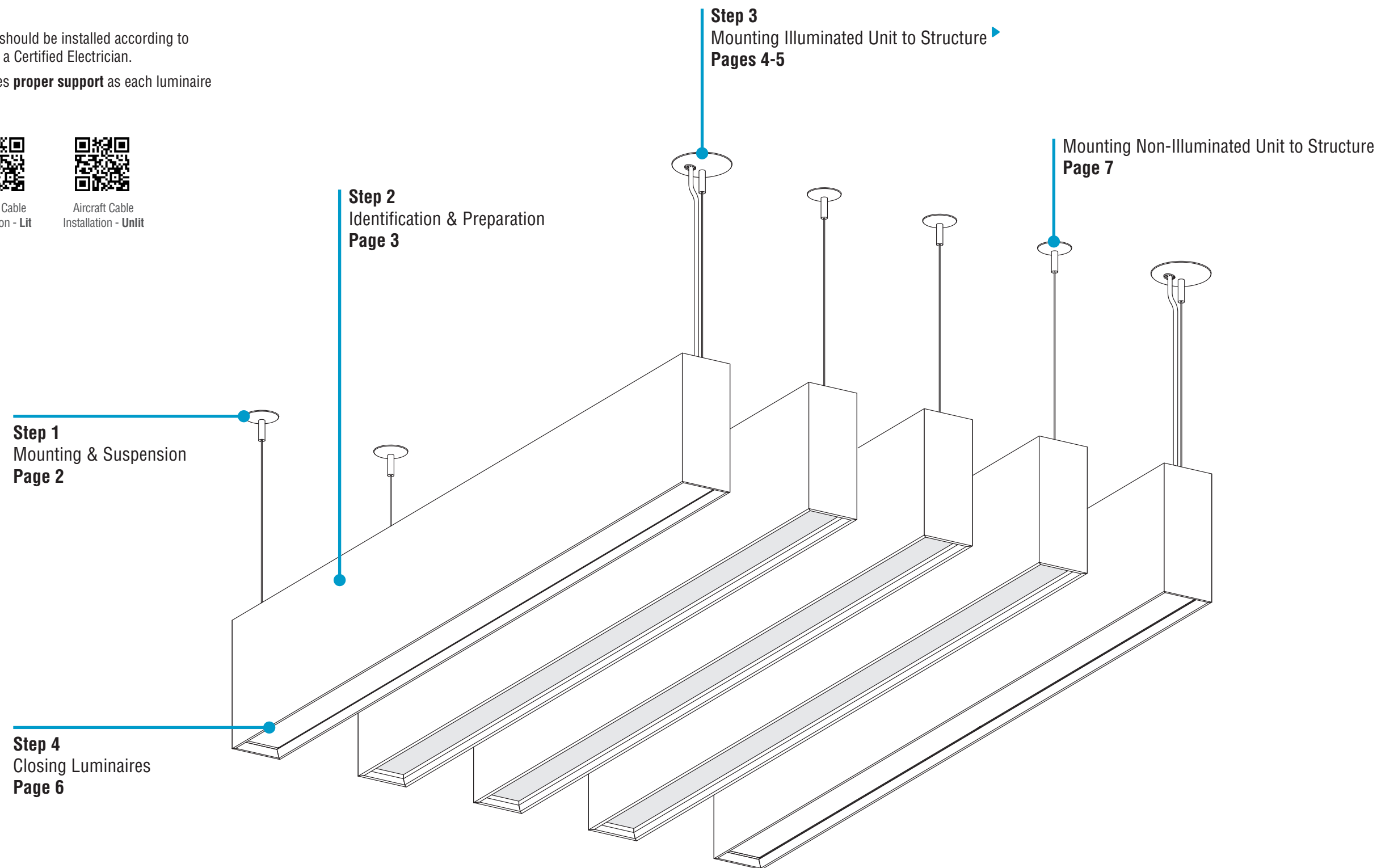

HP-2 Acoustic Baffle Lit & Unlit Installation Instructions

Step 1 - Mounting & Suspension

Mounting Options

Option 1 T-Bar Mounting - GridBox™ and Caddy Clips

- **Illuminated Unit Only:** Install GridBox™ and electrical conduit at feed locations.
- Install caddy clips at mounting point locations.
- All caddy clips are to be secured to structure, per local building codes.

Option 2 Drywall (C4) or other hard surfaces* - J-Box and Anchor Bolts

- **Illuminated Unit Only:** Install J-Box and electrical conduit at feed locations.
- Install anchor bolts at mounting point locations.
- All anchor bolts are to be secured to structure, per local building codes.

* Other hard surfaces include: wood, sheet metal panels, steel beams, concrete, or masonry. Use hardware appropriate for each surface material type.

Suspension Locations

X = Suspension Dimensions

Refer to Record Drawings and building plans to determine exact mounting, suspension points, and power feed locations.

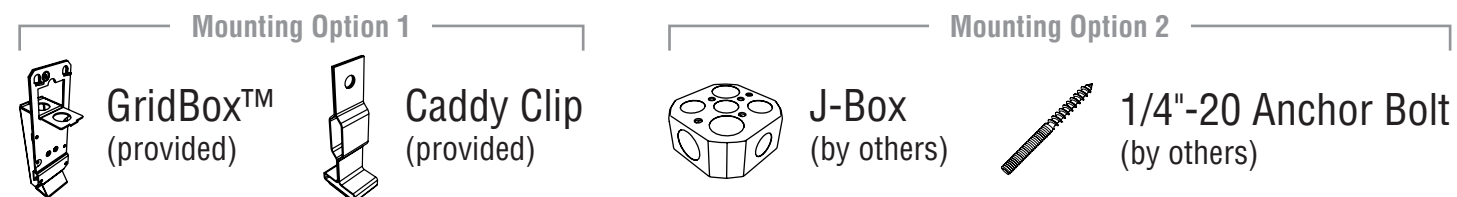
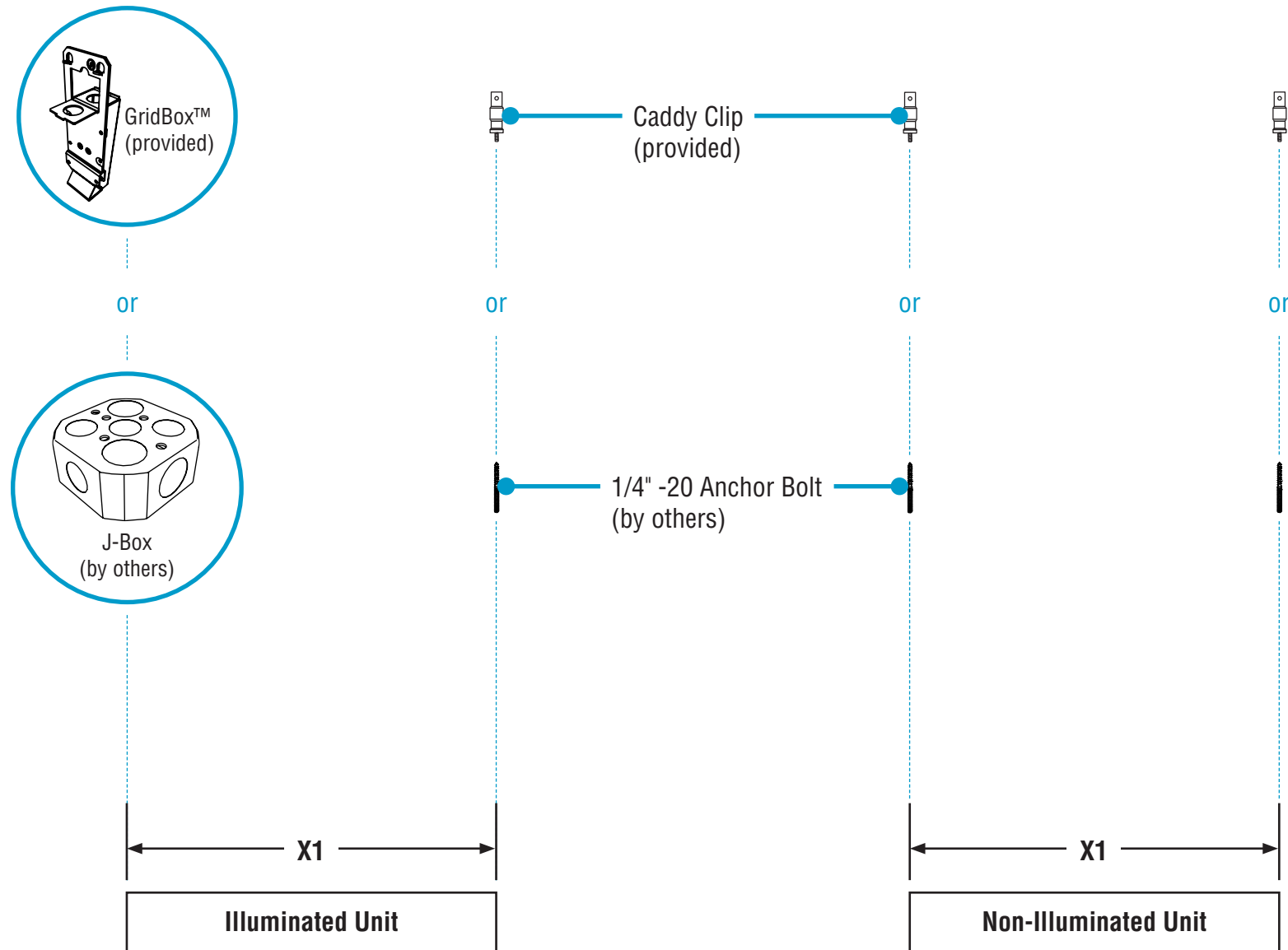

HP-2 Acoustic Baffle Lit Installation Instructions

Step 2 - Identification & Preparation

A. Identify Luminaires



Arrange luminaires in order according to ID# at their install locations.

CAUTION

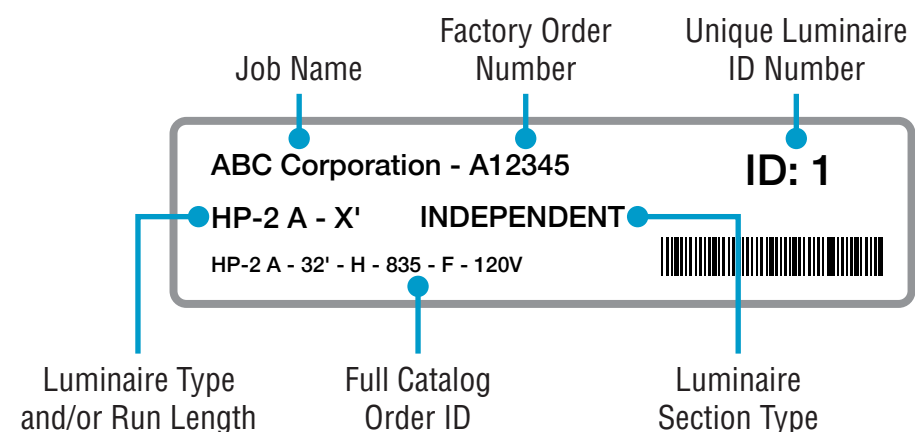

- Identify all luminaires by their ID label that can be found on the box, the protective bag, and inside the luminaire.
- **NOTE:** Exact location of labels in these areas may vary.
- Remove all luminaires from their box.
- Refer to Record Drawings that can be found in the hardware kit.

B. Remove Diffusers Top-Down View

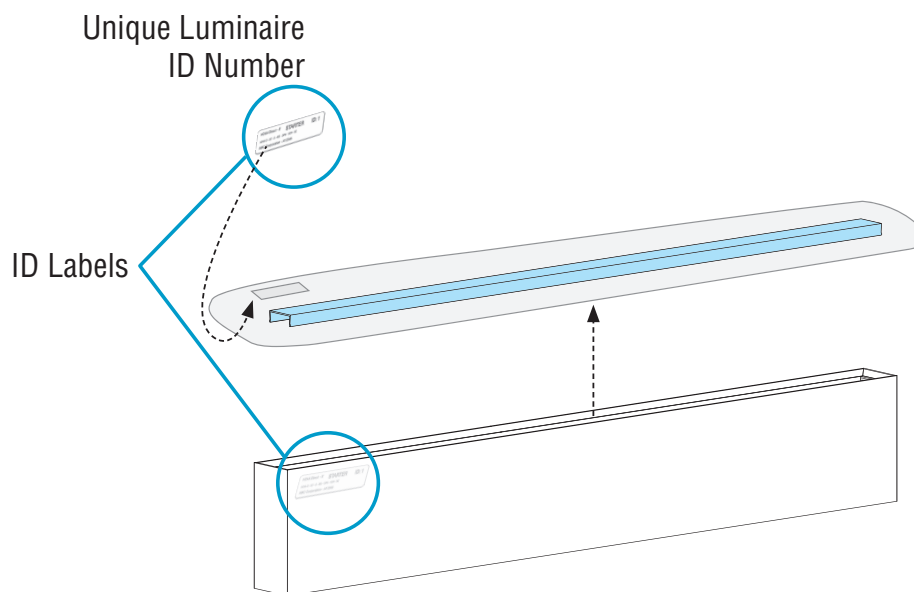

- Carefully remove all diffusers, keeping them inside their protective bag.
- Set aside all diffusers to prevent them from getting dirty or damaged.
- Ensure diffusers can be clearly identified back to their corresponding luminaire.



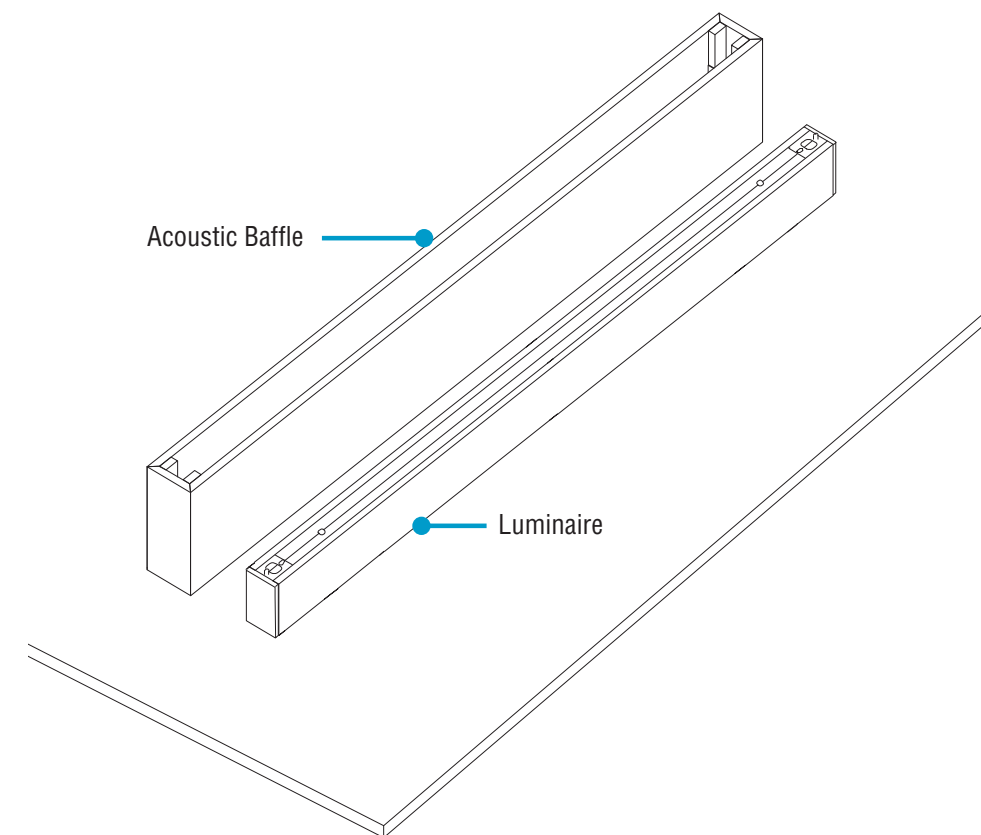







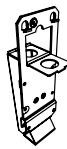



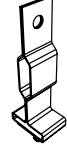

C. Setup

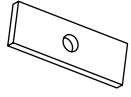
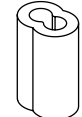

- Remove Acoustic wrap from fixture to install suspension hardware.

Kitted Hardware

- Finelite has provided items listed here, with their Finelite part numbers. These items can be found in separate boxes shipped with the luminaire.
- Account for all parts and set aside until they are needed.
- All other hardware needed for this installation will be by others.

Mounting Option 1		Mounting Option 2			
	GridBox™ Part# 89159		3-1/2" Canopy Part# 89191		5" Canopy Part# 94085
	Dual GridBox™ Part# 89199 Mounting & Suspension p. 2, Step 1		3-1/2" Dual Feed Canopy Part# 89192 Mounting Illuminated Unit p. 4-5, Step 3		5" Dual Feed Canopy Part# 94145 Mounting Illuminated Unit p. 4-5, Step 3
	Caddy Clip C1 Ceiling - Part# 94001 C2 Ceiling - Part# 94020 C3 Ceiling - Part# 94029 Mounting & Suspension p. 2, Step 1		3-1/2" T-Bar Support Canopy Part# 89193 Mounting Illuminated Unit p. 4-5, Step 3 Mounting Non-Illuminated Unit p. 7		2" Drywall Support Canopy Part# 94017 Mounting Illuminated Unit p. 4-5, Step 3 Mounting Non-Illuminated Unit p. 7
					Gripper Part# 68129 Mounting Illuminated Unit p. 4-5, Step 3 Mounting Non-Illuminated Unit p. 7
					Safety Bar Part# 93500 Mounting Illuminated Unit p. 4-5, Step 3 Mounting Non-Illuminated Unit p. 7
					Safety Crimp Part# 94514 Mounting Illuminated Unit p. 4-5, Step 3 Mounting Non-Illuminated Unit p. 7
					Cable Bushing Part# 94014
					Aircraft Cable 50" - Part# 94515-12 (Std.) 100" - Part# 94515-14 150" - Part# 94515-18 Mounting Illuminated Unit p. 4-5, Step 3 Mounting Non-Illuminated Unit p. 7
					Slip Ring w/ Set Screw Part# 94015 Mounting Illuminated Unit p. 4-5, Step 3
					1/4" Washer Part# 92080 Mounting Non-Illuminated Unit to Structure p. 7
					Screw Part# 94126 Mounting Non-Illuminated Unit to Structure p. 7

HP-2 Acoustic Baffle Lit Installation Instructions

Step 3 - Mounting Illuminated Unit to Structure

A. Install Aircraft Cables

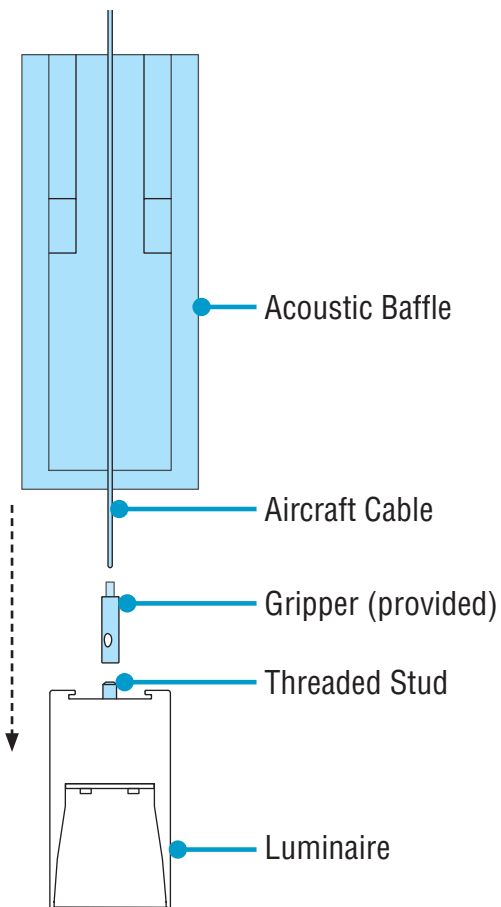

- Attach grippers onto threaded stud.
- Feed the aircraft cable through gripper.

B. Crimp Cables Top-Down View

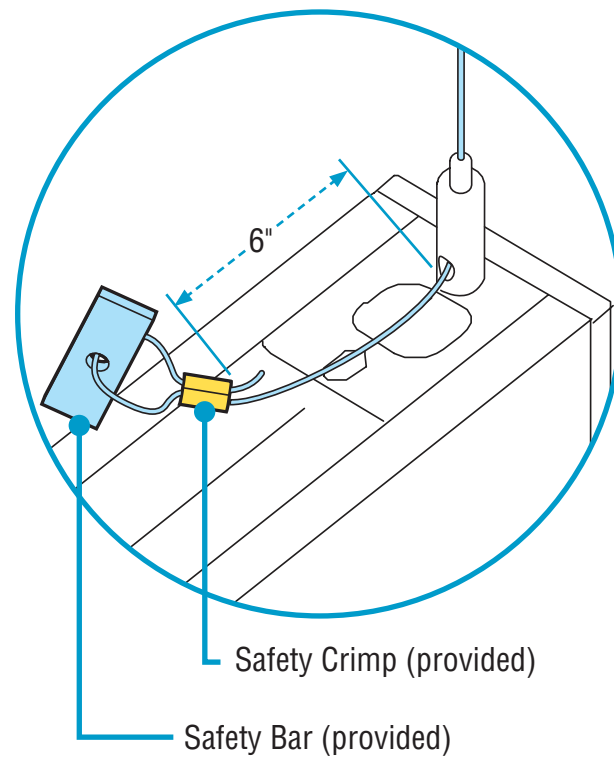

- Estimate required length of cable and add 8"
- Loop cable through safety crimp and safety bar, then back through safety crimp.
- Crimp, then cut excess cable.
- Slide acoustic baffle onto luminaire. Aircraft cable exits through the top of acoustic baffle

OPTIONAL Flexible Mount pendant brackets are adjustable for custom mounting locations.

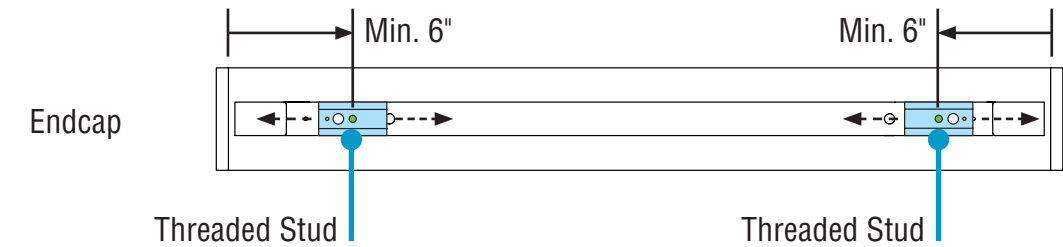

- **NOTE:** Minimum 6" from end of housing to threaded stud on pendant bracket.
- Maximum distance depends on length of luminaire (see table).

Luminaire Length	Max.
4' - 8'	24"

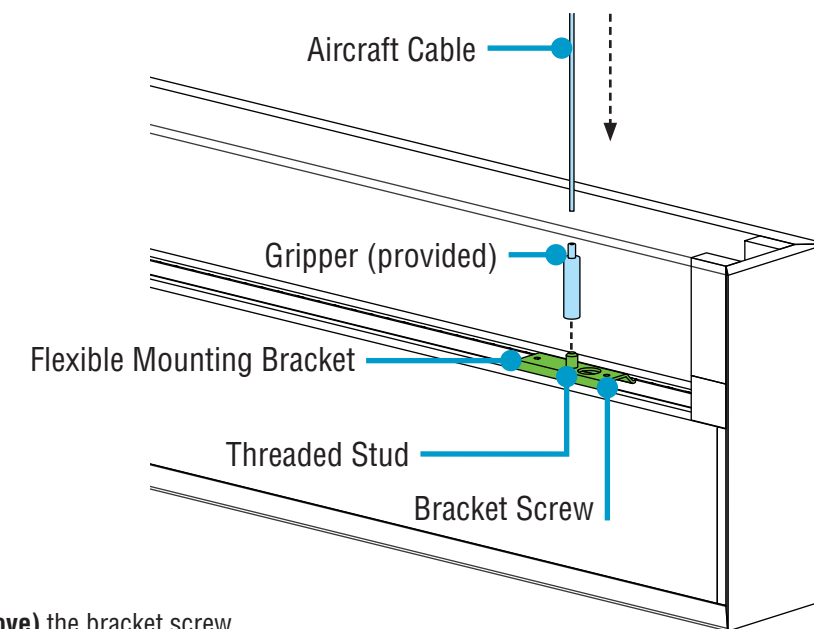

- Loosen (**but do not remove**) the bracket screw.
- Slide flexible mount pendant bracket to desired location and tighten screw to secure.
- Attach gripper onto threaded stud.
- Feed bushing/cable assembly through gripper by depressing top of gripper.
- Allow excess cable to rest atop luminaire. Crimp then trim, if necessary.

Mounting Option 1 (shown)

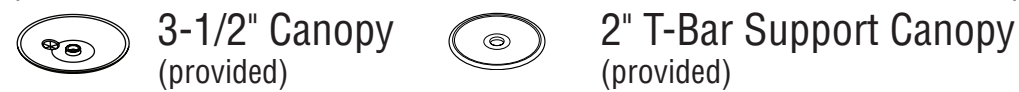

Mounting Option 2

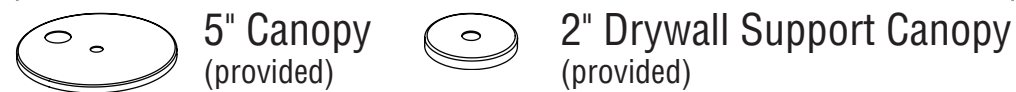

Aircraft Cable
Installation - Lit

HP-2 Acoustic Baffle Lit Installation Instructions

Step 3 - Mounting Illuminated Unit to Structure

C. Mount Illuminated Unit to Structure Bottom-Up View

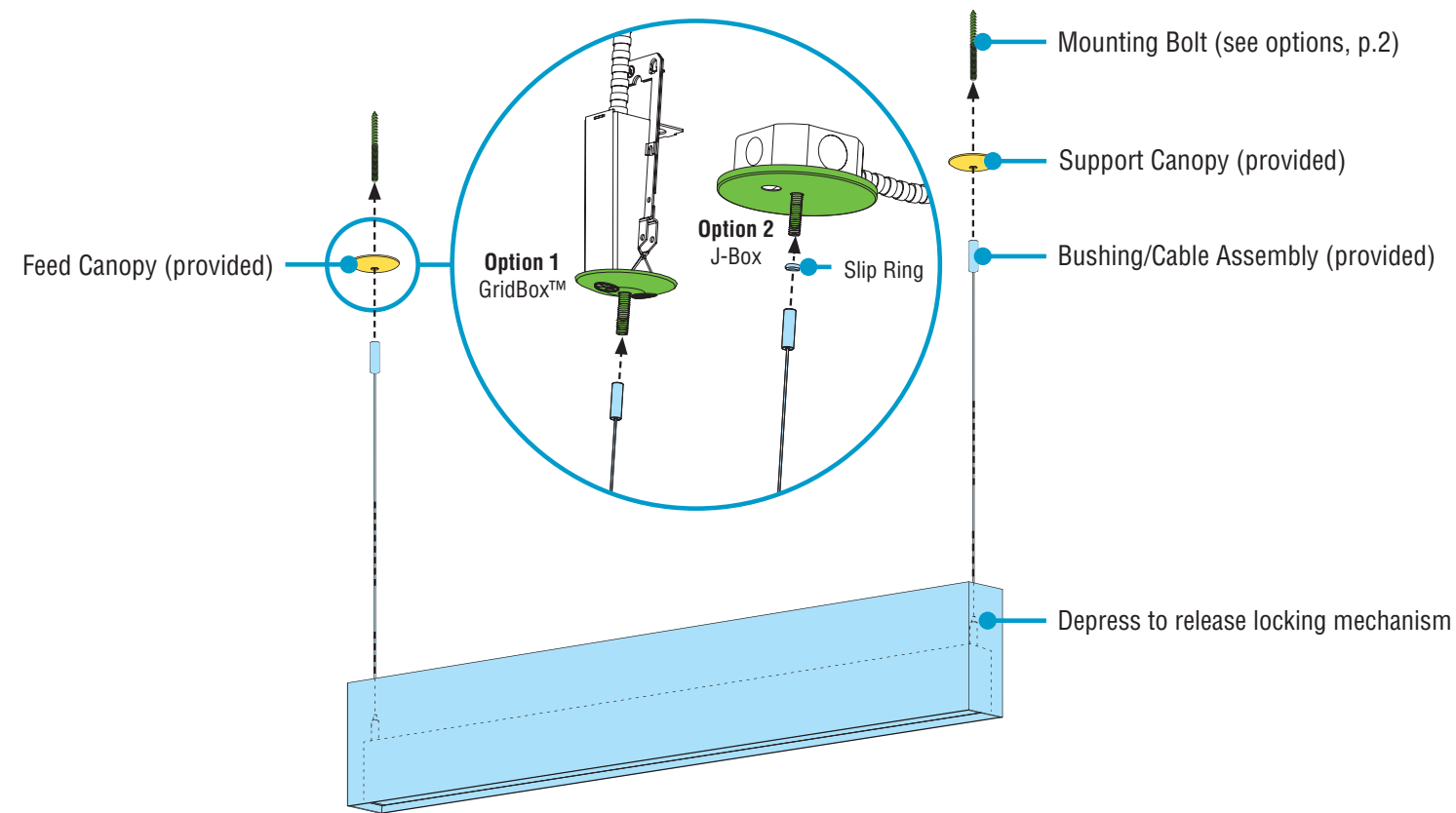

- Slide canopy appropriate for electrical type onto mounting bolt (anchor bolt or caddy clip bolt).
- **(Option 2)** Thread the slip ring onto bushing.
- Thread the bushing/cable assembly onto mounting bolts.
- While properly supporting luminaire, maneuver luminaire to ceiling.
- Level each luminaire to desired height by depressing top of gripper to adjust cable length.

D. Mounting Illuminated Unit to Structure Bottom-Up View

WIRING LEGEND		
Black	Hot	Line Voltage
White	Neutral	Line Voltage
Green	Ground	
Grey	Dimming	0-10V DC
Purple	Dimming	0-10V DC

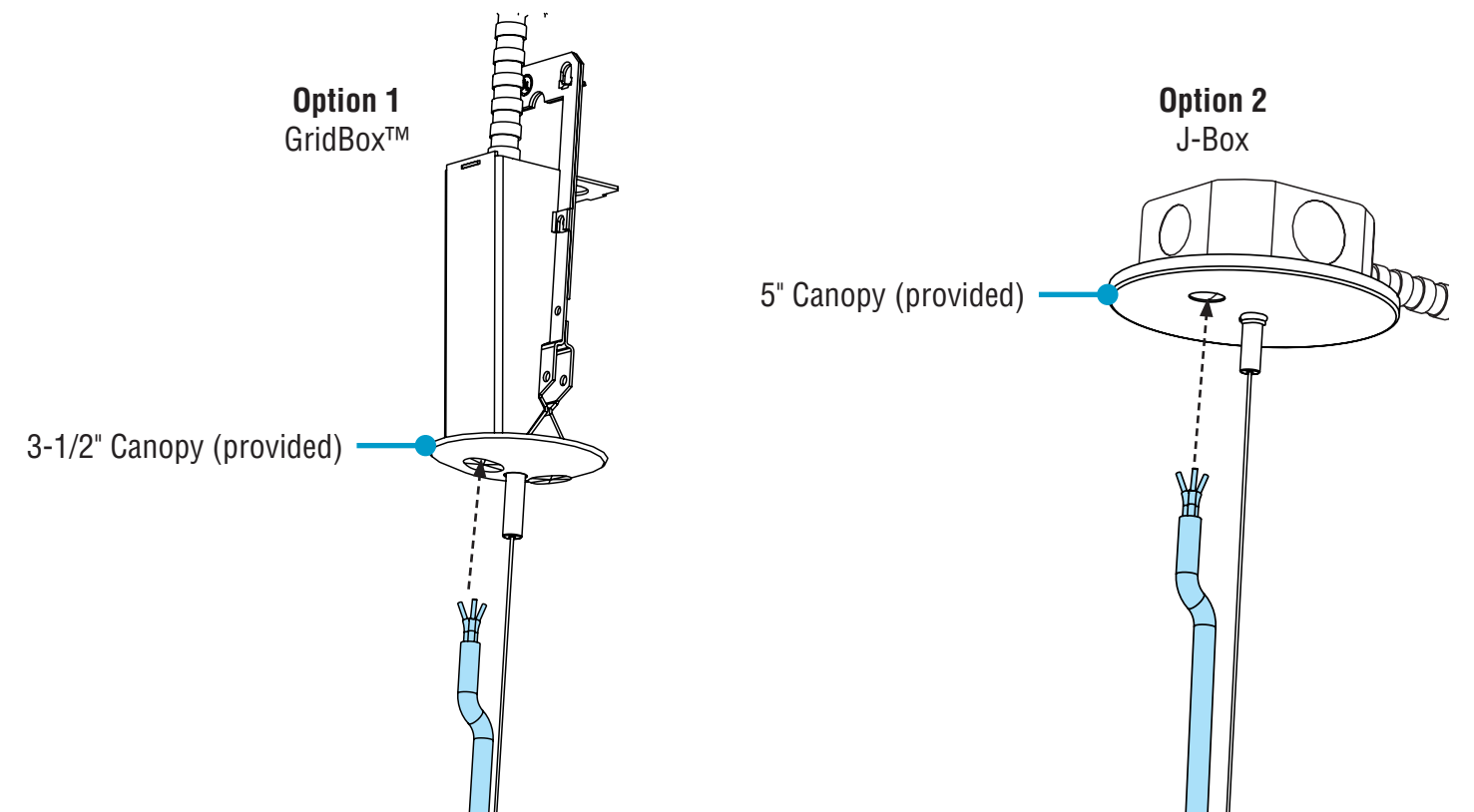

- **(Option 1)** Feed power cord through the 3-1/2" canopy and connect wires inside the GridBox™.
- **(Option 2)** Feed power cord through the 5" canopy and connect wires inside the J-Box.

Mounting Option 1 (shown)

3-1/2" Canopy (provided)

2" T-Bar Support Canopy (provided)

Mounting Option 2

5" Canopy (provided)

2" Drywall Support Canopy (provided)

Slip Ring w/ Set Screw (provided)

Bushing/Cable Assembly (provided)

Gripper (provided)

Safety Crimp (provided)

Safety Bar (provided)



0-10V Dimming

HP-2 Acoustic Baffle Lit Installation Instructions

Step 4 - Final Step

Replace Diffusers Bottom-Up View

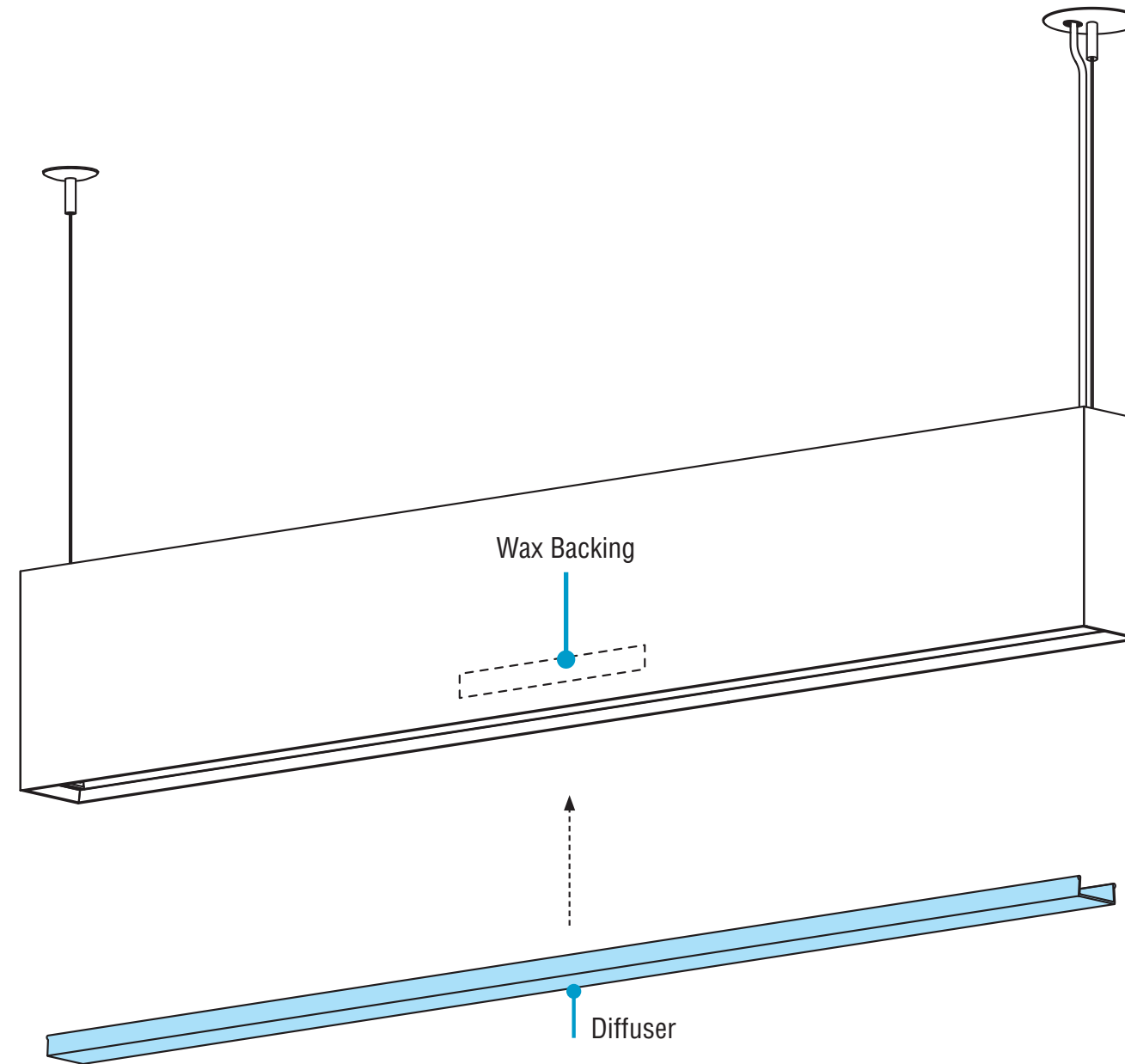

- **NOTE:** If your installation includes a battery backup, please see addendum (98333) that should be included with your kitting package.
- Peel off wax backing from double sided tape, which is located on the internal side of acoustic baffle, and apply pressure firmly onto luminaire. For easier access to tape, lift the acoustic sleeve up above the luminaire.
- Remove diffuser from protective plastic bag.
- **CAUTION:** Wear gloves to keep diffuse surface clean.
- **CRITICAL:** Be sure to install correct diffuser to its corresponding luminaire ID.
- Install diffuser into luminaire body, ensuring it snaps into place.
- Turn on power to luminaires.

HP-2 Acoustic Baffle Unlit Installation Instructions

Mounting Non-Illuminated Unit to Structure

Mount Non-Illuminated Unit to Structure Bottom-Up View

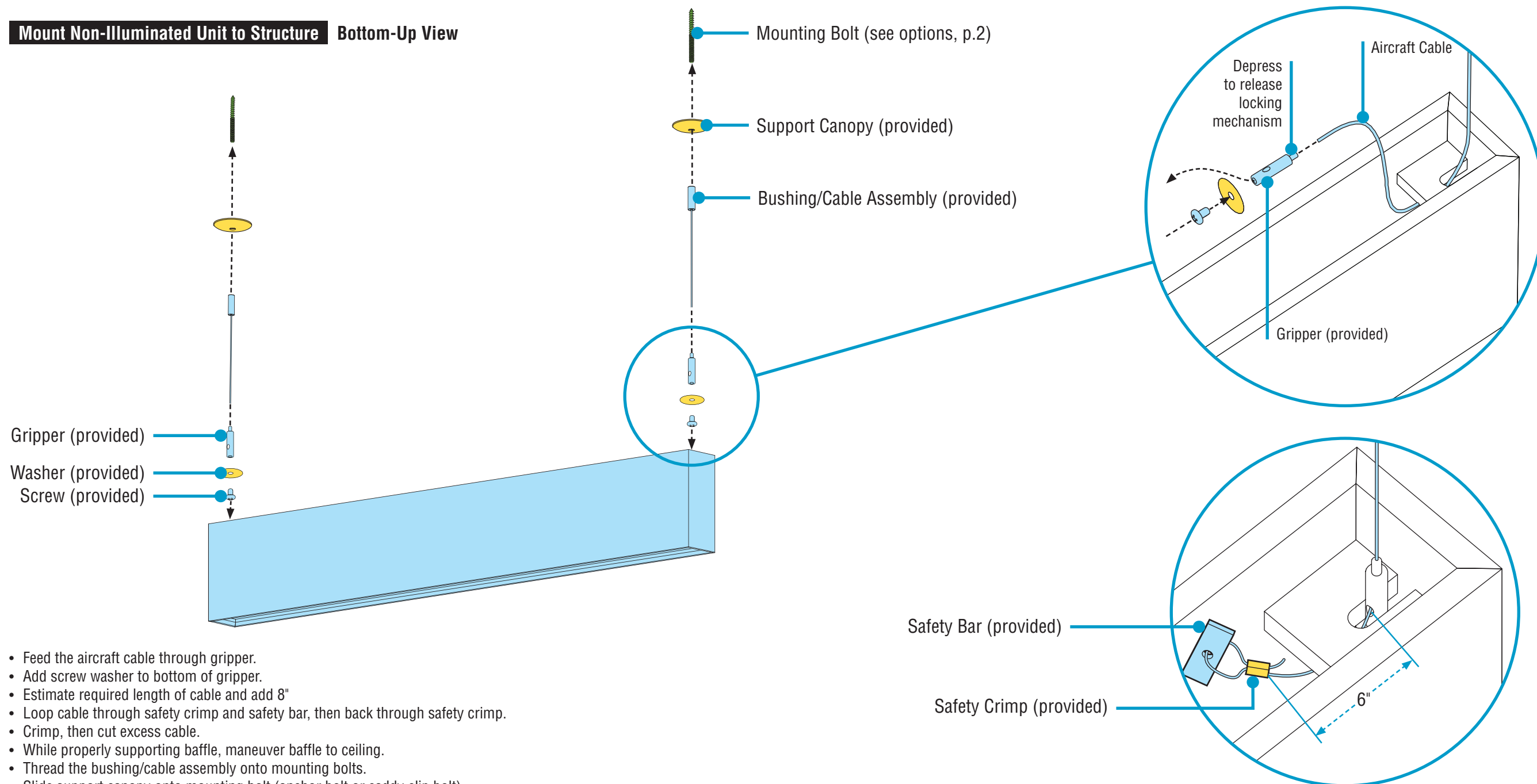

- Feed the aircraft cable through gripper.
- Add screw washer to bottom of gripper.
- Estimate required length of cable and add 8"
- Loop cable through safety crimp and safety bar, then back through safety crimp.
- Crimp, then cut excess cable.
- While properly supporting baffle, maneuver baffle to ceiling.
- Thread the bushing/cable assembly onto mounting bolts.
- Slide support canopy onto mounting bolt (anchor bolt or caddy clip bolt).
- Level each baffle to desired height by depressing top of gripper to adjust cable length.

• Refer to pg.4 for safety bar install

Mounting Option 1 (shown)



2" T-Bar Support Canopy (provided)

Mounting Option 2



2" Drywall Support Canopy (provided)



Slip Ring w/ Set Screw (provided)



Bushing/Cable Assembly (provided)



Gripper (provided)



Safety Crimp (provided)



Washer (provided)

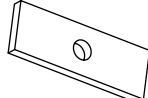

Safety Bar (provided)



Screw (provided)

