

# FINELITE

## High Performance Recessed (HPR LED) 2x2, High Output (H), Very High Output (V)



Date

Project

Type

Comments



Refer to page 2 for all door styles

### DESCRIPTION

HPR LED is a highly efficient recessed luminaire delivering excellent visual comfort and outstanding performance. Advanced optical design makes HPR LED a powerful solution for low-ceiling applications and eliminates the shadows common to other LED recessed products. This Product is enrolled in the International Living Future Institute (ILFI) Declare 2.0 Program and is third-party verified with options achieving Red List Approved and Declared status.

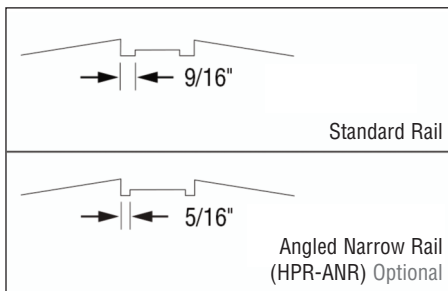
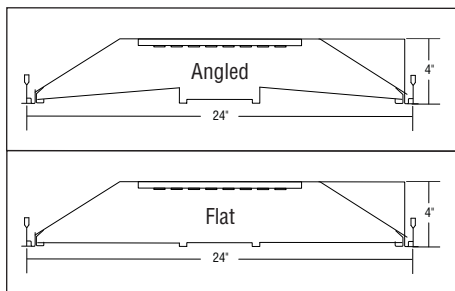

### DIMENSIONS

### ANGLED NARROW RAIL OPTION

Available in angled door style with the same center optic choices. The optional narrow rails are approximately 5/16" wide. The standard center rails are approximately 9/16" wide.

### 100% SERVICEABLE FROM BELOW

The replaceable light engine and driver are easy to access from below the ceiling.

### ORDERING GUIDE

Sample Number: HPR LED - A - 2x2 - DCO - H - 835 - 277V - SC - C1 - OBO - RLA

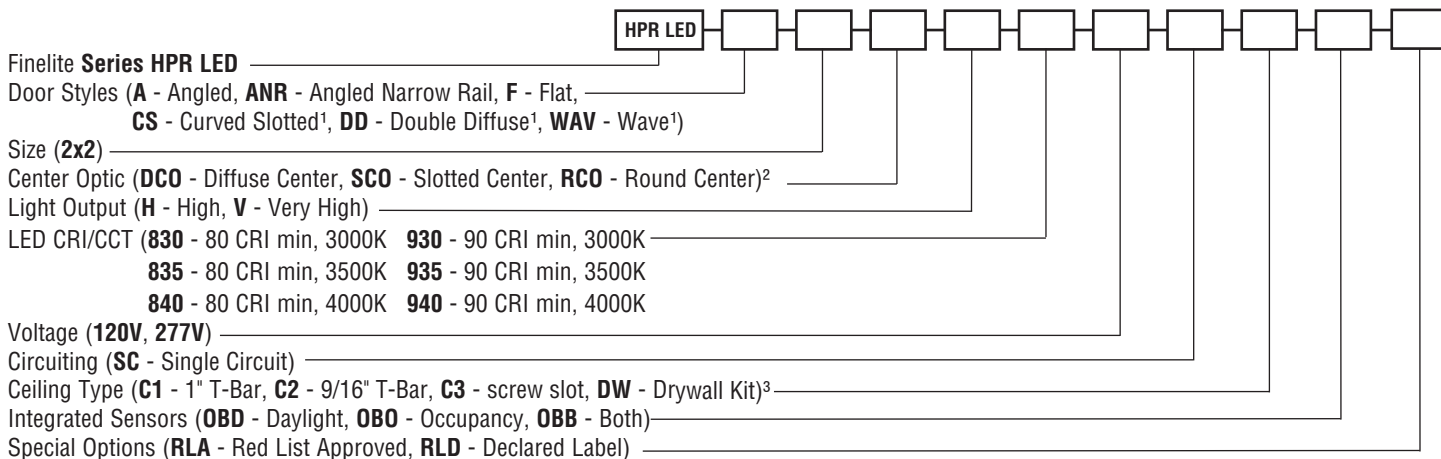

<sup>1</sup> Curved Slotted, Double Diffuse and Wave door not available with Center Optic options  
<sup>2</sup> Only available on Angled (A), Angled Narrow Rail (ANR), and Flat (F) door options  
<sup>3</sup> Surface Mount available

A brand of **legrand**

Finelite, Inc. • 30500 Whipple Road • Union City, CA 94587-1530 • (510) 441-1100 • Fax: (510) 441-1510 • www.finelite.com

## DOOR STYLES

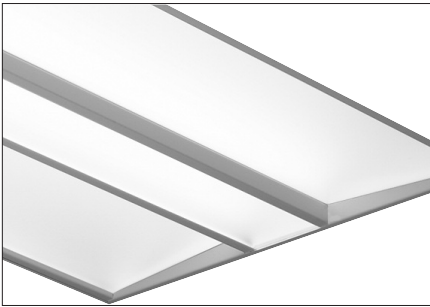

**A - Angled**  
**ANR - Angled Narrow Rail**

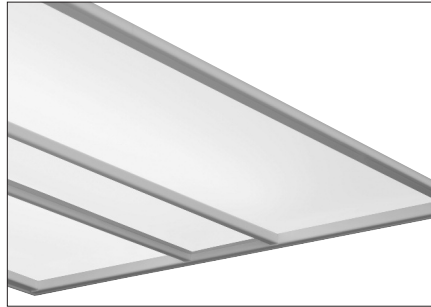

**F - Flat**

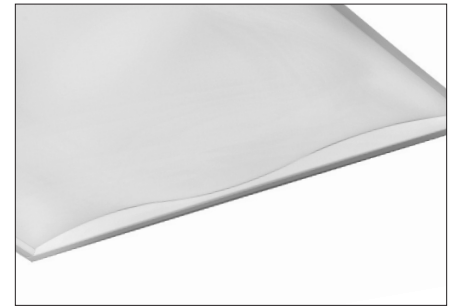

**WAV - Wave**

## DOOR STYLES

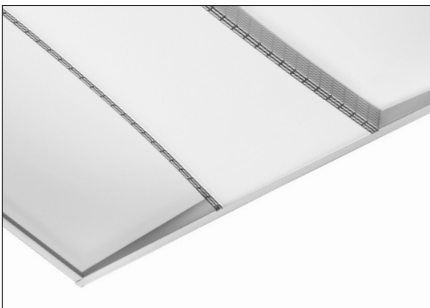

**CS - Curved Slotted**



**DD - Double Diffuse**

## CENTER OPTICS



**DCO - Diffuse Center**



**SCO - Slotted Center**



**RCO - Round Center**

DCO, SCO, and RCO are only available on Angled (A), Angled Narrow Rail (ANR), and Flat (F) doors.

# FINELITE

IC-RATED LED BUY AMERICAN ACT OF 2009 COMPLIANT

## High Performance Recessed (HPR LED) 2x2, High Output (H), Very High Output (V)

### PHOTOMETRY

HPR LED-A-2x2-DCO-V  
Very High output - Angled Rail  
Efficacy: 111 lumens per watt  
Total luminaire output: 6436 Lumens  
58.1 Watts  
Peak Cadela Value: 2574 @ 0°  
CCT: 3500K  
ITL LM79 Report 85142

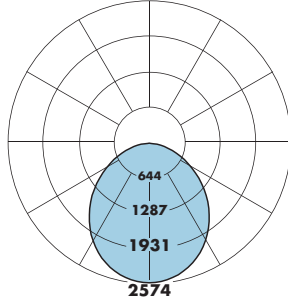

CANDLEPOWER SUMMARY						
	0.0	22.5	45	67.5	ACROSS	Flux
0	2574	2574	2574	2574	2574	
5	2561	2561	2560	2559	2560	243
10	2519	2517	2515	2514	2514	
15	2440	2439	2441	2442	2444	688
20	2332	2333	2337	2344	2347	
25	2199	2199	2207	2217	2224	1016
30	2038	2040	2052	2070	2076	
35	1861	1863	1877	1900	1907	1175
40	1668	1671	1690	1713	1721	
45	1475	1473	1494	1517	1529	1154
50	1272	1272	1293	1314	1323	
55	1075	1074	1093	1109	1116	978
60	880	880	894	909	910	
65	693	696	702	712	718	699
70	519	519	524	532	537	
75	356	354	357	362	367	382
80	211	209	210	213	216	
85	90	87	85	83	85	101
90	0	0	0	0	0	

Angled (A) and Flat (F) Total Light Output, 3500K, 80 CRI (Lumens)	
<b>H*</b>	<b>V**</b>
4942	6436
Power, 3500K, 80 CRI (Watts)	
<b>H*</b>	<b>V**</b>
42.8	58.1
Efficacy, 3500K, 80 CRI (Lumens Per Watt)	
<b>H*</b>	<b>V**</b>
115	111

Lumen Adjustment Factors - 80 CRI	
<b>3000K</b>	0.985
<b>3500K</b>	1.000
<b>4000K</b>	1.032

Lumen Adjustment Factors - 90 CRI	
<b>3000K</b>	0.746
<b>3500K</b>	0.760
<b>4000K</b>	0.789

Apply a lumen adjustment factor to calculate lumens for the desired CCT and CRI.

\* Family Correlation based on 3500K Very High Output (V) test - 120V.  
\*\* Based on source ITL report: 85142

Angled Narrow Rail (ANR) Total Light Output, 3500K, 80 CRI (Lumens)	
<b>H*</b>	<b>V<sup>‡</sup></b>
4766	6207
Power, 3500K, 80 CRI (Watts)	
<b>H*</b>	<b>V<sup>‡</sup></b>
42.9	58.3
Efficacy, 3500K, 80 CRI (Lumens Per Watt)	
<b>H*</b>	<b>V<sup>‡</sup></b>
111	106

\* Family Correlation based on 3500K Very High Output (V) test - 120V.  
‡ Based on source ITL report: 85148

**H - High Output, V - Very High Output**

### SAMPLE LUMEN ADJUSTMENT CALCULATION

High Output (H) Angled (A) & Flat (F)  
4000K, 90 CRI

$$\text{Lumen Adjustment Factor} = 0.789$$

$$\text{Total Light Output} = 4942 \text{ lm} \times 0.789 = 3899 \text{ lm}$$

$$\text{Efficacy} = \frac{3899 \text{ lm}}{42.8 \text{ W}} = 91 \text{ lm/W}$$

A brand of **legrand**

Finelite, Inc. • 30500 Whipple Road • Union City, CA 94587-1530 • (510) 441-1100 • Fax: (510) 441-1510 • www.finelite.com

Due to continuing product improvements, Finelite reserves the right to change specifications without notice. Please visit www.finelite.com for most current data.

# FINELITE

## High Performance Recessed (HPR LED) 2x2, High Output (H), Very High Output (V)

Wave (WAV) Total Light Output, 3500K, 80 CRI (Lumens)	
H*	V†
5048	6574
Power, 3500K, 80 CRI (Watts)	
H*	V†
42.9	58.2
Efficacy, 3500K, 80 CRI (Lumens Per Watt)	
H*	V†
118	113

\* Family Correlation based on 3500K Very High Output (V) test - 120V.

† Based on source ITL report: 85836

Curve Slotted (CS) Total Light Output, 3500K, 80 CRI (Lumens)	
H*	V‡
4709	6132
Power, 3500K, 80 CRI (Watts)	
H*	V‡
42.9	58.2
Efficacy, 3500K, 80 CRI (Lumens Per Watt)	
H*	V‡
110	105

\* Family Correlation based on 3500K Very High Output (V) test - 120V.

‡ Based on source ITL report: 86019

Double Diffuse (DD) Total Light Output, 3500K, 80 CRI (Lumens)	
H*	V‡
3958	5154
Power, 3500K, 80 CRI (Watts)	
H*	V‡
42.9	58.3
Efficacy, 3500K, 80 CRI (Lumens Per Watt)	
H*	V‡
92	88

\* Family Correlation based on 3500K Very High Output (V) test - 120V.

‡ Based on source ITL report: 85154

H - High Output, V - Very High Output

Lumen Adjustment Factors - 80 CRI	
3000K	0.985
3500K	1.000
4000K	1.032

Lumen Adjustment Factors - 90 CRI	
3000K	0.746
3500K	0.760
4000K	0.789

Apply a lumen adjustment factor to calculate lumens for the desired CCT and CRI.

### SPECIFICATIONS

**CONSTRUCTION:** Die-formed 20-gauge cold-rolled steel housing. All components are hard-tooled to tolerances of +/- 0.010". UV stabilized weather-strip pile gasket with polypropylene backing. Hinged door frame assembly provides easy access to light arrays and driver compartment for servicing from below. Seismic brackets are integrated into the luminaire assembly. Additional wire entrances are positioned on the ends of the housing to allow easy wiring access for the installer.

**REFLECTORS:** Die-formed 20-gauge cold-rolled steel reflectors are finished in 96LG high reflectance matte white powder coat paint.

**AIR RETURN:** Refer to 2x2 Air Return Tech Sheet for more information. Available with angled (A) and flat (F) luminaire style only.

**OPTICAL SYSTEM:** Components include diffuser panels and a central optic element held in place with a frame constructed from die-formed cold-rolled steel. The diffusers are UV-stabilized and impact-resistant frosted virgin acrylic, 0.120" thick. They are either angled toward the central optic or parallel to the ceiling plane. The center optical element is held in place by sleek steel rails. The standard center rails are approximately 9/16" wide. Optional narrow rails are approximately 5/16" wide. Optional wave door includes frosted acrylic panel that undulates from side to side.

**DOUBLE DIFFUSE:** Visible diffuser: UV-stabilized and impact-resistant frosted virgin acrylic, 0.120" thick. Inner diffuser: 0.120" thick with 60% round perforations white/white.

**DOOR STYLE:** *Curved Slotted (CS) includes perforated rails that slope inward and a diffuse frosted acrylic center optic.*

**CENTER OPTIC OPTIONS:** *Only available with Angled (A), Angled Narrow Rail (ANR), and Flat (F) door styles.*

*Diffuse Center Optic (DCO): UV-stabilized and impact-resistant frosted virgin acrylic.*

*Slotted Center Optic (SCO): Die-formed cold-rolled steel panel with a 1/16" x 1/2" rectangular hole pattern. Virgin acrylic overlay.*

*Round Center Optic (RCO): Die-formed cold-rolled steel panel with precision-punched 3/32" round hole pattern arranged in staggered formation. Virgin acrylic overlay.*

**LIGHT OUTPUT:** Two lumen packages available, High Output (H), and Very High Output (V). A separate chart summarizes lumen distribution and wattage. Light engines are replaceable.

**LUMEN MAINTENANCE:** 90% of initial light output (L90) at 100,000+ hours; 70% of initial light output (L70) at 200,000+ hours.

**DRIVER:** Replaceable 120V/277V Constant Current Reduction dimming driver standard. Can be wired dimming or non-dimming. 0-10V dimming controls with a range of 10%- 100%. Dimming to 1% available, consult factory. Driver is fully accessible from below the ceiling. Power Factor: ≥0.9. Total Harmonic Distortion (THD): <20%. Expected driver lifetime: 100,000 hours.

**LUTRON DRIVER OPTIONS:** **LUTES1** (Hi-lume 1% EcoSystem with Soft-On, Fade to Black dimming (LDE1 series)); **LUTES5** (5-Series 5% EcoSystem (LDE5 Series)), **LUT2W** (Hi-lume 1% 2-wire, 120V forward phase dimming (LTEA series)); Contact factory for availability of discontinued Lutron drivers, L3DA-3-wire and L3DA EcoSystem.

**ELECTRICAL:** Optional emergency to generator/inverter wiring, internal generator transfer switch, nightlight wiring, step-dimming driver, backup battery. Chicago Plenum option. Factory-choice low-profile backup battery available. Bodine BSL722 battery pack also available. Backup batteries deliver 2199 lumens. One half of the 2x2 will be illuminated in emergency mode.

**INTEGRATED SENSORS:** Integrated PIR (Passive Infrared) occupancy and/or daylight sensors available. Refer to Occupancy Sensor and Daylight Sensor tech sheets for more info.

**MOUNTING:** Standard flange design works with most lay-in ceiling types. Integral pry-out tabs secure the luminaire to the ceiling grid from above. Tie-in locations for tie-wire on all corners. Consult local code for appropriate tie-wire recommendations. Drywall Kit available. Surface mount and air return versions available; refer to separate tech sheets.

**FINISH:** Housing and door assembly painted with 96 LG high reflectance matte white powder coat paint. Optional adder: Anti-microbial paint. Contact factory.

**FEED:** Optional whips (with flex connectors) supplied in a maximum of 11' lengths. Lead Wires.

**LABELS:** Luminaire and electrical components are ETL-listed conforming to UL 916, 1598, 8750, 924 in the U.S.A. and CAN/CSA C22.2 No. 205, 250, and 141 in Canada. In accordance with NEC Code 410.73 (G), this luminaire contains an internal driver disconnect. Damp Location. IC-rated. Finelite products use electronic components that are RoHS compliant, and the mechanical components of the luminaire have been verified to not knowingly contain any restricted substances listed per RoHS Directive 2011/65/EU. Finelite makes the specification process easy when putting healthier products on your projects. Simply add – **RLA** (Red List Approved) or – **RLD** (Declared Label) to your part number.

**WEIGHT:** 16 lbs maximum.

**DLC QUALIFIED:** Configurations of this product are listed on the DLC Qualified Products List (QPL). [www.designlights.org/search](http://www.designlights.org/search)

**10-YEAR WARRANTY:** 10-year performance-based warranty on **High Output** with all standard components. Optional accessories such as emergency battery packs are covered by their individual manufacturer warranties.

**5-YEAR WARRANTY:** 5-year performance-based warranty on **Very High Output** with all standard components. Optional accessories such as emergency battery packs are covered by their individual manufacturer warranties.

