

# FINELITE

## Tunable White High Performance Recessed (HPR LED) 1x4

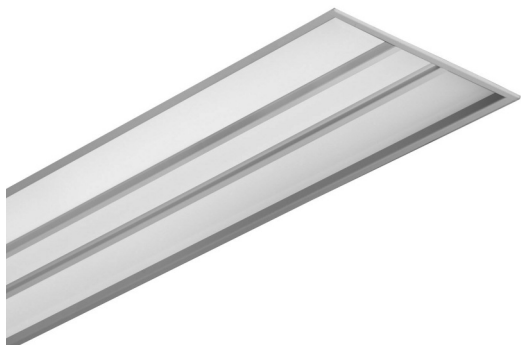

Refer to page 3 for all door styles

Date

Project

Type

Comments

### DESCRIPTION

HPR LED is a highly efficient, recessed luminaire delivering excellent visual comfort and outstanding performance. Advanced optical design makes HPR LED a powerful solution for low-ceiling applications and eliminates the shadows common to other LED recessed products.

### ORDERING GUIDE

Sample Number: HPR LED - A - 1x4 - DCO - B - 8TW - 277V - SC - C1

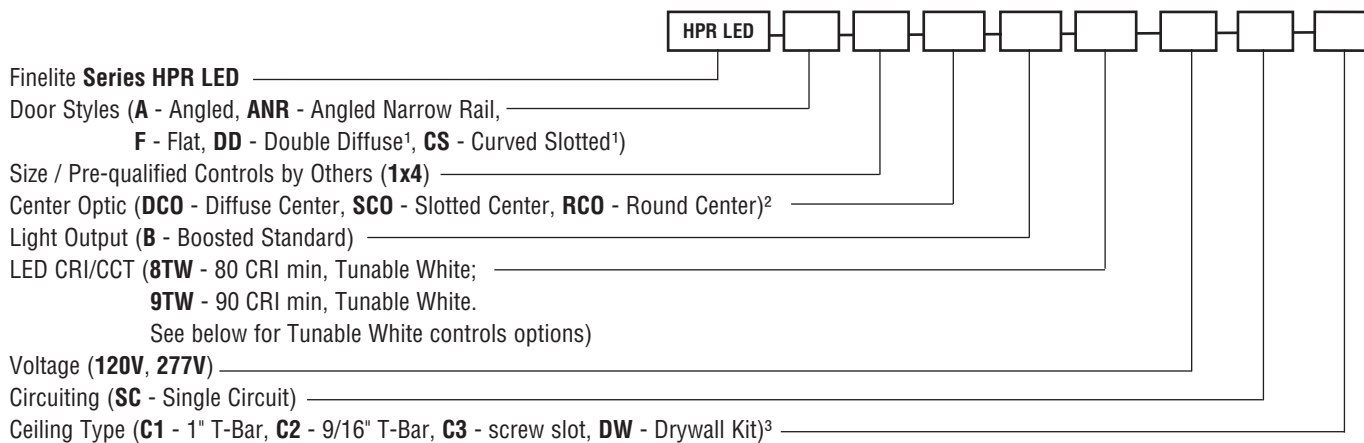

<sup>1</sup> Not available with Center Optic options

<sup>2</sup> Only available on Angled (A), Angled Narrow Rail (ANR), and Flat (F)

<sup>3</sup> Surface Mount available

### TUNABLE WHITE CONTROLS OPTIONS: SELECT ONE



FineTune controller with FineTune DMX Driver

OR

- Controls by others with pre-qualified DMX driver
- Controls by others with pre-qualified DALI driver
- Controls by others with pre-qualified PoE setup
- Controls by Lutron with pre-qualified Lutron driver

A brand of Legrand

Finelite, Inc. • 30500 Whipple Road • Union City, CA 94587-1530 • (510) 441-1100 • Fax: (510) 441-1510 • www.finelite.com

# FINELITE

## Tunable White High Performance Recessed (HPR LED) 1x4

### LUMINAIRE FEATURES

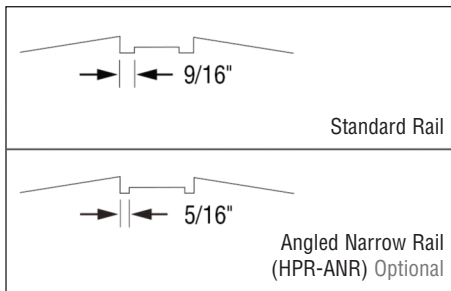
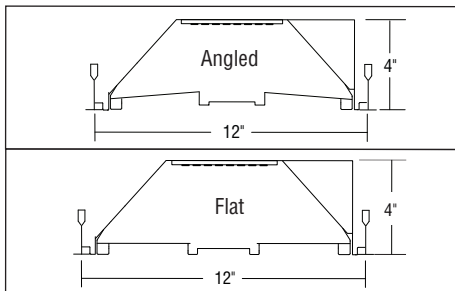

### DIMENSIONS

### ANGLED NARROW RAIL OPTION

Available in angled door style with the same center optic choices. The optional narrow rails are approximately 5/16" wide. The standard rails are approximately 9/16" wide.

### 100% SERVICEABLE FROM BELOW

The replaceable light engine and driver are easy to access from below the ceiling.

### TUNABLE WHITE FEATURES

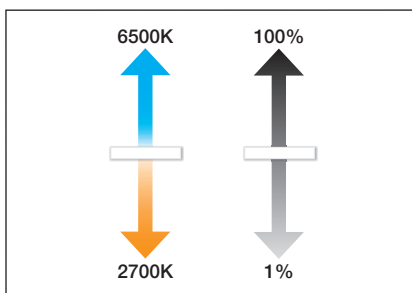
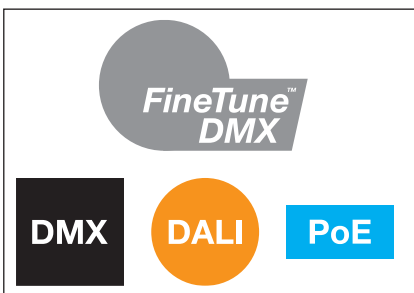

### MULTIPLE CONTROL ARCHITECTURES

Finelite's FineTune™ DMX, qualified DMX, DALI (open and proprietary), or PoE (Power over Ethernet).

### TUNABLE WHITE

Any CCT between 2700K and 6500K with excellent CRI and R9 values; dimming from 100% to 1%.

### FINETUNE SYSTEM

Award-winning control system, which includes intuitive wall mounted controller, power control center, driver, and mobile app to easily tailor lighting to match user preference.

### DMX CONNECTION

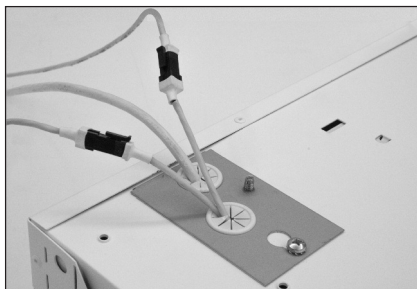

# FINELITE

## Tunable White High Performance Recessed (HPR LED) 1x4

### DOOR STYLES

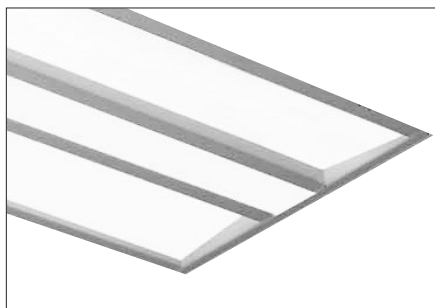

**A - Angled**  
**ANR - Angled Narrow Rail**

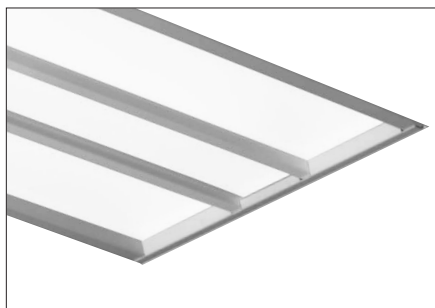

**F - Flat**



**DD - Double Diffuse**



**CS - Curved Slotted**

### CENTER OPTICS



**DCO - Diffuse Center**



**SCO - Slotted Center**



**RCO - Round Center**

DCO, SCO, and RCO are only available on Angled (A), Angled Narrow Rail (ANR), and Flat (F) doors.

# FINELITE

## Tunable White High Performance Recessed (HPR LED) 1x4

### PHOTOMETRY

HPR LED-F-1x4-DCO-B

Boosted Standard Output - Flat

Total luminaire output: 3985 Lumens

Peak Candela Value: 1625 @ 0°

CCT: 3500K

ITL LM79 Report 85141

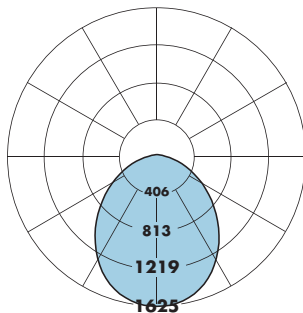

### CANDELA DISTRIBUTION

	0.0	22.5	45.0	67.5	90.0	Flux
0	1625	1625	1625	1625	1625	
5	1616	1617	1618	1618	1618	154
10	1590	1588	1593	1594	1591	
15	1543	1540	1549	1549	1545	435
20	1478	1474	1483	1480	1475	
25	1400	1393	1399	1393	1386	642
30	1304	1297	1299	1288	1277	
35	1194	1189	1184	1168	1156	737
40	1077	1071	1061	1039	1028	
45	953	946	929	907	896	715
50	828	822	800	775	763	
55	703	695	670	646	637	600
60	581	572	548	522	511	
65	461	453	429	401	393	424
70	346	340	315	290	283	
75	239	234	211	190	184	225
80	147	138	117	100	94	
85	65	55	38	32	30	53
90	0	0	0	0	0	

Angled (A) and Flat (F) Total Light Output, 3500K, 80 CRI (Lumens)	
B*	3985
Power, 3500K, 80 CRI (Watts)	
B*	40.8
Efficacy, 3500K, 80 CRI (Lumens Per Watt)	
B*	98

### B - Boosted Standard Output

\* Based on ITL report 85141 3500K, 80 CRI Boosted Standard Output (B) test - 120V.

### Lumen Adjustment Factors - 80 CRI

2700K	0.968
3000K	0.985
3500K	1.000
4000K	1.032
6500K	1.032

### Lumen Adjustment Factors - 90 CRI

2700K	0.731
3000K	0.746
3500K	0.760
4000K	0.789
6500K	0.789

Apply a lumen adjustment factor to calculate lumens for the desired CCT and CRI.

### SAMPLE LUMEN ADJUSTMENT CALCULATION

Boosted Standard Output (B)  
Angled (A) & Flat (F)  
4000K, 90 CRI

*Lumen Adjustment Factor = 0.789*

*Total Light Output =*  
3985 lm x 0.789 = 3144 lm

*Efficacy =*  $\frac{3144 \text{ lm}}{40.8 \text{ W}} = 77 \text{ lm/W}$

A brand of Legrand

Finelite, Inc. • 30500 Whipple Road • Union City, CA 94587-1530 • (510) 441-1100 • Fax: (510) 441-1510 • www.finelite.com

Due to continuing product improvements, Finelite reserves the right to change specifications without notice. Please visit www.finelite.com for most current data.

Page 4

# FINELITE

## Tunable White High Performance Recessed (HPR LED) 1x4

Angled Narrow Rail (ANR) Total Light Output, 3500K, 80 CRI (Lumens)	
<b>B<sup>Y</sup></b>	
	3855
Power, 3500K, 80 CRI (Watts)	
<b>B<sup>Y</sup></b>	
	40.8
Efficacy, 3500K, 80 CRI (Lumens Per Watt)	
<b>B<sup>Y</sup></b>	
	94

**B - Boosted Standard Output**

<sup>Y</sup> Based on ITL report 85147 3500K, 80 CRI Boosted Standard Output (B) test - 120V.

Lumen Adjustment Factors - 80 CRI	
<b>2700K</b>	0.968
<b>3000K</b>	0.985
<b>3500K</b>	1.000
<b>4000K</b>	1.032
<b>6500K</b>	1.032

Lumen Adjustment Factors - 90 CRI	
<b>2700K</b>	0.731
<b>3000K</b>	0.746
<b>3500K</b>	0.760
<b>4000K</b>	0.789
<b>6500K</b>	0.789

Apply a lumen adjustment factor to calculate lumens for the desired CCT and CRI.

Double Diffuse (DD) Total Light Output, 3500K, 80 CRI (Lumens)	
<b>B<sup>±</sup></b>	
	3491
Power, 3500K, 80 CRI (Watts)	
<b>B<sup>±</sup></b>	
	40.6
Efficacy, 3500K, 80 CRI (Lumens Per Watt)	
<b>B<sup>±</sup></b>	
	86

**B - Boosted Standard Output**

<sup>±</sup> Based on ITL report 85153 3500K, 80 CRI Boosted Standard Output (B) test - 120V.

# FINELITE

## Tunable White High Performance Recessed (HPR LED) 1x4

### SPECIFICATIONS

**CONSTRUCTION:** Die-formed 20-gauge cold-rolled steel housing. All components are hard-tooled to tolerances of +/- 0.010". UV stabilized weather-strip pile gasket with polypropylene backing. Hinged door frame assembly provides easy access to light arrays and driver compartment for servicing from below. Seismic brackets are integrated into the luminaire assembly. Additional wire entrances are positioned on the ends of the housing to allow easy wiring access for the installer.

**REFLECTORS:** Die-formed 20-gauge cold-rolled steel reflectors are finished in 96LG high reflectance matte white powder coat paint.

**AIR RETURN:** Refer to 1x4 Air Return Tech Sheet for more information.

**OPTICAL SYSTEM:** Components include diffuser panels and a central optic element held in place with a frame constructed from die-formed cold-rolled steel. The diffusers are UV-stabilized and impact-resistant frosted virgin acrylic, 1/8" thick. They are either angled toward the center optic or parallel to the ceiling plane. The standard center rails are approximately 9/16" wide. Optional narrow rails are approximately 5/16" wide.

**DOUBLE DIFFUSE:** Visible diffuser: UV-stabilized and impact-resistant frosted virgin acrylic, 1/8" thick. Inner diffuser: 1/8" thick with 60% round perforations white/white.

**DOOR STYLE:** *Curved Slotted (CS)* includes perforated rails that slope inward and a diffuse frosted acrylic center optic.

**CENTER OPTIC OPTIONS:** Only available with Angled (A), Angled Narrow Rail (ANR) and Flat (F) door styles.

*Diffuse Center Optic (DCO):* UV-stabilized and impact resistant frosted virgin acrylic.

*Slotted Center Optic (SCO):* Die-formed cold-rolled steel panel with a 1/16" x 1/2" rectangular hole pattern. Virgin acrylic overlay.

*Round Center Optic (RCO):* Die-formed cold-rolled steel panel with precision-punched 3/32" round hole pattern arranged in staggered formation. Virgin acrylic overlay.

**LIGHT OUTPUT:** Available in Boosted Standard (B). A separate chart summarizes lumen distribution and wattage. Light engines are replaceable.

**LUMEN MAINTENANCE:** 90% of initial light output (L90) at 100,000+ hours; 70% of initial light output (L70) at 200,000+ hours.

**TUNABLE WHITE DRIVER:** Replaceable LED driver accessible from below the ceiling. 120/277V. Power factor: ≥0.90. Total Harmonic Distortion (THD): <20%. Dimming Range: 100% - 1%. Expected driver lifetime: 100,000 hours.

**LUTRON DRIVER OPTIONS:** LutDTW (1% T-Series 2-Channel Digital Tunable White (PSQ Series)).

**ELECTRICAL:**

Emergency Option DMX: Battery backup only.

Emergency Option DALI: Battery backup, emergency-to-generator/ inverter wiring.

Emergency Option Lutron: Battery backup, emergency-to-generator/ inverter wiring.

Emergency Option PoE: Contact factory.

Battery Backup: Factory-choice low-profile backup battery available. Backup batteries deliver 1700 lumens. One quarter of the 1x4 will be illuminated in emergency mode. Backup battery will operate at 6500K in emergency.

Chicago Plenum: Available on request.

**MOUNTING:** Standard flange design works with most lay-in ceiling types. Integral pry-out tabs secure the luminaire to the ceiling grid from above. Tie-in locations for tie-wire on all corners. Consult local code for

appropriate tie-wire recommendations. Drywall and Surface Mount versions available; refer to separate tech sheets.

**DMX INTERCONNECTION CABLES:** Luminaires are prewired with plug-and-play interconnection cables to support easy plug-together joining of luminaire runs. If a non-FineTune DMX system has been specified, a DMX to RJ45 converter is provided.

**FINISHES:** Housing and door assembly painted with 96LG high reflectance matte white powder coat paint. Optional adder: Anti-microbial paint. Contact factory.

**FEED:** Standard with one 18-gauge single-circuit feed. 14-gauge feed available on request. DMX and power feed at same location (standard). Optional whips (with flex connectors) supplied in a maximum of 11' lengths. Lead Wires. DMX feeds cannot be cut or spliced. DMX feeds should be ordered based on fixed lengths.

**LABELS:** Luminaire and electrical components are ETL-listed conforming to UL 916, 1598, 8750, 924 in the U.S.A. and CAN/CSA C22.2 No. 205, 250, and 141 in Canada. In accordance with NEC Code 410.73 (G), this luminaire contains an internal driver disconnect. Damp Location. IC-rated. Finelite products use electronic components that are RoHS compliant, and the mechanical components of the luminaire have been verified to not knowingly contain any restricted substances listed per RoHS Directive 2011/65/EU.

**WEIGHT:** 25 lbs maximum.

**WARRANTY:** 10-year performance-based warranty on all standard components. Qualified drivers by others and optional accessories such as emergency battery packs are covered by their individual manufacturer warranties.

**TUNABLE WHITE PRE-QUALIFIED DRIVERS BY OTHERS**

DMX	DALI	POE set up	LUTRON
EldoLED	EldoLED, Crestron	Contact Factory	LUTRON

NOTE: For a complete list of system option/limitations [please click here](#).