

FINELITE

High Performance 2" Aperture (HP-2) - Indirect/Direct



Date

Project

Type

Comments

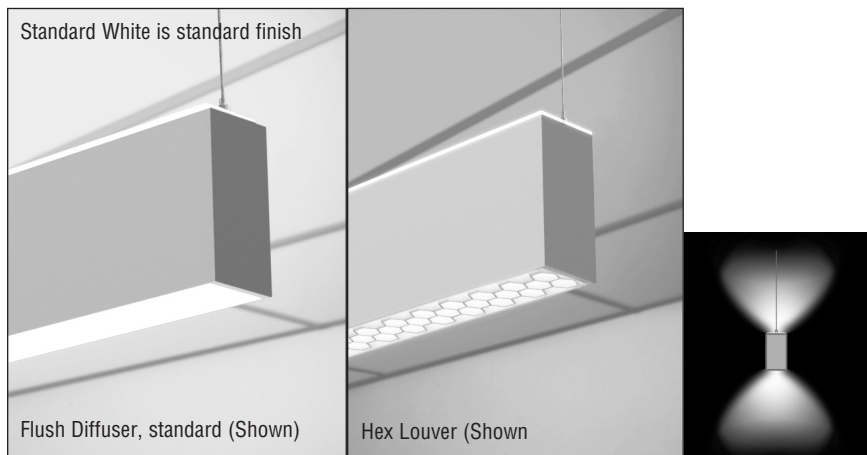

DESCRIPTION

High Performance 2" aperture Indirect/Direct (HP-2 ID) is a patented, linear LED luminaire that offers many aesthetic options including Top Glow™ or Flush for uplight and Bottom Glow™, 1" Drop Down Lens, Flush, White Cross Blade Baffle, Hollowed Ellipse Louver, Hex Louver, or Regressed diffuser for downlight. HP-2 ID delivers excellent performance using an advanced optical design and mid-power LEDs to achieve 90% of initial light output at 100,000+ hours.

ORDERING GUIDE: Sample Number: HP-2 ID - 32' - S - H - 835 - TG - F - 96LG - 120V - FA - FE - SC - C1 - OBO

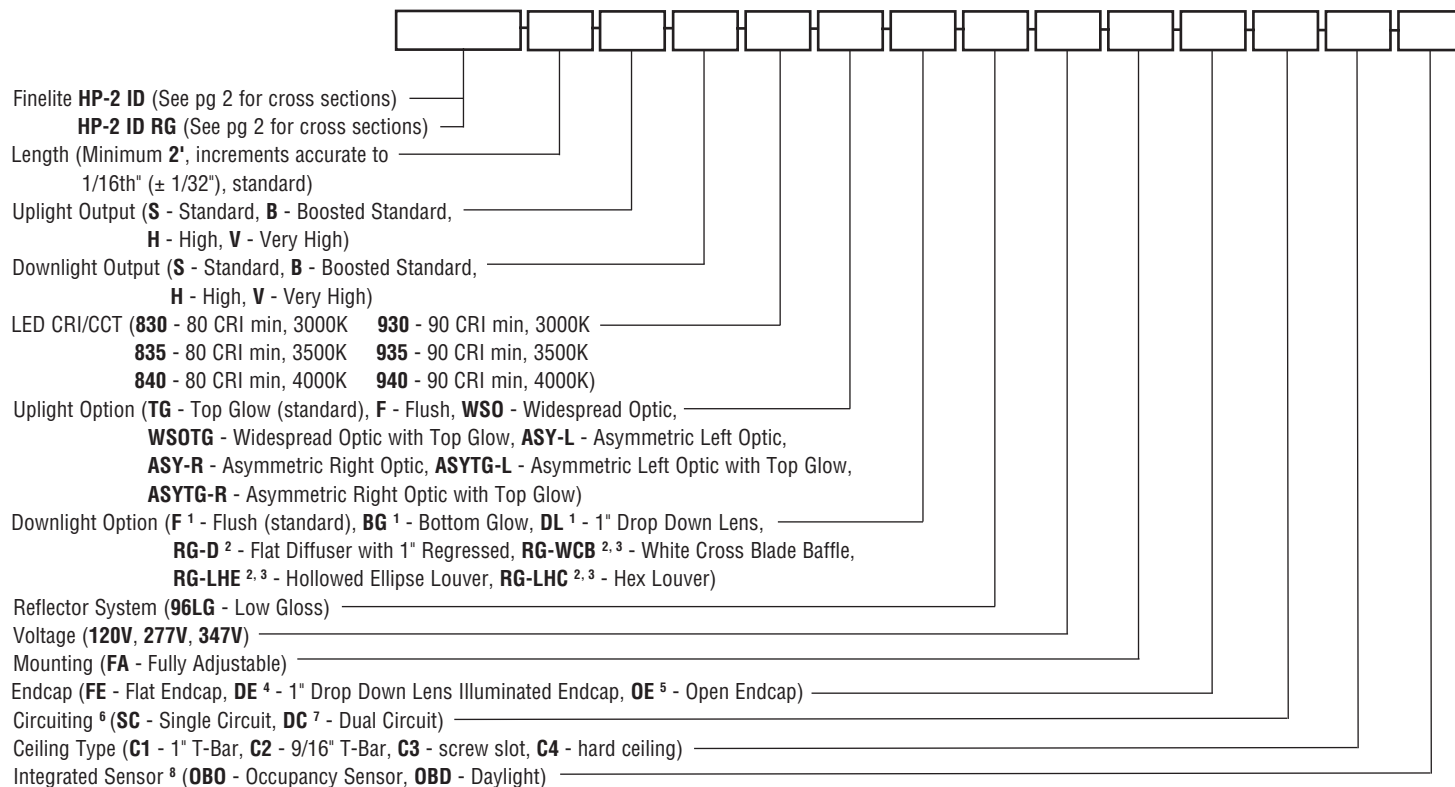

² Available for HP-2 Indirect/Direct (HP-2 ID) only
³ Available for HP-2 Indirect/Direct Regressed (HP-2 ID RG) only
⁴ Available in 1" increments
⁵ Available for 1" Drop Down Lens (DL) downlight option only

⁶ Available with Hollowed Ellipse Louver (LHE) only
⁷ DC only available for luminaires 3' or longer
⁸ Available with Flush (F), Bottom Glow (BG), White Cross Blade Baffle (WCB), and Regressed (RG) downlight diffusers

Protected by one or more US Patents: 8915613; D702,391; D702,390; D700,732; D727,554 S; D727,550 S, D727,551 S

A brand of **legrand**

Finelite, Inc. • 30500 Whipple Road • Union City, CA 94587-1530 • (510) 441-1100 • Fax: (510) 441-1510 • www.finelite.com

FINELITE

High Performance 2" Aperture (HP-2) - Indirect/Direct

AESTHETIC OPTIONS

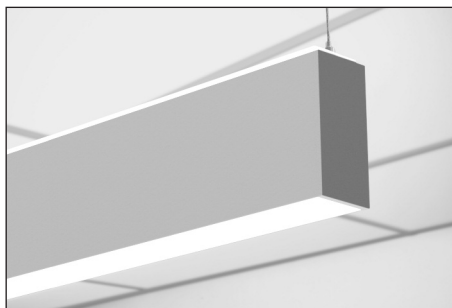

Top Glow and Flush Downlight Diffuser (TG/F)

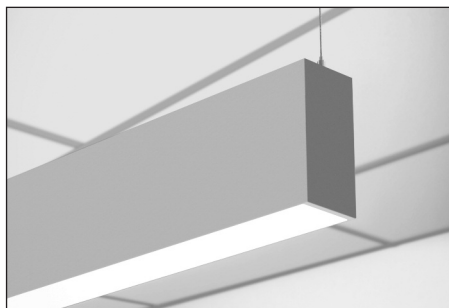

Flush Uplight and Downlight Diffuser (F/F)

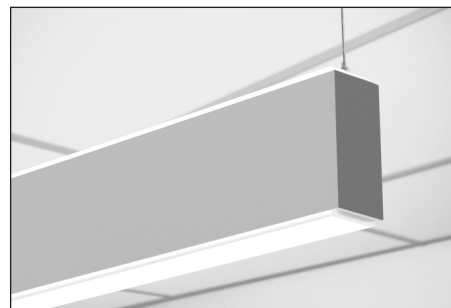

Top Glow and Bottom Glow Diffuser (TG/BG)

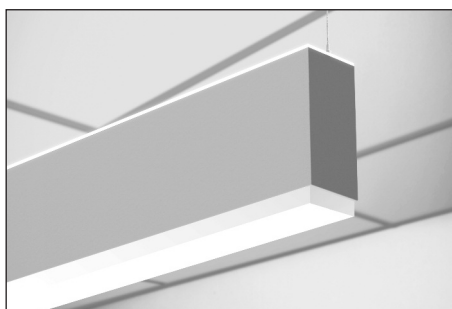

Top Glow and 1" Drop Down Lens (TG/DL)

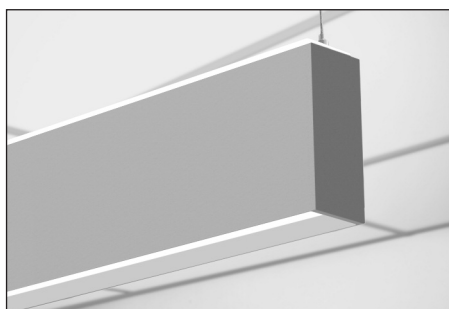

Top Glow and 1" Regressed Lens (TG/RG)

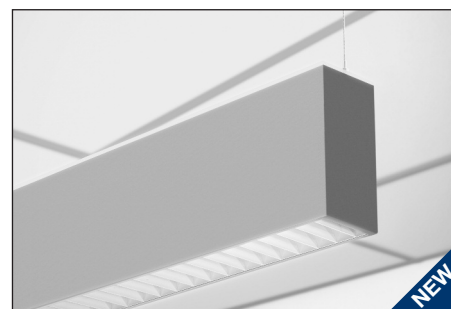

Top Glow and White Cross Blade Baffle (TG/RG-WCB)

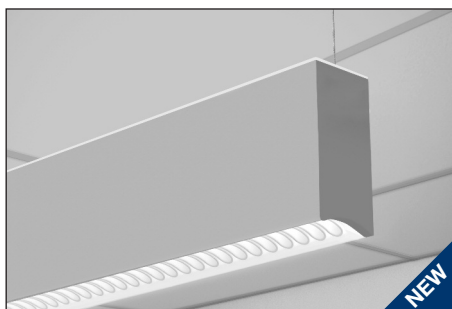

Top Glow and Hollowed Ellipse Louver (TG/RG-LHE)

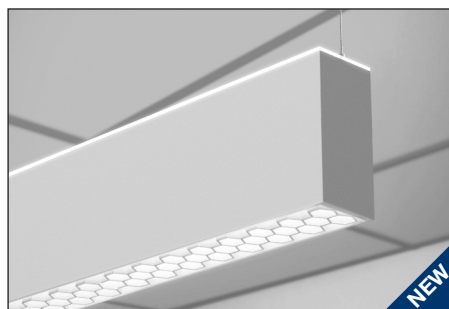

Top Glow and Hex Louver (TG/RG-LHC)

FINELITE

High Performance 2" Aperture (HP-2) - Indirect/Direct

OPTICAL SOLUTIONS AND AESTHETIC CHOICES - Offering multiple uplight optical solutions with WSO and ASY for maximized design effectiveness and diffusers available in Top Glow, Bottom Glow, 1" Drop Down Lens, Louvers, Flush, and Regressed for a desired aesthetic.

HP-2 ID

Top Glow Diffuser (Standard)

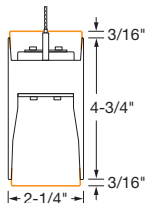

Flush Uplight Diffuser

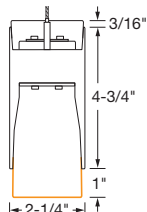

Widespread Optic with Top Glow

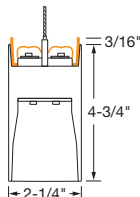

Widespread Optic

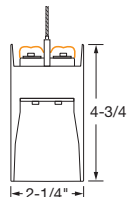

Asymmetric Optic with Top Glow (ASYTG-L Shown)

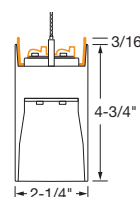

Asymmetric Optic (ASY-L Shown)

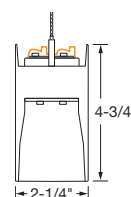

Bottom Glow Diffuser

1" Drop Down Lens

Flush Downlight Diffuser (Standard)

HP-2 ID RG

Top Glow Diffuser (Standard)

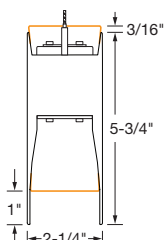

Flush Uplight Diffuser

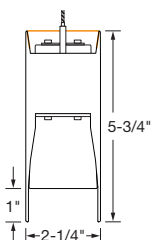

Top Glow Diffuser (Standard)

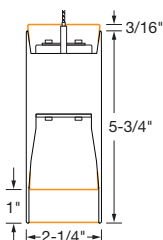

Widespread Optic with Top Glow

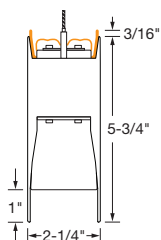

Widespread Optic

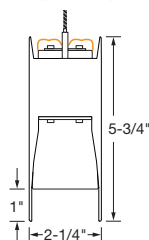

Asymmetric Optic with Top Glow (ASYTG-L Shown)

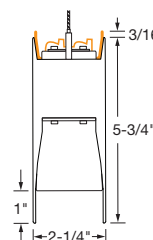

Asymmetric Optic (ASY-L Shown)

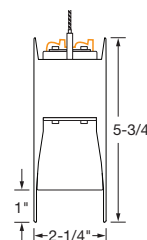

Flat Diffuser with 1" Regressed (Standard)

Louvers

ASYMMETRIC

Use this tool to understand how to specify Asymmetric for your project. The diagrams below show a linear run from power feed to ender. Specify: ASY-L distributed light to the left or ASY-R distributed light to the right.

Asymmetric Left Optic (ASY-L)

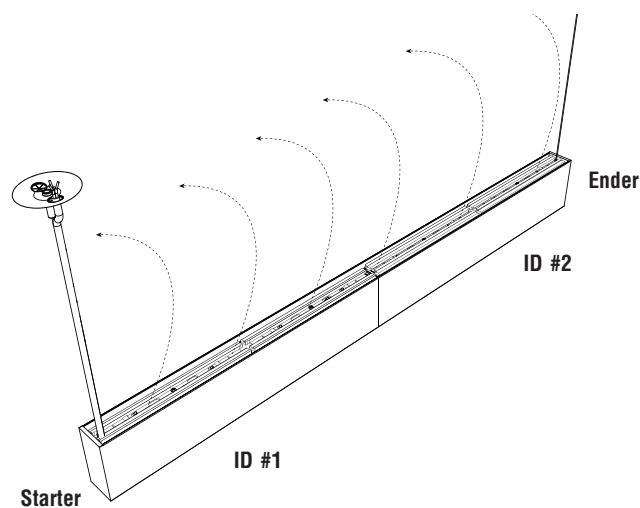

Asymmetric Right Optic (ASY-R)

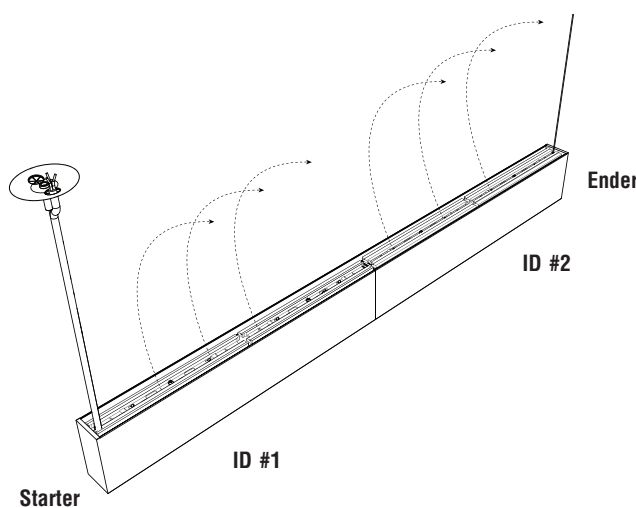

FINELITE

High Performance 2" Aperture (HP-2) - Indirect/Direct

PHOTOMETRY

UPLIGHT: FLUSH DIFFUSER

DOWNLIGHT: FLUSH DIFFUSER

HP-2-ID-V-V-835-F

Very High Output / Very High Output - 4' Luminaire

Distribution: 55% Up (V) / 45% Down (V)

Efficacy: 94 lumens per watt

Uplight: 3813 lumens (953 lumens/foot)

Downlight: 3175 lumens (794 lumens/foot)

Total luminaire output: 6988 lumens (1747 lumens/foot)

73.8 watts (18.5 watts/foot)

CRI: 80

CCT: 3500K

ITL LM79 Report 85132

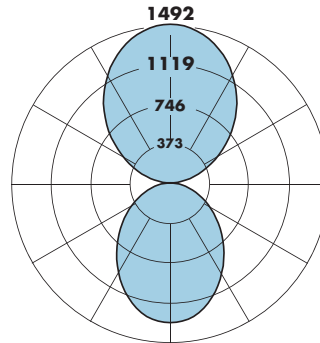

CANDELA DISTRIBUTION						
	0.0	22.5	45	67.5	90	Flux
0	1314	1314	1314	1314	1314	
5	1306	1307	1305	1304	1304	124
15	1241	1233	1231	1225	1220	346
25	1114	1098	1089	1076	1064	501
35	942	925	910	887	877	568
45	749	734	718	693	683	552
55	553	542	526	506	499	470
65	368	360	349	337	332	346
75	203	198	192	187	184	204
85	60	59	58	57	55	64
90	0	0	0	0	0	
95	71	68	68	69	70	77
105	244	241	236	235	234	252
115	442	439	437	427	425	431
125	661	649	653	643	638	581
135	884	871	875	866	866	673
145	1099	1084	1088	1084	1077	679
155	1283	1268	1275	1269	1263	585
165	1415	1405	1408	1406	1403	396
175	1482	1482	1482	1482	1481	141
180	1492	1492	1492	1492	1492	

↑ Indirect	↓ Direct
------------	----------

Total Light Output, 3500K, 80 CRI (Lumens) - 4' Luminaire				
	↑S*	↑B*	↑H*	↑V**
↓S*	2861 [↑55% 45%↓]	3262 [↑60% 40%↓]	4265 [↑70% 30%↓]	5113 [↑75% 25%↓]
↓B*	3195 [↑49% 51%↓]	3596 [↑55% 45%↓]	4600 [↑65% 35%↓]	5447 [↑70% 30%↓]
↓H*	4030 [↑39% 61%↓]	4432 [↑44% 56%↓]	5435 [↑55% 45%↓]	6282 [↑61% 39%↓]
↓V*	4736 [↑33% 67%↓]	5137 [↑38% 62%↓]	6141 [↑48% 52%↓]	6988 [↑55% 45%↓]

Lumen Adjustment Factors - 80 CRI	
3000K	0.985
3500K	1.000
4000K	1.032

Light Output, 3500K, 80 CRI (Lumens Per Foot)				
	↑S*	↑B*	↑H*	↑V**
↓S*	715	815	1066	1278
↓B*	799	899	1150	1362
↓H*	1008	1108	1359	1571
↓V*	1184	1284	1535	1747

Lumen Adjustment Factors - 90 CRI	
3000K	0.746
3500K	0.760
4000K	0.789

Apply a lumen adjustment factor to calculate lumens for the desired CCT and CRI.

Power, 3500K, 80 CRI (Watts Per Foot)				
	↑S*	↑B*	↑H*	↑V**
↓S*	7.2	8.2	10.7	12.8
↓B*	8.2	9.2	11.7	13.8
↓H*	10.7	11.7	14.2	16.3
↓V*	12.8	13.8	16.3	18.5

SAMPLE LUMEN ADJUSTMENT CALCULATION
 High Output (H) / Standard Output (S),
 4000K, 90CRI

$$\text{Lumen Adjustment Factor} = 0.789$$

$$\text{Total Light Output} = 4265 \text{ lm} \times 0.789 = 3365 \text{ lm}$$

$$\text{Total Light Output per Foot} = 1066 \text{ lm/ft} \times 0.789 = 841 \text{ lm/ft}$$

$$\text{watts/foot} = 10.7 \text{ W/ft}$$

$$\text{Efficacy} = \frac{841 \frac{\text{lm}}{\text{ft}}}{10.7 \frac{\text{W}}{\text{ft}}} = 78.6 \text{ lm/W}$$

Efficacy, 3500K, 80 CRI (Lumens Per Watt)				
	↑S*	↑B*	↑H*	↑V**
↓S*	99	99	100	100
↓B*	97	98	99	99
↓H*	94	95	96	96
↓V*	92	93	94	95

S - Standard Output, B - Boosted Standard Output, H - High Output, V - Very High Output

* Family Correlation based on 4' luminaire 3500K Very High Output (V) test - 120V.

** Based on ITL report: 85132

Protected by one or more US Patents: 8915613; D702,391; D702,390; D700,732; D727,554 S; D727,550 S, D727,551 S

A brand of LeGrand

Finelite, Inc. • 30500 Whipple Road • Union City, CA 94587-1530 • (510) 441-1100 • Fax: (510) 441-1510 • www.finelite.com

FINELITE

High Performance 2" Aperture (HP-2) - Indirect/Direct

PHOTOMETRY

UPLIGHT: FLUSH DIFFUSER

DOWNLIGHT: 1" DROP DOWN LENS

HP-2-ID-DL-V-V-835

Very High Output / Very High Output - 4' Luminaire

Distribution: 58% Up (V) / 42% Down (V)

Efficacy: 101 lumens per watt

Uplight: 4310 lumens (1078 lumens/foot)

Downlight: 3140 lumens (785 lumens/foot)

Total luminaire output: 7450 lumens (1863 lumens/foot)

73.8 watts (18.5 watts/foot)

CRI: 80

CCT: 3500K

ITL LM79 Report 85134

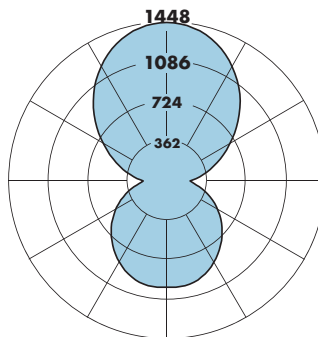

CANDELA DISTRIBUTION						
	0.0	22.5	45	67.5	90	Flux
0	969	969	969	969	969	
5	964	965	967	970	971	92
15	921	925	944	955	957	265
25	833	848	880	895	900	402
35	718	745	788	808	814	486
45	586	627	677	705	714	513
55	445	497	556	591	603	485
65	301	362	427	468	483	409
75	159	226	298	344	361	299
85	43	112	187	235	252	189
90	11	78	150	198	213	
95	82	146	214	257	271	217
105	254	304	363	398	412	370
115	446	486	538	563	573	520
125	656	682	727	748	757	641
135	871	882	923	939	945	705
145	1076	1076	1104	1121	1123	688
155	1250	1242	1263	1273	1273	580
165	1375	1368	1378	1380	1383	388
175	1439	1439	1439	1439	1439	137
180	1448	1448	1448	1448	1448	

↑ Indirect	↓ Direct
------------	----------

Total Light Output, 3500K, 80 CRI (Lumens) - 4' Luminaire

	↑S*	↑B*	↑H*	↑V**
↓S*	3050 [↑58% ↓42%↓]	3503 [↑63% ↓37%↓]	4638 [↑72% ↓28%↓]	5595 [↑77% ↓23%↓]
↓B*	3380 [↑52% ↓48%↓]	3834 [↑58% ↓42%↓]	4968 [↑68% ↓32%↓]	5926 [↑73% ↓27%↓]
↓H*	4207 [↑42% ↓58%↓]	4660 [↑48% ↓52%↓]	5794 [↑58% ↓42%↓]	6752 [↑64% ↓36%↓]
↓V*	4904 [↑36% ↓64%↓]	5358 [↑41% ↓59%↓]	6492 [↑52% ↓48%↓]	7450 [↑58% ↓42%↓]

Light Output, 3500K, 80 CRI (Lumens Per Foot)

	↑S*	↑B*	↑H*	↑V**
↓S*	762	876	1159	1399
↓B*	845	958	1242	1481
↓H*	1052	1165	1449	1688
↓V*	1226	1340	1623	1863

Power, 3500K, 80 CRI (Watts Per Foot)

	↑S*	↑B*	↑H*	↑V**
↓S*	7.2	8.2	10.7	12.8
↓B*	8.2	9.2	11.7	13.8
↓H*	10.7	11.7	14.2	16.3
↓V*	12.8	13.8	16.3	18.5

Efficacy, 3500K, 80 CRI (Lumens Per Watt)

	↑S*	↑B*	↑H*	↑V**
↓S*	106	107	108	109
↓B*	103	104	106	107
↓H*	98	100	102	104
↓V*	96	97	100	101

S - Standard Output, B - Boosted Standard Output, H - High Output, V - Very High Output

* Family Correlation based on 4' luminaire 3500K Very High Output (V) test - 120V.

** Based on ITL report: 85134

Lumen Adjustment Factors - 80 CRI	
3000K	0.985
3500K	1.000
4000K	1.032

Lumen Adjustment Factors - 90 CRI	
3000K	0.746
3500K	0.760
4000K	0.789

Apply a lumen adjustment factor to calculate lumens for the desired CCT and CRI.

SAMPLE LUMEN ADJUSTMENT CALCULATION

High Output (H) / Standard Output (S),
4000K, 90CRI

Lumen Adjustment Factor = 0.789

Total Light Output =
4638 lm x 0.789 = 3659 lm

Total Light Output per Foot =
1159 lm/ft x 0.789 = 914 lm/ft

watts/foot = 10.7 W/ft

$$\text{Efficacy} = \frac{914 \frac{\text{lm}}{\text{ft}}}{10.7 \frac{\text{W}}{\text{ft}}} = 85 \text{ lm/W}$$

FINELITE

High Performance 2" Aperture (HP-2) - Indirect/Direct

PHOTOMETRY

UPLIGHT: FLUSH DIFFUSER

DOWNLIGHT: REGRESSED DIFFUSER

HP-2-ID-RG-V-V-835-F

Very High Output / Very High Output - 4' Luminaire

Distribution: 59% Up (V) / 41% Down (V)

Efficacy: 99 lumens per watt

Uplight: 4304 lumens (1076 lumens/foot)

Downlight: 2928 lumens (732 lumens/foot)

Total luminaire output: 7232 lumens (1808 lumens/foot)
73.2 watts (18.3 watts/foot)

CRI: 80

CCT: 3500K

ITL LM79 Report 90352

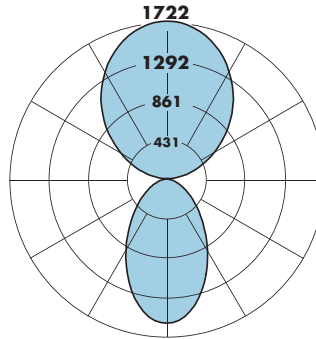

CANDELA DISTRIBUTION						
	0.0	22.5	45.0	67.5	90.0	FLUX
0	1585	1585	1585	1585	1585	1585
5	1573	1571	1564	1558	1556	147
15	1492	1459	1411	1364	1342	396
25	1334	1260	1157	1068	1034	536
35	1118	1013	875	770	730	560
45	872	758	613	516	483	495
55	631	517	391	324	303	381
65	403	307	218	178	173	248
75	206	138	103	96	94	130
85	48	30	26	25	24	34
90	0	0	0	0	0	0
95	69	69	69	66	64	76
105	251	250	250	249	247	265
115	478	474	476	471	470	470
125	734	726	728	723	721	650
135	1000	990	994	990	982	765
145	1265	1245	1253	1248	1238	781
155	1482	1463	1476	1467	1460	676
165	1635	1623	1630	1626	1621	458
175	1712	1711	1711	1710	1709	162
180	1722	1722	1722	1722	1722	

↑ Indirect ↓ Direct

Total Light Output, 3500K, 80 CRI (Lumens) - 4' Luminaire				
	↑S*	↑B*	↑H*	↑V**
↓S*	2960 [↑60% 40%↓]	3414 [↑65% 35%↓]	4546 [↑74% 26%↓]	5503 [↑78% 22%↓]
↓B*	3269 [↑54% 46%↓]	3722 [↑60% 40%↓]	4854 [↑69% 31%↓]	5811 [↑74% 26%↓]
↓H*	4039 [↑44% 56%↓]	4492 [↑49% 51%↓]	5625 [↑60% 40%↓]	6581 [↑65% 35%↓]
↓V*	4690 [↑38% 62%↓]	5143 [↑43% 57%↓]	6276 [↑53% 47%↓]	7232 [↑59% 41%↓]

Lumen Adjustment Factors - 80 CRI	
3000K	0.985
3500K	1.000
4000K	1.032

Light Output, 3500K, 80 CRI (Lumens Per Foot)				
	↑S*	↑B*	↑H*	↑V**
↓S*	740	853	1137	1376
↓B*	817	930	1214	1453
↓H*	1010	1123	1406	1645
↓V*	1172	1286	1569	1808

Lumen Adjustment Factors - 90 CRI	
3000K	0.746
3500K	0.760
4000K	0.789

Apply a lumen adjustment factor to calculate lumens for the desired CCT and CRI.

Power, 3500K, 80 CRI (Watts Per Foot)				
	↑S*	↑B*	↑H*	↑V**
↓S*	7.2	8.1	10.6	12.7
↓B*	8.1	9.1	11.6	13.7
↓H*	10.6	11.6	14.0	16.2
↓V*	12.7	13.7	16.2	18.3

SAMPLE LUMEN ADJUSTMENT CALCULATION
High Output (H) / Standard Output (S),
4000K, 90CRI

$$\text{Lumen Adjustment Factor} = 0.789$$

$$\text{Total Light Output} = 4546 \text{ lm} \times 0.789 = 3587 \text{ lm}$$

$$\text{Total Light Output per Foot} = 1137 \text{ lm/ft} \times 0.789 = 897 \text{ lm/ft}$$

$$\text{watts/foot} = 10.6 \text{ W/ft}$$

$$\text{Efficacy} = \frac{897 \frac{\text{lm}}{\text{ft}}}{10.6 \frac{\text{W}}{\text{ft}}} = 85 \text{ lm/W}$$

Efficacy, 3500K, 80 CRI (Lumens Per Watt)				
	↑S*	↑B*	↑H*	↑V**
↓S*	103	105	107	108
↓B*	100	102	105	106
↓H*	95	97	100	102
↓V*	92	94	97	99

S - Standard Output, B - Boosted Standard Output, H - High Output, V - Very High Output

* Family Correlation based on 4' luminaire 3500K Very High Output (V) test - 120V.

** Based on ITL report: 90352

FINELITE

High Performance 2" Aperture (HP-2) - Indirect/Direct

PHOTOMETRY

UPLIGHT: WIDESPREAD OPTIC
DOWNLIGHT: FLUSH DIFFUSER

HP-2-ID-V-V-835-WSO

Very High Output / Very High Output - 4' Luminaire

Distribution: 55% Up (V) / 45% Down (V)

Efficacy: 101 lumens per watt

Uplight: 4018 lumens (1005 lumens/foot)

Downlight: 3312 lumens (828 lumens/foot)

Total luminaire output: 7330 lumens (1833 lumens/foot)

72.5 watts (18.1 watts/foot)

Peak Candela (Uplight): 1457 @ 135°

CRI: 80

CCT: 3500K

ITL LM79 Report 89456

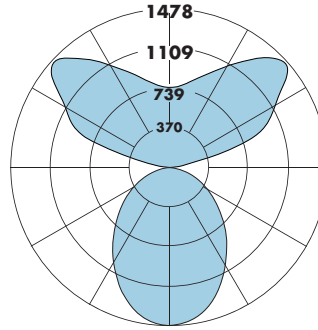

CANDELA DISTRIBUTION						
	0.0	22.5	45	67.5	90	Flux
0	1461	1461	1461	1461	1461	
5	1451	1450	1448	1447	1447	137
15	1376	1362	1359	1348	1342	381
25	1224	1204	1187	1165	1153	545
35	1023	998	973	942	929	608
45	794	773	749	717	705	576
55	568	557	535	509	499	478
65	364	356	344	328	322	341
75	187	186	180	174	170	191
85	49	49	48	46	45	54
90	0	0	0	0	0	
95	47	83	83	69	68	92
105	183	258	532	556	458	434
115	324	409	720	993	1048	694
125	460	542	887	1257	1299	793
135	558	634	907	1299	1457	741
145	633	693	885	1127	1236	572
155	694	728	843	963	1012	393
165	736	749	793	837	853	226
175	756	758	763	768	770	73
180	759	759	759	759	759	

↑ Indirect	↓ Direct
------------	----------

Total Light Output, 3500K, 80 CRI (Lumens) - 4' Luminaire				
	↑S*	↑B*	↑H*	↑V**
↓S*	3001 [↑55% 45%↓]	3424 [↑60% 40%↓]	4481 [↑70% 30%↓]	5374 [↑75% 25%↓]
↓B*	3349 [↑49% 51%↓]	3772 [↑55% 45%↓]	4830 [↑65% 35%↓]	5722 [↑70% 30%↓]
↓H*	4221 [↑39% 61%↓]	4644 [↑44% 56%↓]	5701 [↑55% 45%↓]	6594 [↑61% 39%↓]
↓V*	4957 [↑33% 67%↓]	5380 [↑38% 62%↓]	6437 [↑48% 52%↓]	7330 [↑55% 45%↓]

Lumen Adjustment Factors - 80 CRI	
3000K	0.985
3500K	1.000
4000K	1.032

Light Output, 3500K, 80 CRI (Lumens Per Foot)				
	↑S*	↑B*	↑H*	↑V**
↓S*	750	856	1120	1343
↓B*	837	943	1207	1431
↓H*	1055	1161	1425	1649
↓V*	1239	1345	1609	1833

Lumen Adjustment Factors - 90 CRI	
3000K	0.746
3500K	0.760
4000K	0.789

Apply a lumen adjustment factor to calculate lumens for the desired CCT and CRI.

Power, 3500K, 80 CRI (Watts Per Foot)				
	↑S*	↑B*	↑H*	↑V**
↓S*	7.1	8.1	10.5	12.6
↓B*	8.1	9.0	11.5	13.6
↓H*	10.5	11.5	13.9	16.0
↓V*	12.6	13.6	16.0	18.1

SAMPLE LUMEN ADJUSTMENT CALCULATION
High Output (H) / Standard Output (S),
4000K, 90CRI

$$\text{Lumen Adjustment Factor} = 0.789$$

$$\text{Total Light Output} = 4481 \text{ lm} \times 0.789 = 3536 \text{ lm}$$

$$\text{Total Light Output per Foot} = 1120 \text{ lm/ft} \times 0.789 = 884 \text{ lm/ft}$$

$$\text{watts/foot} = 10.5 \text{ W/ft}$$

$$\text{Efficacy} = \frac{884 \frac{\text{lm}}{\text{ft}}}{10.5 \frac{\text{W}}{\text{ft}}} = 84 \text{ lm/W}$$

Efficacy, 3500K, 80 CRI (Lumens Per Watt)				
	↑S*	↑B*	↑H*	↑V**
↓S*	106	106	107	107
↓B*	104	105	105	105
↓H*	100	101	102	103
↓V*	98	99	100	101

S - Standard Output, B - Boosted Standard Output, H - High Output, V - Very High Output

* Family Correlation based on 4' luminaire 3500K Very High Output (V) test - 120V.

** Based on ITL report: 89456

FINELITE

High Performance 2" Aperture (HP-2) - Indirect/Direct

PHOTOMETRY

UPLIGHT: ASYMMETRIC OPTIC
DOWNLIGHT: FLUSH DIFFUSER

HP-2-ID-V-V-835-ASY-R

Very High Output / Very High Output - 4' Luminaire

Distribution: 57% Up (V) / 43% Down (V)

Efficacy: 102 lumens per watt

Uplight: 4301 lumens (1075 lumens/foot)

Downlight: 3184 lumens (796 lumens/foot)

Total Luminaire Output: 7485 lumens (1871 lumens/foot)
73.5 watts (18.4 watts/foot)

CRI: 80

CCT: 3500K

ITL LM79 Report 89599

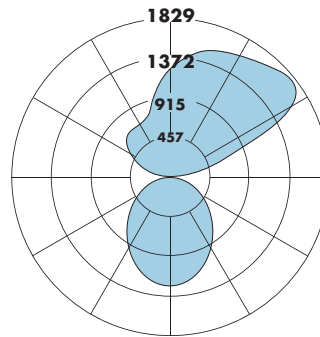

CANDELA DISTRIBUTION						
	0.0	45.0	90.0	135.0	180.0	Flux
0	1247	1247	1247	1247	1247	
5	1238	1239	1239	1239	1238	117
15	1165	1173	1187	1177	1167	331
25	1034	1048	1067	1053	1036	484
35	873	894	914	897	873	559
45	701	720	738	720	697	554
55	526	541	557	539	524	483
65	359	368	379	366	355	363
75	210	207	209	203	199	218
85	72	68	61	63	63	75
90	36	23	0	20	27	
95	156	143	59	82	79	121
105	513	615	209	253	262	397
115	1389	1126	367	406	439	684
125	1821	1266	532	519	597	785
135	1760	1310	699	591	689	738
145	1654	1364	868	650	691	636
155	1583	1408	1027	735	702	498
165	1493	1379	1149	925	836	326
175	1318	1285	1214	1143	1108	115
180	1222	1222	1222	1222	1222	

↑ Indirect ↓ Direct

Total Light Output, 3500K, 80 CRI (Lumens) - 4' Luminaire				
	↑S*	↑B*	↑H*	↑V**
↓S*	3064 [↑58% ↓42%↓]	3517 [↑63% ↓37%↓]	4649 [↑72% ↓28%↓]	5604 [↑77% ↓23%↓]
↓B*	3399 [↑52% ↓48%↓]	3852 [↑58% ↓42%↓]	4984 [↑67% ↓33%↓]	5940 [↑72% ↓28%↓]
↓H*	4237 [↑42% ↓58%↓]	4690 [↑47% ↓53%↓]	5822 [↑58% ↓42%↓]	6777 [↑64% ↓36%↓]
↓V*	4945 [↑36% ↓64%↓]	5397 [↑41% ↓59%↓]	6529 [↑51% ↓49%↓]	7485 [↑57% ↓43%↓]

Lumen Adjustment Factors - 80 CRI	
3000K	0.985
3500K	1.000
4000K	1.032

Light Output, 3500K, 80 CRI (Lumens Per Foot)				
	↑S*	↑B*	↑H*	↑V**
↓S*	766	879	1162	1401
↓B*	850	963	1246	1485
↓H*	1059	1172	1455	1694
↓V*	1236	1349	1632	1871

Lumen Adjustment Factors - 90 CRI	
3000K	0.746
3500K	0.760
4000K	0.789

Apply a lumen adjustment factor to calculate lumens for the desired CCT and CRI.

SAMPLE LUMEN ADJUSTMENT CALCULATION

High Output (H) / Standard Output (S),
4000K, 90CRI

$$\text{Lumen Adjustment Factor} = 0.789$$

$$\text{Total Light Output} = 4649 \text{ lm} \times 0.789 = 3668 \text{ lm}$$

$$\text{Total Light Output per Foot} = 1162 \text{ lm/ft} \times 0.789 = 917 \text{ lm/ft}$$

$$\text{watts/foot} = 10.6 \text{ W/ft}$$

$$\text{Efficacy} = \frac{1106 \frac{\text{lm}}{\text{ft}}}{10.6 \frac{\text{W}}{\text{ft}}} = 87 \text{ lm/W}$$

Power, 3500K, 80 CRI (Watts Per Foot)				
	↑S*	↑B*	↑H*	↑V**
↓S*	7.2	8.2	10.6	12.8
↓B*	8.2	9.1	11.6	13.8
↓H*	10.6	11.6	14.1	16.2
↓V*	12.8	13.8	16.2	18.4

Efficacy, 3500K, 80 CRI (Lumens Per Watt)				
	↑S*	↑B*	↑H*	↑V**
↓S*	106	108	109	110
↓B*	104	105	107	108
↓H*	100	101	103	104
↓V*	97	98	101	102

S - Standard Output, B - Boosted Standard Output, H - High Output, V - Very High Output

* Family Correlation based on 4' luminaire 3500K Very High Output (V) test - 120V.

** Based on ITL report: 89599

Protected by one or more US Patents: 8915613; D702,391; D702,390; D700,732; D727,554 S; D727,550 S, D727,551 S

A brand of Legrand

Finelite, Inc. • 30500 Whipple Road • Union City, CA 94587-1530 • (510) 441-1100 • Fax: (510) 441-1510 • www.finelite.com

FINELITE

High Performance 2" Aperture (HP-2) - Indirect/Direct

PHOTOMETRY

UPLIGHT: TOP GLOW DIFFUSER

DOWNLIGHT: WHITE CROSS BLADE BAFFLE

HP-2-ID-V-V-835-TG

Very High Output / Very High Output - 4' Luminaire

Distribution: 64% Up (V) / 36% Down (V)

Efficacy: 81 lumens per watt

Uplight: 3813 lumens (953 lumens/foot)

Downlight: 2169 lumens (542 lumens/foot)

Total luminaire output: 5982 lumens (1496 lumens/foot)

81.2 watts (20.3 watts/foot)

CRI: 80

CCT: 3500K

ITL LM79 Report Based Upon

85132 (UP) / 91551 (Down)

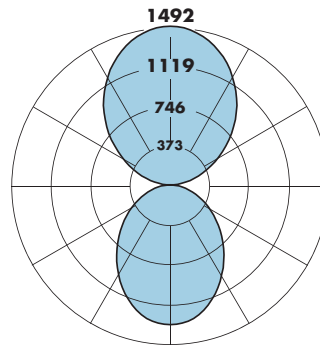

CANDELA DISTRIBUTION						
	0.0	22.5	45	67.5	90	Flux
0	1276	1276	1276	1276	1276	
5	1245	1250	1259	1269	1273	119
15	1076	1088	1135	1186	1209	319
25	850	869	931	982	1019	426
35	609	633	680	735	783	428
45	371	395	452	506	547	351
55	250	251	270	307	323	251
65	156	156	163	169	176	163
75	81	82	84	85	86	89
85	21	21	20	20	20	24
90	0	0	0	0	0	
95	71	68	68	69	70	77
105	244	241	236	235	234	252
115	442	439	437	427	425	431
125	661	649	653	643	638	581
135	884	871	875	866	866	673
145	1099	1084	1088	1084	1077	679
155	1283	1268	1275	1269	1263	585
165	1415	1405	1408	1406	1403	396
175	1482	1482	1482	1482	1481	141
180	1492	1492	1492	1492	1492	

↑ Indirect	↓ Direct
------------	----------

Total Light Output, 3500K, 80 CRI (Lumens) - 4' Luminaire				
	↑S*	↑B*	↑H*	↑V**
↓S*	2449 [↑64% 36%↓]	2850 [↑69% 31%↓]	3854 [↑77% 23%↓]	4701 [↑81% 19%↓]
↓B*	2677 [↑58% 42%↓]	3078 [↑64% 36%↓]	4082 [↑73% 27%↓]	4929 [↑77% 23%↓]
↓H*	3248 [↑48% 52%↓]	3649 [↑54% 46%↓]	4653 [↑64% 36%↓]	5500 [↑69% 31%↓]
↓V*	3730 [↑42% 58%↓]	4131 [↑47% 53%↓]	5135 [↑58% 42%↓]	5982 [↑64% 36%↓]

Lumen Adjustment Factors - 80 CRI	
3000K	0.985
3500K	1.000
4000K	1.032

Light Output, 3500K, 80 CRI (Lumens Per Foot)				
	↑S*	↑B*	↑H*	↑V**
↓S*	612	713	963	1175
↓B*	669	770	1020	1232
↓H*	812	912	1163	1375
↓V*	932	1033	1284	1496

Lumen Adjustment Factors - 90 CRI	
3000K	0.746
3500K	0.760
4000K	0.789

Apply a lumen adjustment factor to calculate lumens for the desired CCT and CRI.

Power, 3500K, 80 CRI (Watts Per Foot)				
	↑S*	↑B*	↑H*	↑V**
↓S*	7.9	9.0	11.8	14.1
↓B*	9.0	10.1	12.8	15.2
↓H*	11.8	12.8	15.6	17.9
↓V*	14.1	15.2	17.9	20.3

SAMPLE LUMEN ADJUSTMENT CALCULATION

High Output (H) / Standard Output (S),
4000K, 90CRI

$$\text{Lumen Adjustment Factor} = 0.789$$

$$\text{Total Light Output} = 3854 \text{ lm} \times 0.789 = 3041 \text{ lm}$$

$$\text{Total Light Output per Foot} = 963 \text{ lm/ft} \times 0.789 = 760 \text{ lm/ft}$$

$$\text{watts/foot} = 11.8 \text{ W/ft}$$

$$\text{Efficacy} = \frac{760 \frac{\text{lm}}{\text{ft}}}{11.8 \frac{\text{W}}{\text{ft}}} = 64 \text{ lm/W}$$

Efficacy, 3500K, 80 CRI (Lumens Per Watt)				
	↑S*	↑B*	↑H*	↑V**
↓S*	77	79	82	83
↓B*	74	76	80	81
↓H*	69	71	75	77
↓V*	66	68	72	74

S - Standard Output, B - Boosted Standard Output, H - High Output, V - Very High Output

* Family Correlation based on 4' luminaire 3500K Very High Output (V) test - 120V.

** Based on ITL report: 85132 (UP) / 91551 (DOWN)



FINELITE

High Performance 2" Aperture (HP-2) - Indirect/Direct

SPECIFICATIONS

CONSTRUCTION: Precision-cut 6061-T6 extruded aluminum body. Internal joiner system, plug-together wiring, standard.

ENDCAPS: Flat diecast aluminum endcaps add 1/4" to each end of luminaire. Drop Down Lens Illuminated Endcap (**DE**) includes diffuse element to continue luminance of drop lens. It is made of the same material as the drop diffuse. Open Endcap (**OE**) is for use with the Hollowed Ellipse Louver (**LHE**); following the curve of the louver.

MITERED CORNER¹: Illuminated 90° corners in a single plane, Flush downlight diffuser (standard), or White Cross Blade Baffle (optional). Custom angles are available (90° minimum on inside corners), contact factory. 90 degree corners not available with Hollowed Ellipse Louver (**LHE**) or Hex Louver (**LHC**).

REFLECTORS: Die-formed 24-gauge cold-rolled steel reflectors are finished in 96 LG high reflectance matte white powder coat paint.

UPLIGHT OPTION: Patented Top Glow frost white diffuser standard. 12 ft. maximum diffuser length. 73% transmissive, 99% diffusion. Internal secondary diffusers at corners ensure visually seamless, uniform, continuous illumination. Optional: Flush frost white snap-in diffuser, 73% transmissive, 99% diffusion; Widespread Optic (**WSO**) and Widespread Optic with Top Glow (**WSOTG**); **WSO** enables increased luminaire spacing with improved ceiling uniformity. Asymmetric optic directs light in a specific direction. **ASY-L** distributes light to the left, **ASY-R** distributed light to the right of the luminaire. See page 2.

DOWNLIGHT OPTION: 12' maximum diffuser length. Flush frost white snap-in diffuser standard, 73% transmissive, 99% diffusion. Internal secondary diffusers at corners ensure visually seamless, uniform, continuous illumination. Available with Flush (**F**), Bottom Glow (**BG**), 1" Drop Down Lens (**DL**), White Cross Blade Baffle (**WCB**), Hollowed Ellipse Louver (**LHE**), Hex Louver (**LHC**), and Regressed downlight diffusers (**RG**). 1" Drop Down Lens made of highly efficient acrylic. Available with a solid endcap or an endcap with a diffuse filler to continue the luminous aesthetic.

LIGHT OUTPUT: Four lumen packages available, Standard (**S**), Boosted Standard (**B**), High (**H**), and Very High (**V**). For lengths 3 feet and greater, the uplight and downlight can be specified with different lumen packages and dual controls. A separate chart summarizes lumen distribution and wattage. Light engines are replaceable.

LUMEN MAINTENANCE: 90% of initial light output (L90) at 100,000+ hours; 70% of initial light output (L70) at 200,000+ hours.

DRIVER: Replaceable 120V/277V and 347V Constant Current Reduction dimming driver standard. Can be wired dimming or non-dimming. 0-10V dimming controls with a range of 10%- 100%. Dimming to 1% available; consult factory. For lengths 3 feet and greater, separate dimming for uplight and downlight available. Driver is fully accessible from below the ceiling. Power Factor: ≥ 0.9 . Total Harmonic Distortion (THD) $< 20\%$. Expected driver lifetime: 100,000 hours. Dali driver also available; Contact factory.

LUTRON DRIVER OPTIONS: **LUTES1** (Hi-lume 1% EcoSystem with Soft-On, Fade to Black dimming (LDE1 series)); **LUTES5** (5-Series 5% EcoSystem (LDE5 Series)), **LUT2W** (Hi-lume 1% 2-wire, 120V forward phase dimming (LTEA series)); Contact factory for availability of discontinued Lutron drivers, L3DA-3-wire and L3DA EcoSystem.

ELECTRICAL: Optional emergency to generator/inverter wiring, internal generator transfer switch, nightlight wiring, step-dimming driver, backup battery. Factory-choice low-profile backup battery available. 12' minimum luminaire length for low profile battery pack. Backup batteries deliver 1000 lumens. Half of a 4' section will be illuminated in emergency mode.

INTEGRATED SENSORS: Integrated PIR (Passive Infrared) occupancy and/or daylight sensors available with Flush, Bottom Glow, White Cross Blade Baffle, and Regressed downlight diffusers. Single circuit: 2' minimum luminaire length. Dual circuit: 4' minimum luminaire length. Refer to Occupancy Sensor and Daylight Sensor tech sheets for more info.

MOUNTING: 50" Fully Adjustable (**FA**) plated steel aircraft cable with safety stop hardware standard. Contact factory for additional lengths up to 150".

FINISHES: Finelite Signal White powder coat standard. Optional Adders: 185 RAL colors.

FEED: Standard with one 18-gauge/5-conductor single-circuit feed controlling uplight and downlight together (power and dimming). Specify dual feeds for independent control of uplight and downlight. 14-gauge feed used when luminaire current exceeds 5 amps.

LENGTHS: Any length, 2-foot minimum, in increments down to 1/16" ($\pm 1/32$ "). 12-foot maximum section length. Select a minimum body length of 3' or greater when requiring dual circuiting or when uplight and downlight outputs differ. Hollowed Ellipse Louver (**LHE**), Hex Louver (**LHC**), and White Cross Blade Baffle (**WCB**) are available in 1' increments.

LABELS: Fixture and electrical components are ETL-listed conforming to UL 1598 in the U.S.A. and CAN/CSA C22.2 No. 250.0 in Canada. In accordance with NEC Code 410.130 (G), this luminaire contains an internal driver disconnect. Damp Location. Finelite products use electronic components that are RoHS compliant, and the mechanical components of the luminaire have been verified to not knowingly contain any restricted substances listed per RoHS Directive 2011/65/EU.

WEIGHT: 2.9 lb/ft.

WARRANTY: 10-year performance-based warranty on all standard components. Optional accessories such as emergency battery packs are covered by their individual manufacturer warranties.

¹ White Cross Blade (WCB) is not available with custom angles. Available in 90 degrees only