

FINELITE

E2 Indirect/Direct (E2-ID) Configuration



Declare.



Date

Project

Type

Comments

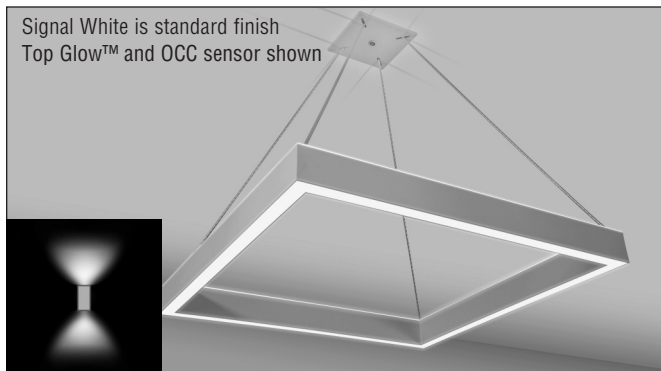

DESCRIPTION

E2 Indirect/Direct (E2-ID) Configuration provides excellent light output with a minimalist shape. Based on the Elements platform, E2 uses easy-to-install power supply boxes and power suspension cables that enable independent control of uplight and downlight. This Product is enrolled in the International Living Future Institute (ILFI) Declare 2.0 Program and is third-party verified with options achieving Declared status.

TOP GLOW DIFFUSER

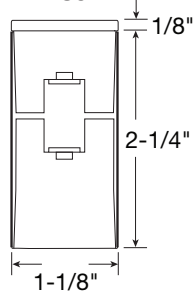

FLUSH DIFFUSER

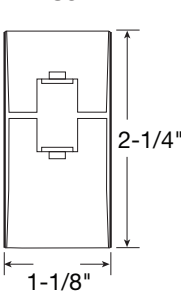

Low Profile T-Bar Power Supply Box (shown)

ELECTRICAL BOX OPTIONS

Various electrical boxes to meet application needs. Drivers easily accessible. See page 2 for more information.

STANDARD CONFIGURATIONS

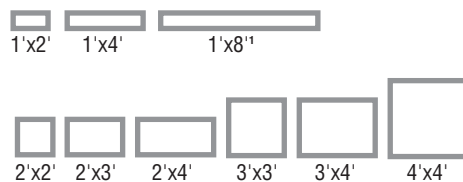

STANDARD CONFIGURATION DIMENSIONS

E2-ID configuration can be specified in various standard dimensions: 1'x2', 1'x4', 1'x8', 2'x2', 2'x3', 2'x4', 3'x3', 3'x4', and 4'x4'.

DIMENSIONS

Small form with glare-free illumination.

ORDERING GUIDE: Sample Number: E2-ID - C - 2'x2' - H - H - 835 - TG - F - 96LG - 120V - SC - APC - C1 - OBO - RLD

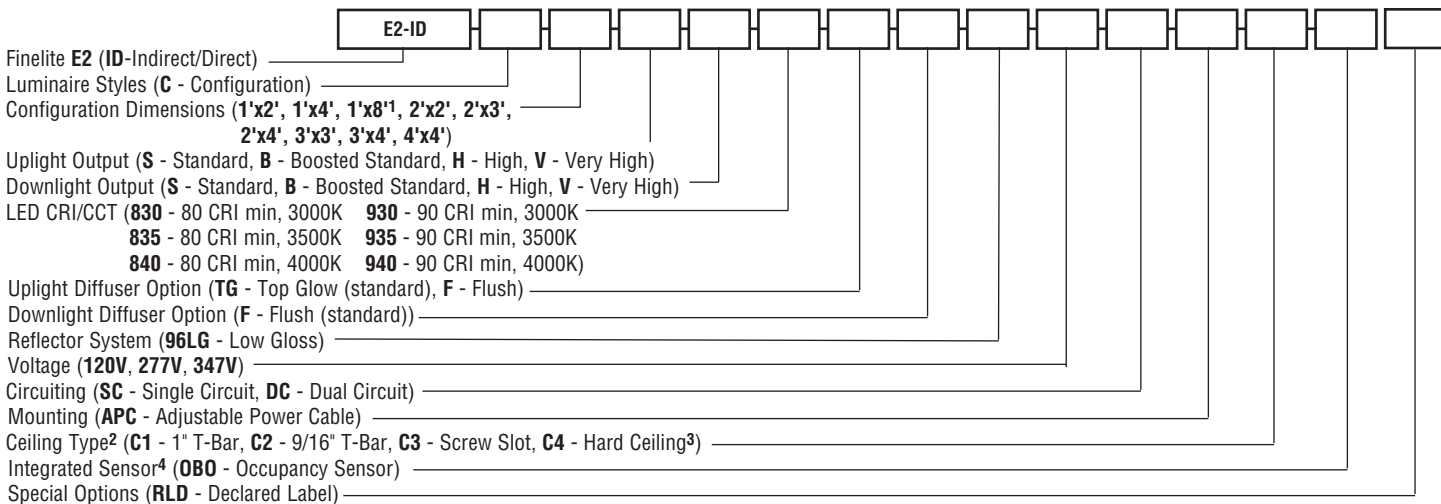

¹ 1'x8' is installed using two power supply boxes (one at each end of the luminaire). See page 4 for more information.

² E2-ID does not mount directly in alignment to T-Bar Grid / On-Grid.

³ C4 is used for sheetrock ceilings. Contact Factory for open ceiling applications.

⁴ Sensor is integrated into the canopy above the luminaire.

FINELITE

E2 Indirect/Direct (E2-ID) Configuration

ELECTRICAL BOX OPTIONS

E2 can be specified with power supply boxes to meet specific application needs. From new to retrofit, T-Bar to drywall, to fully remote, E2 power supply boxes install quickly and easily. Power supply boxes are IC Rated. Chicago Plenum available.

Low Profile T-Bar Power Supply Box (P01)

Dimensions: 10-1/8"W x 16-1/8"L x 1-11/16"D
Available: 1'x2', 1'x8", 2'x2'



- T-Bar only
- Two drivers maximum per box
- Includes easy leveling system from below ceiling
- Access drivers from above ceiling for simple maintenance
- (7) 1/2" feed knockouts available to connect building power
- Optional occupancy sensor located in canopy for a clean aesthetic

Large Capacity Power Supply Box (P02)

Dimensions: 10"W x 23"L x 4"D
Available: 1'x2', 1'x4', 1'x8", 2'x2', 2'x3', 2'x4', 3'x3', 3'x4', 4'x4'



- T-Bar or Drywall ceiling compatible²
- Four drivers maximum per box or two drivers and one EM battery pack (illuminates 4' only) for egress
- Includes easy leveling system from below the ceiling
- Access to drivers from below ceiling to reduce maintenance time
- (4) 1/2" feed knockouts available to connect building power
- Optional Occupancy sensor located in canopy for a clean aesthetic

Retrofit Power Supply Box (P03)

Dimensions: 5"W x 14-3/8"L x 8-3/4"D
Available: 1'x2', 2'x2'

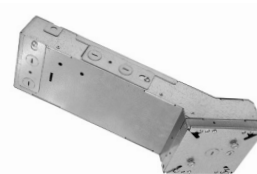

- T-Bar or Drywall ceiling compatible²
- Two drivers maximum per box
- Includes easy leveling system from below ceiling
- Access to drivers from below ceiling to reduce maintenance time
- (4) 1/2" feed knockouts available to connect building power
- Optional Occupancy sensor located in canopy for a clean aesthetic

Splice Box (S01)

Dimensions: 5"W x 5"L x 2-3/8"D

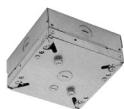

- T-Bar or Drywall ceiling compatible²
- Includes easy leveling system from below ceiling

Easy Leveling System On All Boxes

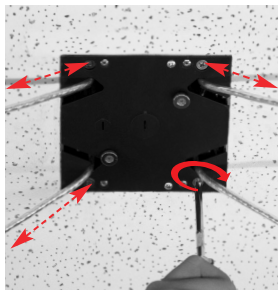

4 Leveling Screws

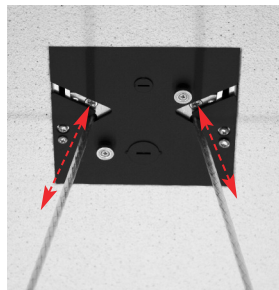

2 Leveling Screws (1x8 Only)

E2-ID Configuration includes a patent pending leveling system for simple individual suspension adjustment for a consistent luminaire sightline.

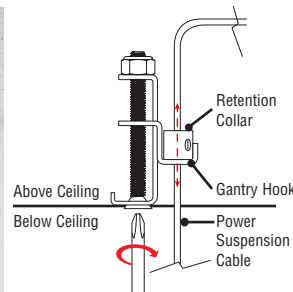

4 Leveling Screws



Scan this QR code with your mobile phone or tablet to watch video

¹ 1'x8" is installed using two power supply boxes (one at each end of the luminaire).

² Contact Factory for open ceiling applications.

FINELITE

E2 Indirect/Direct (E2-ID) Configuration

ELECTRICAL BOX SPECIFICATION (For more details, refer to www.finelite.com for the Electrical Box Specification Guide.)

**LOW PROFILE T-BAR
POWER SUPPLY BOXES (P01)**
(T-Bar Ceiling)

(Max 2 Drivers)
1'x2', 1'x8'¹, 2'x2'

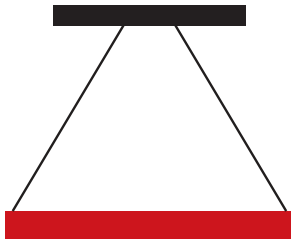

**RETROFIT
POWER SUPPLY BOXES (P03)**
(Drywall or T-Bar Ceiling)

(Max 2 Drivers)
1'x2', 2'x2'

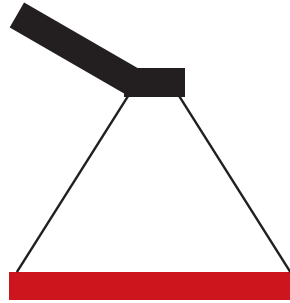

**LARGE CAPACITY
POWER SUPPLY BOXES (P02)**
(Drywall or T-Bar Ceiling)

(Max 4 Drivers or 2 Drivers and 1 EM)
1'x2', 1'x4', 1'x8'¹, 2'x2', 2'x3',
2'x4', 3'x3', 3'x4', 4'x4'

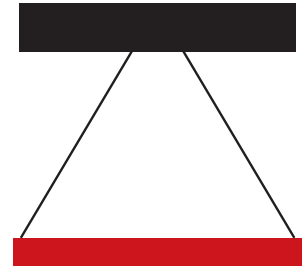

STANDARD CONFIGURATION DIMENSIONS (Drywall or T-Bar Ceiling)

To find actual dimensions for all configurations, add 1-1/8" to each section length.



1'x2'



1'x4'



1'x8'¹



2'x2'



2'x3'



2'x4'



3'x3'



3'x4'



4'x4'

¹ 1'x8' is installed using two power supply boxes (one at each end of the luminaire).

FINELITE

E2 Indirect/Direct (E2-ID) Configuration

EASY INSTALLATION

Specially designed mounting hardware and a unique canopy design makes E2 Configuration easy to install, level, and maintain. Designed to mount cleanly in the center of ceiling tile or sheetrock ceiling.

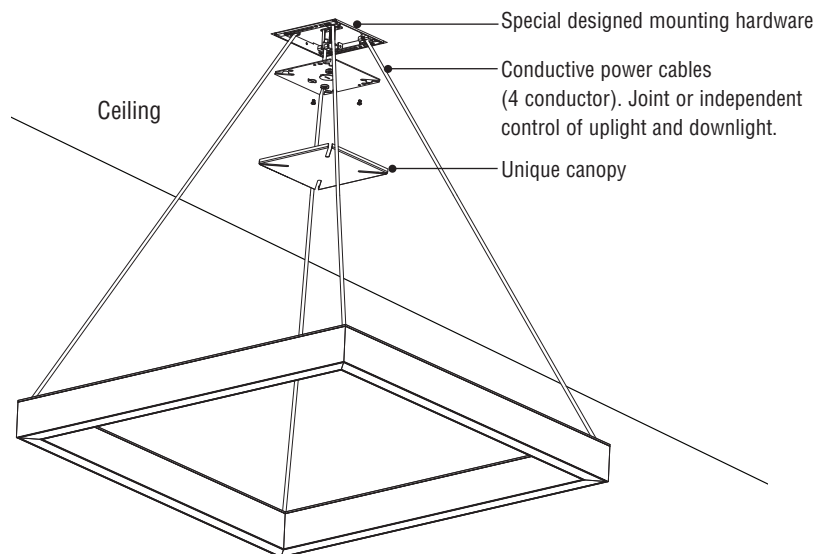

ROUGH-IN

T-Bar or Drywall

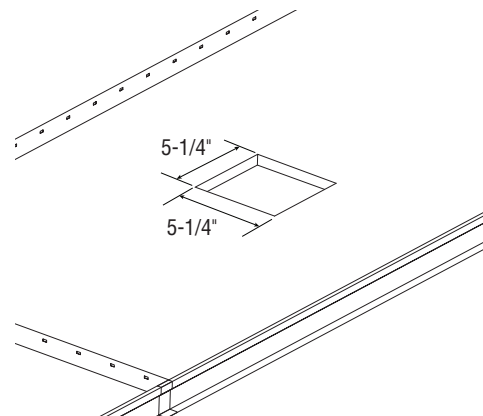

1'X8' INSTALLATION

The E2 1'x8' is installed using two power supply boxes (one at each end and directly above the luminaire).

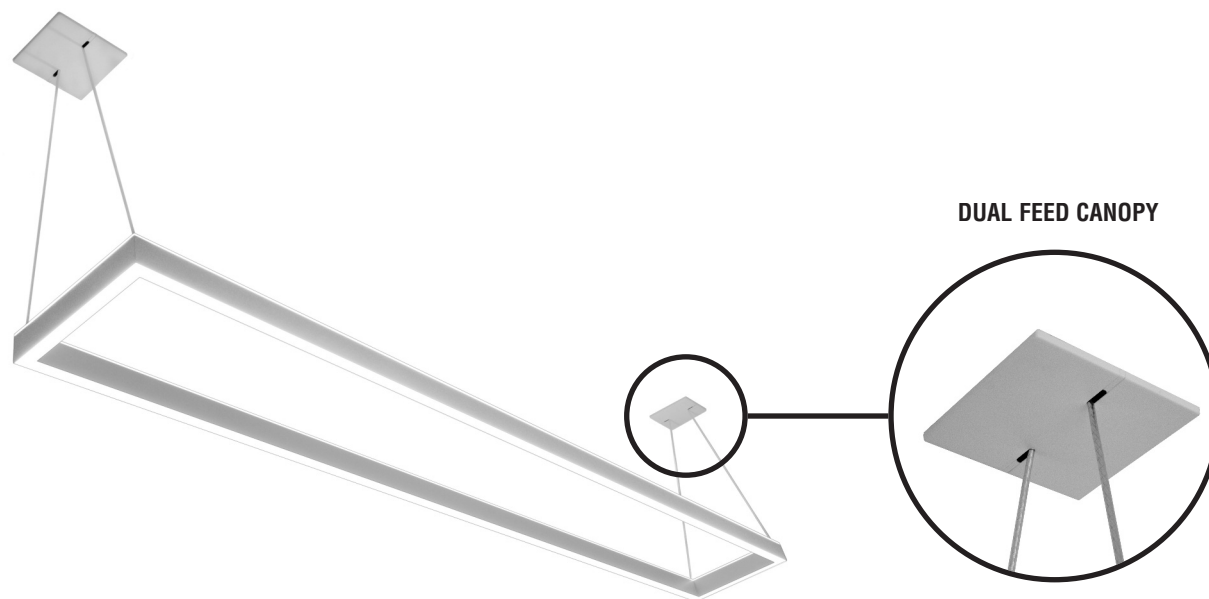

FINELITE

E2 Indirect/Direct (E2-ID) Configuration

PHOTOMETRY - ↑Flush / ↓Flush Diffuser (E2-ID-L-4'-V-V-835-F-F)

Very High Output / Very High Output - 4' Luminaire

Distribution: 61% Up (V) / 39% Down (V)

Efficacy: 99 lumens per watt

Uplight: 2250 lumens (563 lumens/foot)

Downlight: 1440 lumens (360 lumens/foot)

Total Luminaire Output: 3690 lumens (923 lumens/foot)
37.2 watts (9.3 watts/foot)

CCT: 3500K; CRI: 80

ITL LM79 Report 89277

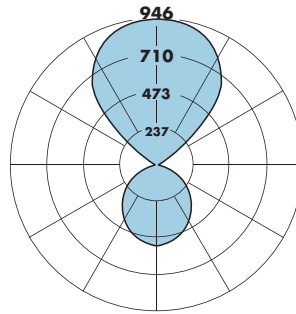

↑ Indirect ↓ Direct

Light Output, 3500K, 80 CRI (Lumens Per Foot)				
	↑S*	↑B*	↑H*	↑V**
↓S*	378	437	585	710
↓B*	416	475	623	748
↓H*	510	569	718	843
↓V*	590	649	798	923

Power, 3500K, 80 CRI (Watts Per Foot)				
	↑S*	↑B*	↑H*	↑V**
↓S*	3.8	4.3	5.5	6.6
↓B*	4.3	4.8	6.0	7.0
↓H*	5.5	6.0	7.2	8.3
↓V*	6.6	7.0	8.3	9.3

Efficacy, 3500K, 80 CRI (Lumens Per Watt)				
	↑S*	↑B*	↑H*	↑V**
↓S*	99	101	106	108
↓B*	96	99	104	106
↓H*	93	95	100	102
↓V*	90	92	97	99

S - Standard Output, B - Boosted Standard Output, H - High Output, V - Very High Output

* Family Correlation based on 4' luminaire 3500K Very High Output (V) test - 120V.

** Correlation based on ITL report: 89277

CANDELA DISTRIBUTION						
	0.0	22.5	45	67.5	90	Flux
0	520	520	520	520	520	
5	518	518	518	518	518	49
15	497	494	497	497	497	140
25	457	452	456	455	454	209
35	400	395	398	397	396	248
45	332	328	330	328	327	254
55	257	254	254	253	253	227
65	179	176	175	175	175	174
75	102	100	99	99	100	106
85	29	28	29	29	30	32
90	0	0	0	0	0	
95	20	18	14	11	11	18
105	114	93	70	56	52	82
115	278	236	165	124	113	181
125	471	426	377	265	229	320
135	644	618	579	567	535	449
145	772	759	740	712	708	461
155	862	851	857	845	837	391
165	918	912	916	914	912	258
175	943	942	942	942	942	90
180	946	946	946	946	946	

Lumen Adjustment Factors - 80 CRI	
3000K	0.985
3500K	1.000
4000K	1.032

Lumen Adjustment Factors - 90 CRI	
3000K	0.746
3500K	0.760
4000K	0.789

Apply a lumen adjustment factor to calculate lumens for the desired CCT and CRI.

SAMPLE LUMEN ADJUSTMENT CALCULATION

High Output (H) / Standard Output (S),
4000K, 90CRI

Lumen Adjustment Factor = 0.789

Total Light Output =
2339 lm x 0.789 = 1845 lm

Total Light Output per Foot =
585 lm/ft x 0.789 = 462 lm/ft

watts/foot = 5.5 W/ft

$$\text{Efficacy} = \frac{462 \frac{\text{lm}}{\text{ft}}}{5.5 \frac{\text{W}}{\text{ft}}} = 84 \text{ lm/W}$$

FINELITE

E2 Indirect/Direct (E2-ID) Configuration

SPECIFICATIONS

CONSTRUCTION: Precision cut 6061-T6 extruded aluminum body. Top Glow™ diffuser snaps into place and is easily removed for service.

UPLIGHT DIFFUSER: The Top Glow diffuser is frost white standard. Coupled with light engine design, the diffuser spreads the light evenly for enhanced ceiling uniformity. Optional: Flush frost white snap-in diffuser.

DOWNLIGHT DIFFUSER: Flush frost white snap-in diffuser standard. Coupled with light engine design, the diffuser spreads the light evenly for enhanced distribution.

LIGHT OUTPUT: Four lumen packages available, Standard (S), Boosted Standard (B), High (H), and Very High (V). A separate chart summarizes lumen distribution and wattage.

LIGHT ENGINE: The replaceable light engines are made up of high performance mid-power LEDs and designed to distribute heat properly to maximize the life of the LEDs and the driver.

LUMEN MAINTENANCE: 90% of initial light output (L90) at 100,000+ hours; 70% of initial light output (L70) at 200,000+ hours.

DRIVER: Replaceable 120V/277V and 347V Constant Current Reduction dimming driver standard. Can be wired dimming or non-dimming. 0-10V dimming controls with a range of 10%- 100%. Dimming to 1% available; consult factory. Driver for Low Profile T-Bar Power Supply Box is accessible from above the ceiling. Driver for Large Capacity and Retrofit Power Supply Box are fully accessible from below the ceiling. Power Factor: ≥ 0.9 . Total Harmonic Distortion (THD): $< 20\%$. Step-dimming driver (limited programable outputs. Contact Factory). Expected driver lifetime: 100,000 hours.

ELECTRICAL: 120V or 277V prewired. Emergency to generator/inverter wiring, internal generator transfer switch. Configuration with emergency battery pack (4' only) only available with 2x2 and Large Capacity Box. See Electrical Box Options for more information (page 2). Backup batteries deliver 1542 lumens.



INTEGRATED SENSORS: Integrated Occupancy Sensors can be located in the canopy. Sensors are available when using the following power supply boxes: Low Profile T-Bar (P01), Large Capacity (P02), and Retrofit (P03) power supply boxes.

MOUNTING: Standard E2-ID Configuration mounting is off-grid. Bar Hangers for mounting power supply boxes to joists are ordered separately. Consult Electrical Box Options (Page 2) for maintenance details.

FINISH: Finelite Signal White powder coat finish standard. Optional Adders: 185 RAL colors.

SUPPORT CABLE/FEED: Standard suspension is conductive feed/suspension cable. 4-conductor cable standard delivering independent up light and downlight control. 5-conductor cables when using battery backup. Field adjustable length. Standard Suspension for 1'x2' and 2'x2' is 18" from the canopy to the top of the luminaire. Standard suspension for 1'x4', 1'x8', 2'x3', 2'x4', 3'x3', 3'x4', and 4'x4' is 24". Contact factory for additional lengths.

STANDARD CONFIGURATIONS: Available in 1'x2', 1'x4', 1'x8', 2'x2', 2'x3', 2'x4', 3'x3', 3'x4', and 4'x4' sizes. To find actual dimensions, add 1-1/8" to each section length.

LABELS: Luminaire and electrical components are ETL-listed conforming to UL 2108 in the U.S.A. and CAN/CSA C22.2#9.0 in Canada. In accordance with NEC Code 410.73 (G), this luminaire contains an internal driver disconnect. Damp Location. Power supply boxes are IC Rated and Chicago Plenum approved. Finelite products use electronic components that are RoHS compliant, and the mechanical components of the luminaire have been verified to not knowingly contain any restricted substances listed per RoHS Directive 2011/65/EU. Power supply boxes are IC Rated. Chicago Plenum available. Simply add **RLD** (Declared) to your part number.

WEIGHT: 1.0 lb per foot. 2'x2' weighs 8 lbs.

WARRANTY: 10-year performance-based warranty on all standard components. Optional accessories such as emergency battery packs are covered by their individual manufacturer warranties.