

HP-4 Direct, Recessed, Regressed, and Surface Mount

HP-4 D, R, RG, and SM Recycling Luminaire Breakdown

Luminaire breaks down easily for recycling at the end of usable life*.

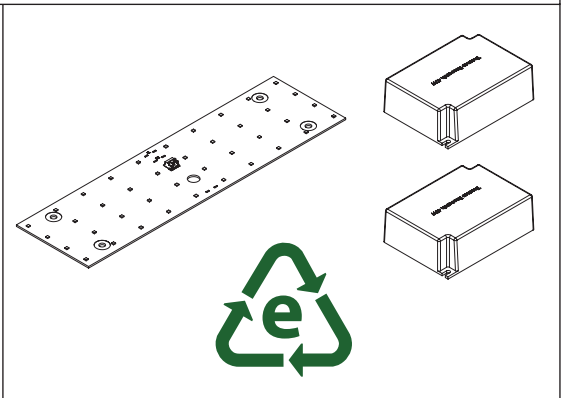
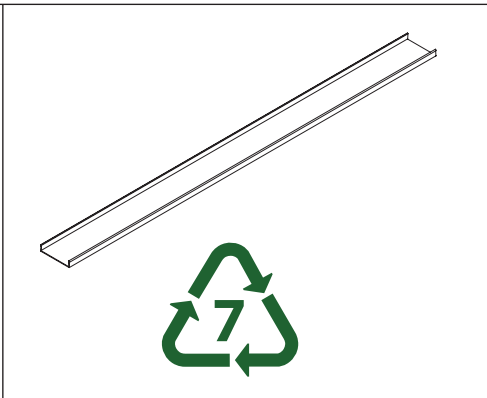
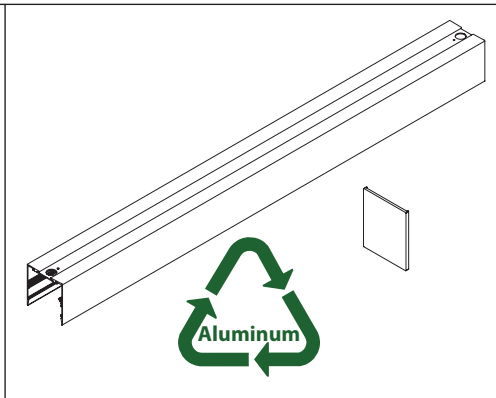
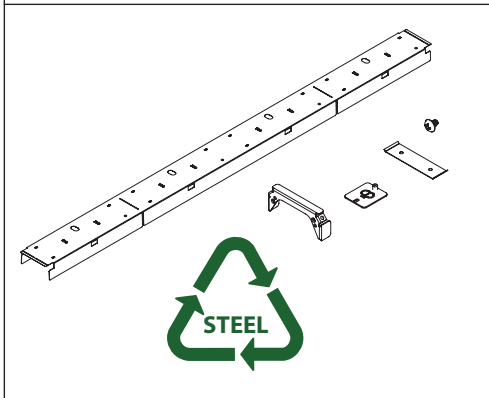
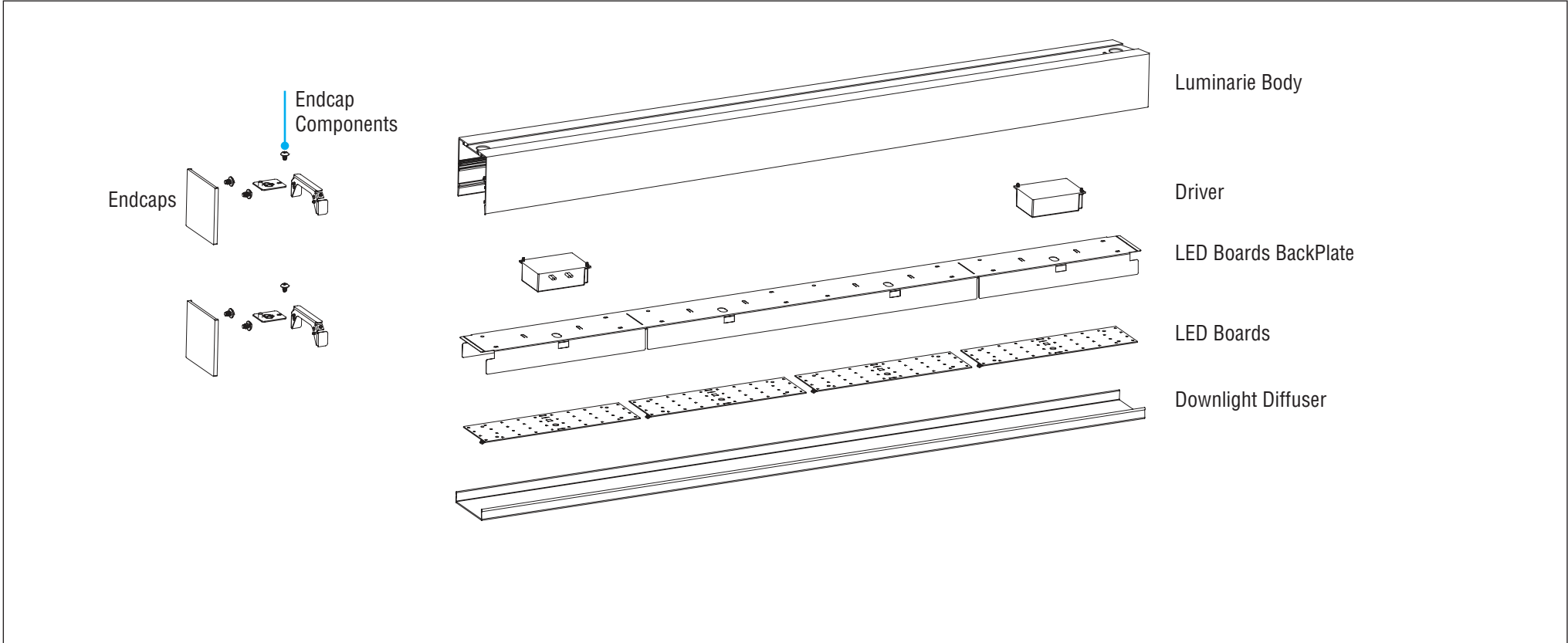

*Recycling information typical for all luminaire sizes. Contact factory for more information.

Protected by one or more US Patents: 8915613; D702,391; D702,390; D700,732

HP-4 Direct, Recessed, Regressed, and Surface Mount

HP-4 D, R, RG, and SM Recycling Luminaire Breakdown

80% Recyclable

HP-4 D components are constructed from aluminum, steel, copper wire, e-waste, and plastic.
HP-4 D is 80% recyclable at the end of useful life.

