

HP-2 Wall Wash Arm Mounted Mounting and Feed Guide

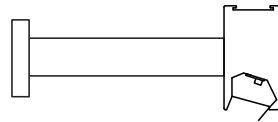

FINELITE®
Better Lighting

Customer: _____ Job: _____ PO: _____

MOUNTING HARDWARE

- Wall Rail Bracket**
43320

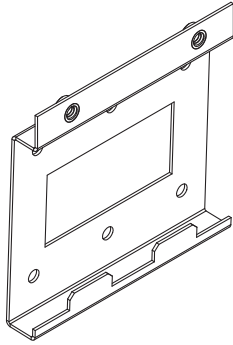

- Wall Bracket Cover**
43322

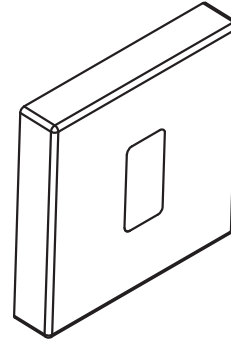

Arm Assembly

- 12"** (43325)
- 15"** (43326)
- 18"** (43327)
- 24"** (43328)

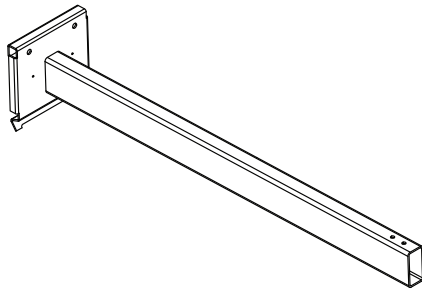

- Inner & Outer Housing Bracket**

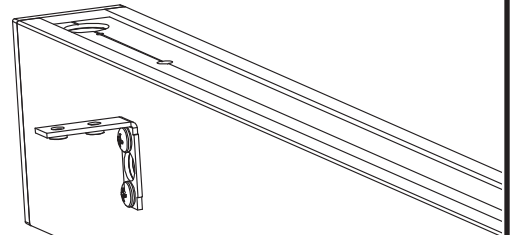

Power Feed

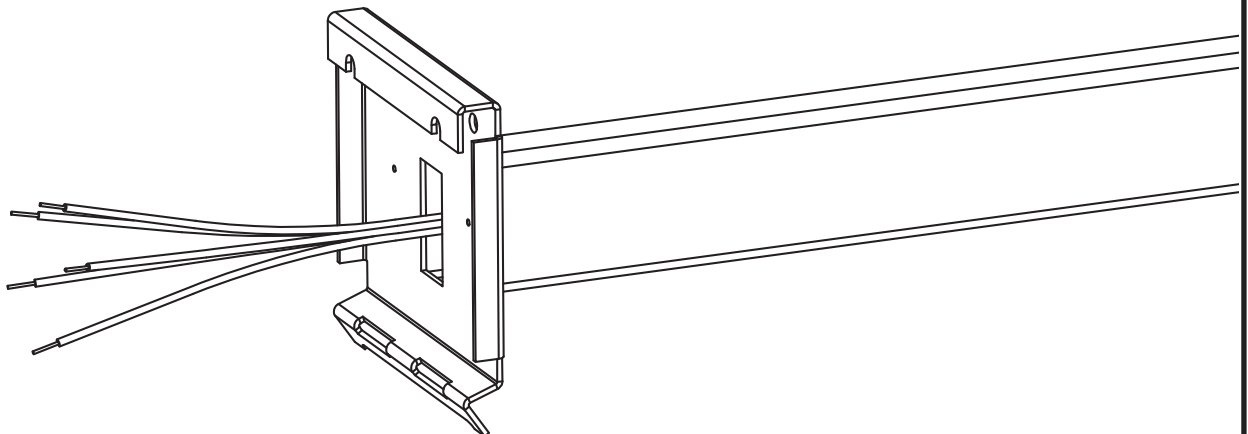

© 2018 FINELITE, INC. ALL RIGHTS RESERVED. CPG0092. 08/18

HP-2 Wall Wash Arm Mounted Mounting and Feed Guide

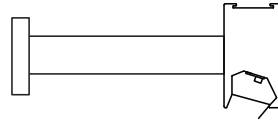

FINELITE®
Better Lighting

RUN LENGTHS & MOUNTING LOCATION EXAMPLES

Tailored Lengths Available Down To 1/16" (±1/32")

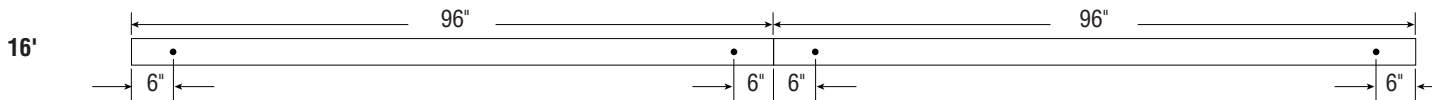
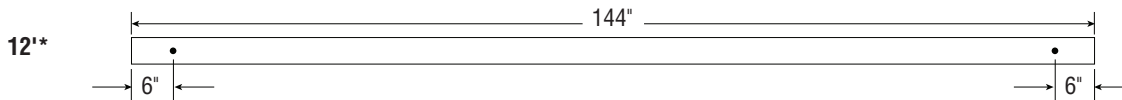
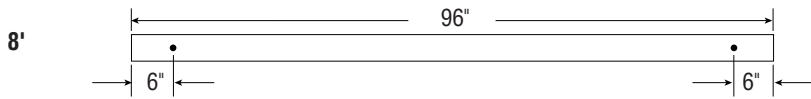
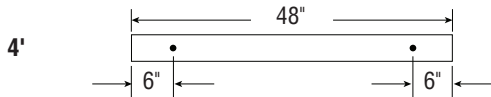
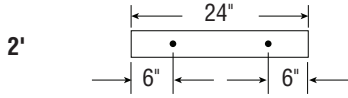

• = Bracket Location

* = 12' Maximum spacing for two arm mount supports

Endcaps Information

The **Flat Endcap** adds 1/4" per endcap to the section length.

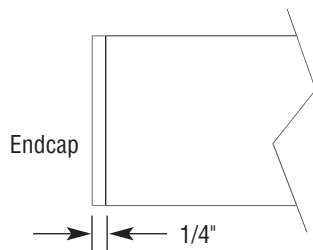

HP-2 Wall Wash Arm Mounted Mounting and Feed Guide

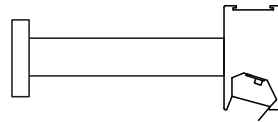

FINELITE[®]
Better Lighting

PROPER POSITIONING

