

E2 Indirect/Direct Linear Pendant Mounting and Feed Guide

Top Glow

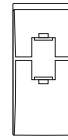

Flush

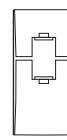

FINELITE[®]
Better Lighting

Customer: _____ Job: _____ PO: _____

SUSPENSION TYPE

Linear Conductive Support Cable

To Power Supply Box

50"- Standard
89512

Retention Collar
(4 conductor)
15691

Retention Collar
(5 conductor)
15694

Custom _____
(Max 14')

Set Screw
15692

To Luminarie

CANOPY TYPE

Power and Non-Power Support

6"- Square (Standard)
15720

3"- Square¹ (Optional)
15743

MOUNTING HARDWARE²

Caddy 512 HD T-Bar Support and Caddy Clip³
94077

Caddy/Erico T-Bar Supports³
64218

Bar Hanger Channel³
68250

CEILING TYPE

1" T-Bar (C1) **9/16" T-Bar** (C2) **Standard Screw Slot** (C3) **Hard Ceiling** (C4)

INTEGRATED SENSOR & EMERGENCY BACKUP BATTERY TEST BUTTON (6" CANOPY ONLY)

Integrated Occupancy Sensor
15722

Integrated Occupancy Sensor & Emergency Backup Battery Test Button
15724

Emergency Backup Battery Test Button
15723

¹ Not available for Large Profile & Large Capacity Power Supply Box for Drywall Ceiling

² E2-ID does not mount directly in alignment to T-Bar Grid / On-Grid

³ Contact factory for pricing

E2 Indirect/Direct Linear Pendant Mounting and Feed Guide

Top Glow

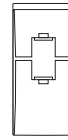

Flush

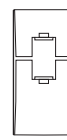

FINELITE[®]
Better Lighting

ELECTRICAL BOX OPTIONS

- Low Profile T-Bar Power Supply Box With 6" Canopy (P01)**
89005

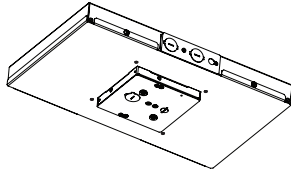

- T-Bar only
- Two driver maximum per box (illuminates up to 8')
- Includes easy leveling system from below ceiling
- Access drivers from above ceiling for simple maintenance
- (7) 1/2" feed knockouts available to connect building power
- Optional occupancy sensor located in canopy for a clean aesthetic

- Large Capacity Power Supply Box With 6" Canopy (P02)**
89008

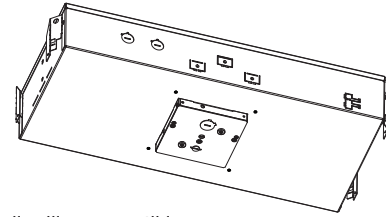

- T-Bar or Drywall ceiling compatible
- Four driver maximum per box (illuminates up to 16') or two drivers (illuminates up to 8') and one EM battery pack for egress (illuminates 4' only)
- Includes easy leveling system from below the ceiling
- Access to drivers from below ceiling to reduce maintenance time
- (4) 1/2" feed knockouts available to connect building power
- Optional Occupancy sensor located in canopy for a clean aesthetic

- Retrofit Angled Power Supply Box With 6" Canopy (P03)**
89006

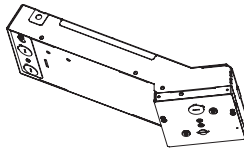

- T-Bar or Drywall ceiling compatible
- Two driver maximum per box (illuminates up to 8')
- Includes easy leveling system from below ceiling
- Access to drivers from below ceiling to reduce maintenance time
- (4) 1/2" feed knockouts available to connect building power
- Optional Occupancy sensor located in canopy for a clean aesthetic

- Support Bracket**
15736

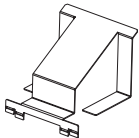

- Splice Box With 6" Canopy (S01)**
89007

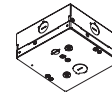

- T-Bar or Drywall ceiling compatible
- Includes easy leveling system from below ceiling

STANDARD FIXTURE LENGTHS & SUPPORT LOCATIONS

Any length, 2-foot minimum, in increments down to 1/16" ($\pm 1/32"$). 8-foot maximum section length. Standard off-grid mounting. A single cable suspends and carries power to the luminaire for a consistent and uniform visual aesthetic throughout the installation.

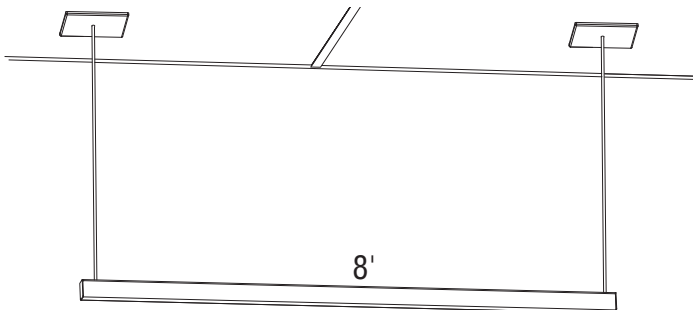

EASY LEVELING SYSTEM ON ALL BOXES (6" CANOPY)

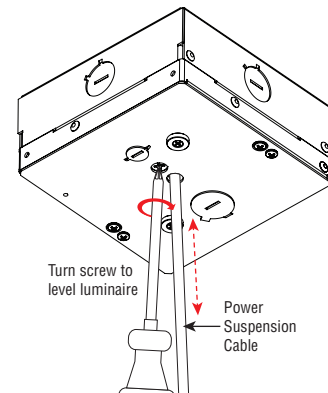

E2 Indirect/Direct Linear Pendant Mounting and Feed Guide

Top Glow

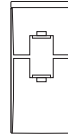

Flush

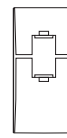

FINELITE[®]
Better Lighting

ELECTRICAL BOX OPTIONS

- Low Profile T-Bar Power Supply Box With 3" Canopy (P04)**
89844

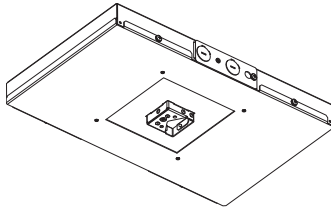

- T-Bar only
- Two driver maximum per box (illuminates up to 8')
- Includes easy leveling system from below ceiling
- Access drivers from above ceiling for simple maintenance
- (7) 1/2" feed knockouts available to connect building power

- Large Capacity Power Supply Box With 3" Canopy (P05)**
89847

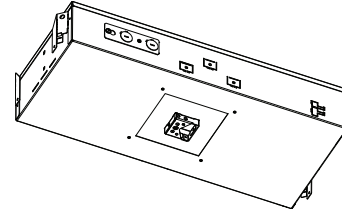

- T-Bar only
- Access drivers from above ceiling only
- Four driver maximum per box (illuminates up to 16')
- Includes easy leveling system from below the ceiling
- (4) 1/2" feed knockouts available to connect building power

- Splice Box With 3" Canopy (S02)**
89846

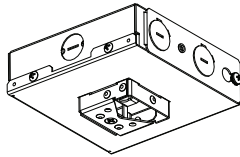

- T-Bar or Drywall ceiling compatible
- Includes easy leveling system from below ceiling

EASY LEVELING SYSTEM ON ALL BOXES (3" CANOPY)

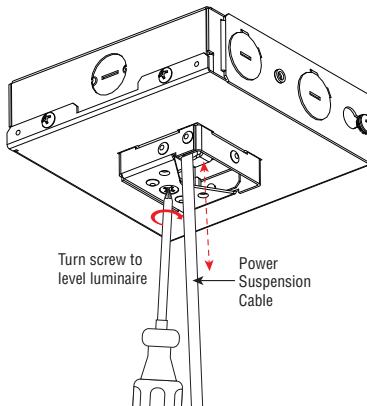

© 2018 FINELITE, INC. ALL RIGHTS RESERVED. CPG0081_V3 EFFECTIVE DATE: 09/24/18

E2 Indirect/Direct Linear Pendant Mounting and Feed Guide

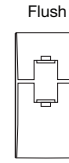
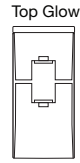

ELECTRICAL SPECIFICATION (For more details, refer to www.finelite.com for the Electrical Box Specification Guide.)

A. 24' run with Low Profile T-Bar Power Supply Boxes (P01). Two drivers in each box. T-Bar ceiling.

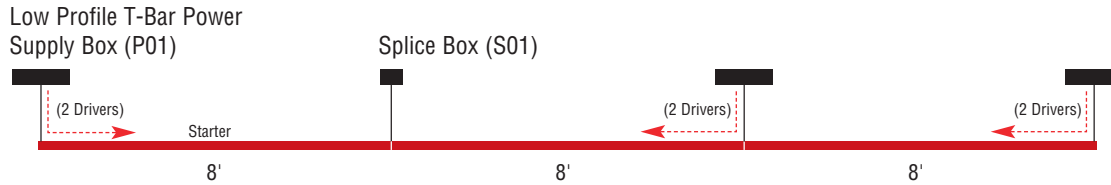

B. 24' run with Large Capacity Power Supply Boxes (P02). Two drivers and one battery backup¹ in first box. Drywall or T-Bar ceiling.

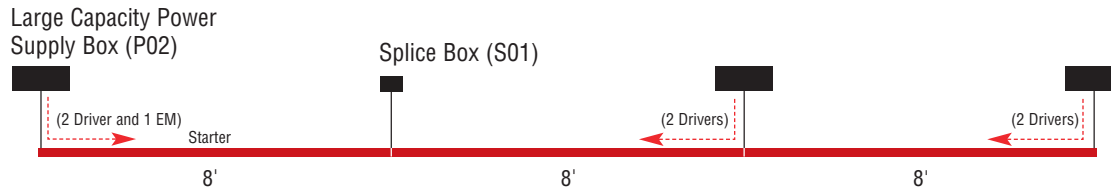

C. 24' run with Retrofit Power Supply Boxes (P03). Two drivers in each box. Drywall or T-Bar ceiling.

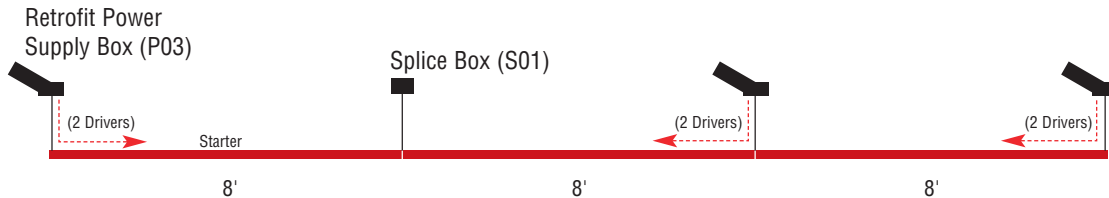

D. 32' run with Large Capacity Power Supply Boxes (P02). Four drivers in each box. Drywall or T-Bar ceiling.

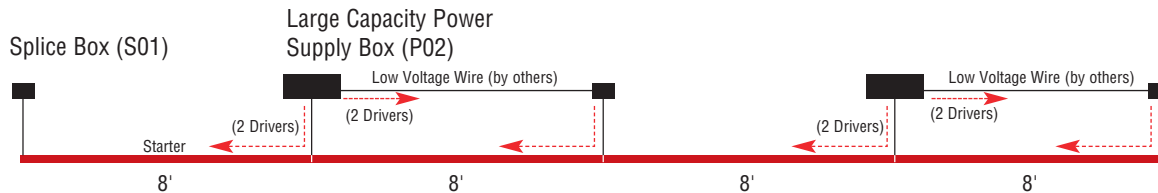

¹ Note: Standard battery backup section is for 4' downlight only.