

FINELITE

Series 6 - Technical Sheet

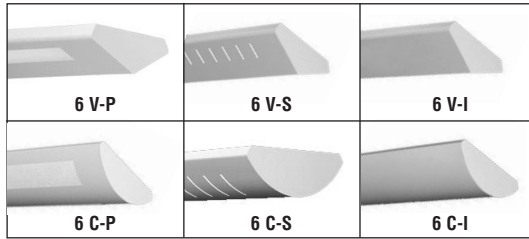
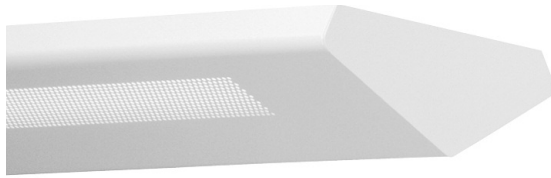

Date

Project

Type

Comments

DESCRIPTION

Series 6 takes advantage of the small diameter of T5 and T5-HO lamps in a low profile fixture that delivers superior light levels. Available in two classic styles, Series 6V (V-shape) and Series 6C (soft curve shape), with slots, perf, or 100% indirect, it is perfect for open offices, classrooms, libraries, and conference rooms. With 1, 2, or 3 T5 or T5-HO lamps, Series 6 adds stylish beauty and unparalleled lumen performance to every setting at an exceptional value.

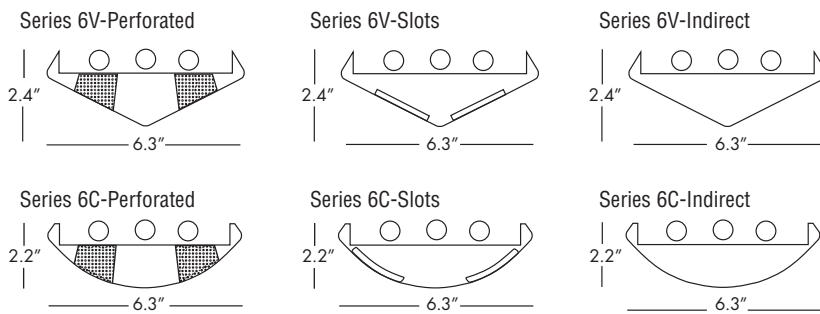

STANDARD PLUG-TOGETHER WIRING:
Plug-together wiring is standard on all fixtures and hardware is located in the lamp compartment.

DIMENSIONS / LAMPING:

Available in 1, 2, 3 T5, or T5HO lamp cross sections.

ORDERING GUIDE

Sample Number: S6V - P - 32' - 1 T5HO - SC - 91W - 277 - AC 18" - FE - C1

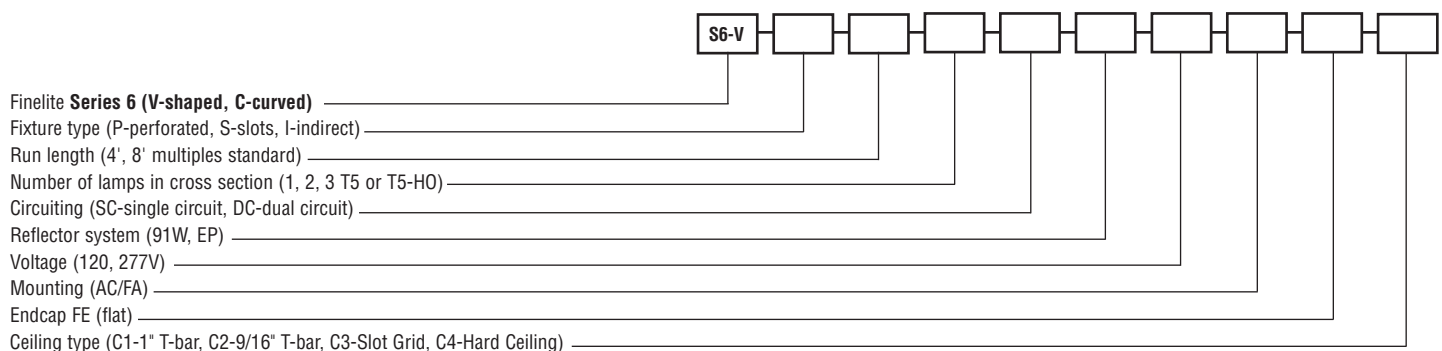

FINELITE

Series 6 - Technical Sheet

PHOTOMETRY

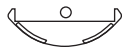

S6C-S: 1 T5HO - EP
 Distribution: 99% Up / 1% Down
 Efficiency: 83.4%
 Peak Candela Value: 1269@ 125"
 LSI Report 49626

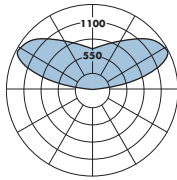

S6C-S: 1 T5HO - 91W
 Distribution: 99% Up / 1% Down
 Efficiency: 86.9%
 Peak Candela Value: 1023@ 135"
 LSI Report 49424

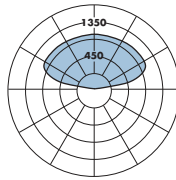

S6C-I: 1 T5HO - 91W
 Distribution: 100% Up / 0% Down
 Efficiency: 85.9%
 Peak Candela Value: 1035@ 145"
 LSI Report 50157

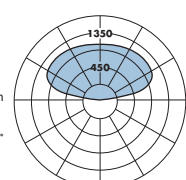

CANDLEPOWER SUMMARY						
	0.0	22.5	45.0	67.5	90.0	Flux
0	6	6	6	6	6	
5	7	6	7	6	5	1
15	6	7	9	9	7	2
25	5	7	8	7	6	3
35	4	6	6	6	5	4
45	4	5	5	5	5	4
55	4	4	4	5	4	4
65	2	3	3	3	3	3
75	1	2	2	2	2	2
85	0	0	1	1	1	1
90	0	0	0	1	1	1
95	22	199	200	211	189	197
105	109	469	694	701	715	605
115	215	523	922	1194	1225	819
125	317	571	912	1171	1269	773
135	413	608	877	1086	1172	651
145	493	631	824	974	1039	502
155	554	641	757	851	892	345
165	597	634	690	731	752	194
175	617	622	624	630	635	60
180	615	615	615	615	615	

CANDLEPOWER SUMMARY						
	0.0	22.5	45.0	67.5	90.0	Flux
0	5	5	5	5	5	
5	5	5	6	5	5	1
15	5	7	9	9	9	2
25	5	7	9	9	9	4
35	6	7	8	7	7	4
45	5	5	6	6	6	4
55	3	4	4	4	4	4
65	2	2	3	3	3	2
75	0	1	2	2	2	1
85	0	0	0	1	1	0
90	0	0	0	0	1	
95	38	221	217	213	203	212
105	190	428	681	787	805	618
115	369	525	761	948	1009	722
125	532	638	815	960	1018	715
135	681	749	872	978	1023	667
145	804	845	919	988	1019	574
155	897	922	955	991	1009	442
165	961	971	980	989	995	277
175	990	995	987	984	986	94
180	989	989	989	989	989	

CANDLEPOWER SUMMARY						
	0.0	22.5	45.0	67.5	90.0	Flux
90	0	0	0	0	0	
95	30	206	203	217	185	198
105	182	423	628	734	748	588
115	356	528	759	926	975	712
125	525	646	821	963	1018	717
135	674	758	882	988	1031	673
145	802	854	936	1005	1035	582
155	900	929	973	1010	1029	448
165	967	980	993	1005	1014	281
175	1001	1004	1001	995	996	95
180	1000	1000	1000	1000	1000	

— Refer to www.finelite.com for additional photometry and product information.

SPECIFICATIONS

CONSTRUCTION: Body is 20-gauge die-formed steel with 18-gauge die-formed internal joiner system, plug-together wiring standard. All components are hard-tooled to tolerances of 0.010".

Series 6 is available in a soft V shape (V) or a soft curve (C) shape with:

- (P) precision-punched 0.066" diameter perforations covering the bottom sides of the fixture in two parallel columns, or
- (S) precision cut slots measuring 0.103" by 1.900", spaced 1.2" apart covering the bottom sides of the fixture in two parallel columns.

Optional: 100% Indirect (I). Consult factory.

ENDCAPS: Flat 18-gauge die-formed steel endcaps standard.

REFLECTORS: Die-formed, 91% reflective white standard (91W). Virgin acrylic UV-stabilized lens diffuser over perforations is standard. Optional: Extended Performance Reflector System (EP). Contact factory.

SUPPORT CABLES: Plated steel cable and hardware.

MOUNTING OPTIONS: Semi-adjustable aircraft cable, (AC) ± 0.5" in lengths of 12", 15", 18", 21", 24", 27", 30", 36". Order length, e.g., AC 18". Optional Adders: fully adjustable aircraft cable (FA) in lengths up to 150".

FINISHES: Finelite Signal White standard. Optional Adders: 185 colors available from Tiger Drylac's RAL color chart.

LAMPING: Available in 1, 2, or 3 T5 or T5HO lamp cross sections.

FEED: 18-gauge straight cord. 14-gauge feed cord used when fixture current exceeds 6 amps. Optional Adders: Coil Cord Feed, Rigid Stem Feed. Consult factory.

ELECTRICAL: 120 or 277V prewired. Fixture and electrical components are UL/C-UL listed and fixture will bear UL/C-UL labels. Optional Adders: Dual circuit, emergency circuits, emergency battery packs. Contact factory.

BALLAST: Electronic rapid-start ballasts <10% THD standard. Optional adders: 347V, emergency battery packs, dimming ballasts (controls by others). Specify T5 or T5HO.

LENGTHS: 4' and 8' section lengths can be combined to make longer runs. Contact factory for additional lengths.

WEIGHT: Fixture weight = 2.5 lb/ft.

LABELS: Fixture and electrical components are ETL listed conforming to UL 1598 in the U.S.A., and Canada; ETL listed to certified CAN/CSA C22.2 No. 250.0. Fixtures will bear ETL labels.