



HPR-LED Collection
2011 IES Progress
Report Selection



Date

Project

Type

Comments

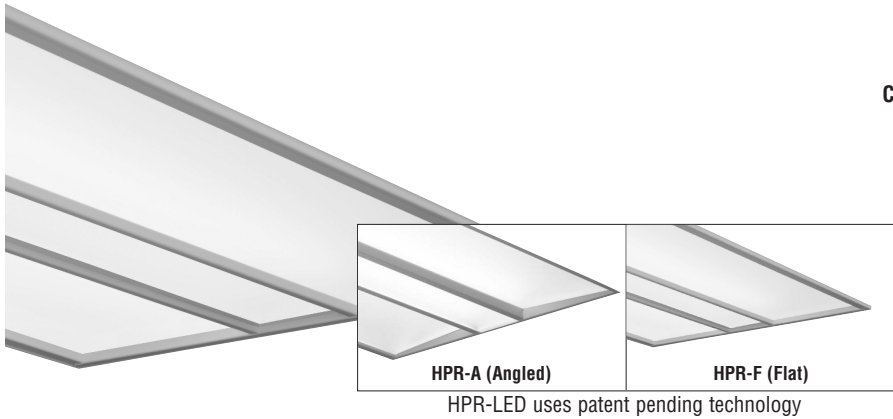

DESCRIPTION

HPR-LED is a highly effective recessed luminaire delivering excellent visual comfort and outstanding performance for offices, schools, healthcare, and retail applications. Advanced optical designs make HPR-LED a powerful solution for low-ceiling applications and eliminate the shadows common to other LED recessed products. HPR-LED RoHS compliant.

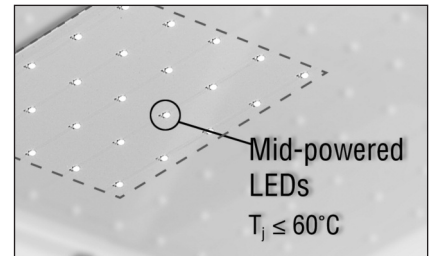

GLARE-FREE ILLUMINATION:

A glare-free experience is attained with mid-powered LEDs properly distributed and paired with a precise diffuser to eliminate pixilation.

100% SERVICEABLE FROM BELOW:

The light engine and driver can be easily changed from below ceiling – and it's simple to install.

THERMAL MANAGEMENT:

Mid-powered LEDs allow heat to be fully dissipated without the need for additional heat sinks.

ORDERING GUIDE

Sample Number: HPR - A - 2x4- DCO - LED-SO - 4000K - 277V - SC - C1 - OBO - AR

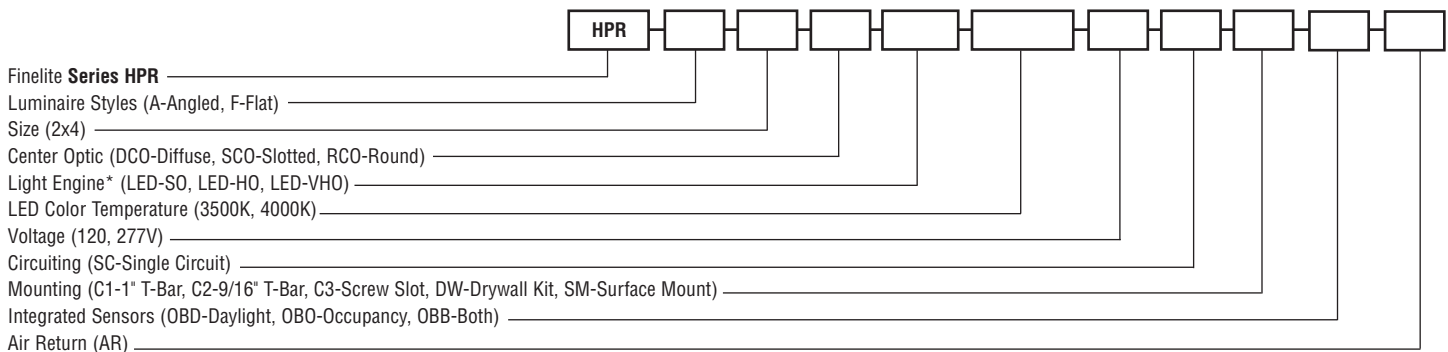

* SO = Standard Output 3721 lumens (4000K) HO = High Output 5568 lumens (4000K) VHO = Very High Output 6085 lumens (3500K), 6359 lumens (4000K)

High Performance Recessed (HPR-LED) 2x4

PHOTOMETRY

HPR-LED-SO-A-DCO (2x4)
 105.7 Lumens Per Watt
 3721 Lumens/35.2 Watts
 CRI: 83
 R9: 11
 CCT: 4000K
 ITL LM79 Report 71937

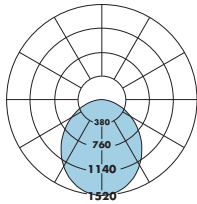
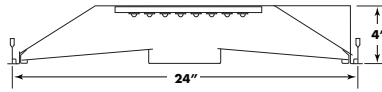

— Refer to www.finelite.com for additional photometry and product information.

CANDLEPOWER SUMMARY						
	0.0	22.5	45	67.5	ACROSS	Flux
0	1521	1521	1521	1521	1521	
5	1515	1513	1507	1501	1498	143
10	1489	1485	1478	1467	1465	
15	1445	1438	1429	1416	1409	402
20	1385	1376	1360	1346	1340	
25	1308	1302	1278	1265	1251	589
30	1217	1210	1181	1165	1154	
35	1119	1106	1079	1059	1051	676
40	1010	994	966	946	935	
45	897	877	852	831	825	661
50	775	764	734	723	707	
55	661	647	622	607	600	560
60	548	532	509	497	493	
65	432	417	402	391	387	403
70	322	317	298	297	289	
75	228	218	210	205	202	224
80	135	130	126	124	121	
85	59	58	54	50	48	63
90	0	0	0	0	0	

PHOTOMETRY

HPR-LED-VHO-A-DCO (2x4)
 89.9 Lumens Per Watt
 6085 Lumens/67.7 Watts
 CRI: 83
 R9: 13.3
 CCT: 3500K
 ITL LM79 Report 69558

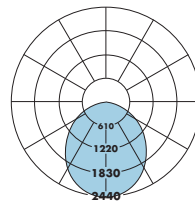
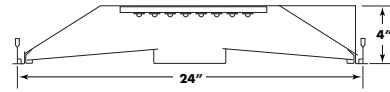

— Refer to www.finelite.com for additional photometry and product information.

CANDLEPOWER SUMMARY						
	0.0	22.5	45	67.5	ACROSS	Flux
0	2426	2426	2426	2426	2426	
5	2417	2415	2407	2401	2398	229
10	2374	2372	2374	2357	2353	
15	2303	2300	2295	2287	2285	647
20	2207	2213	2200	2190	2190	
25	2090	2091	2080	2076	2085	958
30	1944	1950	1935	1935	1927	
35	1794	1790	1785	1778	1776	1113
40	1617	1614	1611	1597	1593	
45	1429	1426	1420	1414	1409	1097
50	1235	1243	1228	1232	1212	
55	1057	1055	1047	1038	1032	933
60	860	864	859	844	834	
65	675	678	672	661	655	665
70	498	510	493	495	483	
75	332	342	328	333	319	355
80	193	190	189	189	185	
85	73	75	72	73	71	89
90	0	0	0	0	0	

SPECIFICATIONS

CONSTRUCTION: Fixture assembly constructed using die-formed 20-gauge cold-rolled steel housing and ends. All components are hard-tooled to tolerances of 0.010". Driver compartment is accessible from below. Optical system retained using hinged door frame assembly to provide easy access to driver compartment and for servicing from below without the need of tools. Seismic brackets are integrated into the fixture assembly. Additional wire entrances are positioned on the ends of the housing to allow easy wiring access for the installer.

REFLECTORS: Die-formed 20-gauge cold-rolled steel reflectors are finished in 96 LG high reflectance matte white powder coat paint.

OPTICAL SYSTEM: Optical system components include diffuser panels and a center optic element held in place with a frame constructed from die-formed cold-rolled steel. The diffusers are UV-stabilized and impact-resistant frosted virgin acrylic, 0.120" thick. They are either angled toward the center optic or parallel to the ceiling plane.

Available options for the center optic elements:

Diffuse Center Optic: UV-stabilized and impact-resistant frosted virgin acrylic.

Slotted Center Optic: Die-formed cold-rolled steel panel with 1/16" x 1/2" rectangular hole pattern. Virgin acrylic overlay.

Round Center Optic: Die-formed cold-rolled steel panel with precision-punched 3/32" round hole pattern arranged in staggered formation. Virgin acrylic overlay.

LIGHT ENGINE: 2X4 HPR-LED-SO (4000K) delivers 3721 lumens at 35.2W, 2X4 HPR-LED-HO (4000K) delivers 5568 lumens at 56.2W, 2x4 HPR-LED-VHO (4000K) delivers 6359 lumens at 68.6W, and 2x4 HPR-LED-VHO (3500K) delivers 6085 lumens at 67.7W. Standard, high output and very high output lumen packages available. Contact factory for SO and HO 3500K lumen packages. Light engine is made up of high performance mid-powered LEDs and is designed to distribute heat properly to maximize the life of the LED. LED color temperature: 3500K or 4000K. CRI: 83 (4000k), R9:11, 83 (3500k), R9: 13.3.

DRIVER: High performance LED driver. Driver is fully accessible from below the ceiling. *120/277v. Power Factor = 98.7% (4000K), 98.1% (3500K). Contact factory for Emergency Battery backups. Total harmonic distortion (THD) <20%. Input current: 0.58A @ 120VAC, and 0.25A @ 277VAC.

*Driver can be wired as dimming or non-dimming. Dimming is compatible with 0-10v controls with a range of 100-25%.

ELECTRICAL: Fixtures and electrical components are ETL listed conforming to UL1598 in the USA, and Canada and ETL listed certified to CAN/CSA C22.2 No. 250.0. In accordance with NEC code 410.73 (G) this luminaire

contains an internal driver disconnect. Optional Chicago Plenum available. Contact factory.



INTEGRATED SENSORS: Refer to Occupancy Sensor and Daylight Sensor tech sheets for more info.

MOUNTING: Standard flange design works with most lay-in ceiling types. Integral pryout tabs secure luminaire to ceiling grid from above. Fixture offers tie-in locations for tie-wire on all corners. Consult local code for appropriate tie-wire recommendations. Drywall Kit available. Surface mount version available; refer to separate tech sheet.

AIR RETURN: Refer to 2x4 Air Return tech sheet for more info.

FEED: 18-gauge wire standard.

FINISH: Housing and door assembly painted with 96 LG high reflectance matte white powder coat paint. Available in matte white only.

WEIGHT: Maximum weight: 2x4 - 33 lbs.

WARRANTY: HPR-LED comes standard with a 10-year, warranty on all components.

DLC Qualified: HPR-LED 2x4 VHO lumen output with Diffuse Center Optic (DCO) is qualified under the DesignLights™ Consortium program.