

***Reports print in the following order:***

S10- A12- Open- EP  
S10- A12- Open- 91W  
S10- PS- Open- EP  
S10- PS- Open- 91W  
S10- WCB- Open- EP  
S10- WCB- Open- 91W  
S10- WCB- CCO- 91W  
S10- WCB- STO- 91W  
S10- WCB- TDO- 91W  
S10- PLV- Open- EP  
S10- PLV- Open- 91W  
S10- PLV- CCO- EP  
S10- PLV- CCO- 91W  
S10- PLV- STO- 91W  
S10- PLV- TDO- 91W  
S10- CUB- Open- 91W  
S10- CUB- STO/TDO-91W

### Photometric Reports

#### SERIES 10: A12 - OPEN - 1 T8 - EP (ITL REPORT 50840)



85% Uplight  
15% Downlight



LEGEND:  
0-deg. - - - - -  
45-deg. - - - - -  
90-deg. ————

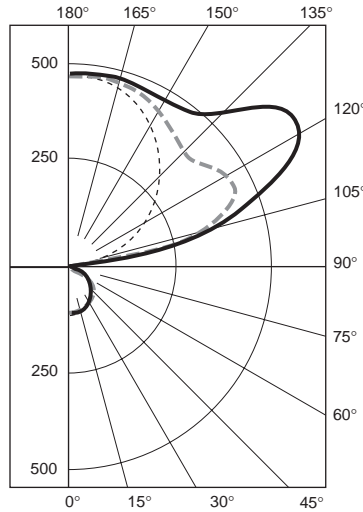

#### ZONAL LUMEN SUMMARY

ZONE	LUMENS	%LAMP	%FIXT
0-30	86	3.1	3.6
0-40	142	5.1	5.9
0-60	253	9.0	10.4
0-90	326	11.6	13.4
90-120	749	26.8	30.9
90-130	1126	40.2	46.5
90-150	1714	61.2	70.7
90-180	2097	74.9	86.6
0-180	2423	86.5	100.0

TOTAL LUMINAIRE EFFICIENCY = 86.5%

#### CANDELA DISTRIBUTION

	0.0	22.5	45.0	67.5	90.0	FLUX
0	111	111	111	111	111	
5	111	111	111	110	109	10
15	107	107	108	108	107	30
25	99	100	100	101	99	46
35	88	90	89	90	88	56
45	74	77	75	76	74	58
55	58	61	59	60	58	53
65	40	43	41	42	40	41
75	21	24	23	24	22	24
85	4	7	6	7	5	7
90	0	0	0	0	0	
95	15	72	81	87	81	80
105	81	205	314	349	342	282
115	159	235	435	542	564	388
125	237	286	412	563	609	377
135	310	344	403	488	524	321
145	370	393	427	461	476	267
155	420	431	453	468	475	208
165	451	456	463	470	473	131
175	467	469	468	465	466	45
180	466	466	466	466	466	

#### SERIES 10: A12 - OPEN - 2 T8 - EP (ITL REPORT 50841)



85% Uplight  
15% Downlight



LEGEND:  
0-deg. - - - - -  
45-deg. - - - - -  
90-deg. ————

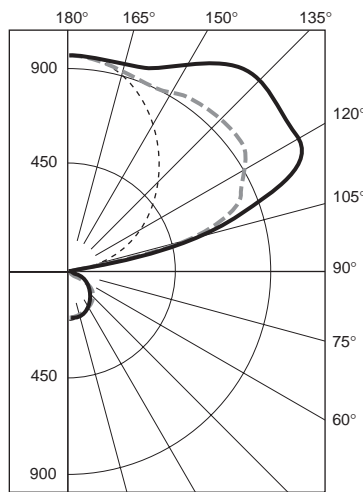

#### ZONAL LUMEN SUMMARY

ZONE	LUMENS	%LAMP	%FIXT
0-30	176	3.1	3.6
0-40	288	5.1	5.9
0-60	513	9.2	10.5
0-90	662	11.8	13.6
90-120	1376	24.6	28.2
90-130	2142	38.3	43.9
90-150	3435	61.3	70.4
90-180	4216	75.3	86.4
0-180	4878	87.1	100.0

TOTAL LUMINAIRE EFFICIENCY = 87.1%

#### CANDELA DISTRIBUTION

	0.0	22.5	45.0	67.5	90.0	FLUX
0	224	224	224	224	224	
5	224	224	223	221	219	21
15	216	217	217	217	215	61
25	200	203	202	203	199	93
35	178	182	180	181	177	113
45	150	154	151	153	149	117
55	118	123	118	121	118	107
65	80	86	83	86	81	83
75	42	49	46	50	45	50
85	10	16	13	16	13	16
90	0	0	0	0	0	
95	32	125	130	145	131	136
105	168	403	556	571	544	496
115	327	542	809	999	1035	744
125	485	634	917	1067	1133	766
135	630	702	943	1123	1181	709
145	753	789	930	1065	1119	584
155	852	870	905	974	1011	427
165	918	926	933	943	948	264
175	951	952	948	944	946	90
180	949	949	949	949	949	

### Photometric Reports

SERIES 10: A12 - OPEN - 3 T8 - EP (ITL REPORT 50842)

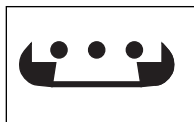

80% Uplight  
20% Downlight



LEGEND:  
0-deg. - - - - -  
45-deg. - - - - -  
90-deg. ————

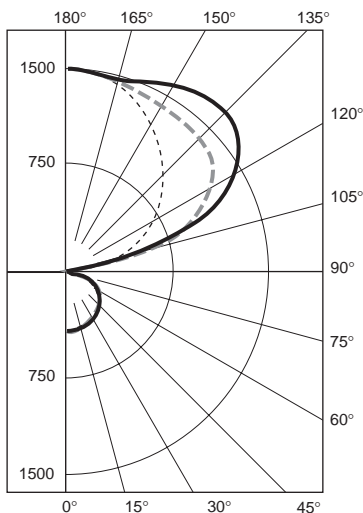

TOTAL LUMINAIRE EFFICIENCY = 85.1%

CANDELA DISTRIBUTION						FLUX	
	0.0	22.5	45.0	67.5	90.0		
0	421	421	421	421	421		
5	422	422	420	417	413	40	
15	406	408	409	409	406	115	
25	377	382	381	382	376	176	
35	336	343	338	340	335	212	
45	282	291	284	288	281	221	
55	221	230	224	229	221	202	
65	151	162	155	161	152	156	
75	79	91	86	92	84	93	
85	17	28	22	27	21	27	
90	0	0	0	0	0		
95	50	118	116	128	110	131	
105	268	560	579	558	531	557	
115	516	791	1091	1198	1186	966	
125	771	936	1313	1525	1571	1106	
135	998	1083	1374	1612	1692	1047	
145	1193	1235	1392	1557	1631	878	
155	1348	1369	1410	1488	1530	660	
165	1452	1460	1468	1476	1482	415	
175	1504	1507	1500	1490	1491	143	
180	1502	1502	1502	1502	1502		

#### ZONAL LUMEN SUMMARY

ZONE	LUMENS	%LAMP	%FIXT
0-30	331	3.9	4.6
0-40	543	6.5	7.6
0-60	966	11.5	13.5
0-90	1243	14.8	17.4
90-120	1654	19.7	23.1
90-130	2760	32.9	38.6
90-150	4685	55.8	65.6
90-180	5904	70.3	82.6
0-180	7146	85.1	100.0

For layouts or additional photometry, contact your local representative or the factory.

### Photometric Reports

#### SERIES 10: A12 - OPEN - 1 T8 - 91W (ITL REPORT 50796)



85% Uplight  
15% Downlight



LEGEND:  
0-deg. - - - - -  
45-deg. - - - - -  
90-deg. ————

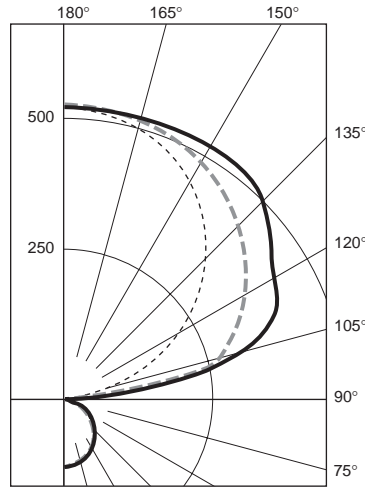

TOTAL LUMINAIRE EFFICIENCY = 85.6%

CANDELA DISTRIBUTION						FLUX
	0.0	22.5	45.0	67.5	90.0	
0	113	113	113	113	113	
5	114	114	113	112	111	11
15	109	110	110	111	110	31
25	101	103	103	103	102	47
35	90	93	91	92	90	57
45	76	79	77	78	76	60
55	60	62	60	62	60	55
65	41	44	42	44	41	42
75	22	25	24	25	23	25
85	5	8	6	8	6	8
90	0	0	0	0	0	
95	17	86	89	103	90	89
105	92	175	272	345	363	263
115	181	248	330	393	415	316
125	267	320	391	447	463	341
135	346	382	439	483	498	334
145	413	435	474	506	517	295
155	466	477	498	517	524	230
165	501	505	511	517	520	145
175	520	520	519	516	515	49
180	518	518	518	518	518	

#### ZONAL LUMEN SUMMARY

ZONE	LUMENS	%LAMP	%FIXT
0-30	89	3.2	3.7
0-40	147	5.2	6.1
0-60	261	9.3	10.9
0-90	337	12.0	14.0
90-120	668	23.9	27.9
90-130	1008	36.0	42.1
90-150	1637	58.5	68.3
90-180	2060	73.6	86.0
0-180	2397	85.6	100.0

#### SERIES 10: A12 - OPEN - 2 T8 - 91W (ITL REPORT 50797)



85% Uplight  
15% Downlight



LEGEND:  
0-deg. - - - - -  
45-deg. - - - - -  
90-deg. ————

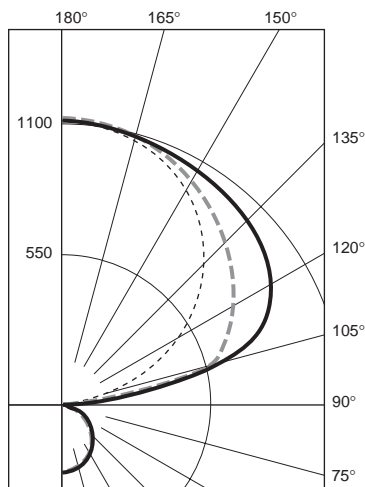

TOTAL LUMINAIRE EFFICIENCY = 86.5%

CANDELA DISTRIBUTION						FLUX
	0.0	22.5	45.0	67.5	90.0	
0	230	230	230	230	230	
5	231	231	230	228	226	22
15	222	223	224	225	223	63
25	206	209	209	210	207	96
35	183	189	186	187	183	116
45	154	160	155	157	153	121
55	121	127	122	126	120	111
65	83	89	85	88	83	85
75	43	50	47	50	46	51
85	9	16	12	15	12	15
90	0	0	0	0	0	
95	34	137	137	151	139	141
105	202	364	516	586	577	483
115	387	508	688	830	872	656
125	574	651	796	920	962	702
135	743	790	887	982	1014	684
145	884	913	966	1025	1048	607
155	996	1010	1037	1064	1074	479
165	1072	1077	1080	1087	1093	306
175	1110	1111	1105	1099	1101	105
180	1107	1107	1107	1107	1107	

#### ZONAL LUMEN SUMMARY

ZONE	LUMENS	%LAMP	%FIXT
0-30	181	3.2	3.7
0-40	298	5.3	6.1
0-60	529	9.4	10.9
0-90	681	12.2	14.1
90-120	1280	22.9	26.4
90-130	1982	35.4	40.9
90-150	3273	58.4	67.6
90-180	4162	74.3	85.9
0-180	4843	86.5	100.0

KSID:3040.0301

### Photometric Reports

SERIES 10: A12 - OPEN - 3 T8 - 91W (ITL REPORT 50798)



80% Uplight  
20% Downlight



LEGEND:  
0-deg. - - - - -  
45-deg. - - - - -  
90-deg. ————

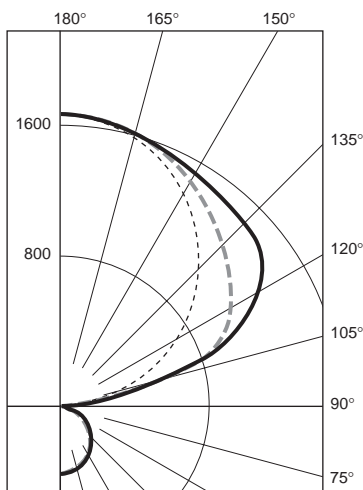

TOTAL LUMINAIRE EFFICIENCY = 83.7%

CANDELA DISTRIBUTION					FLUX	
	0.0	22.5	45.0	67.5	90.0	
0	422	422	422	422	422	
5	423	423	421	418	414	40
15	407	409	410	410	407	116
25	378	383	383	384	378	176
35	337	345	339	342	336	213
45	284	293	286	290	283	222
55	223	231	223	229	222	203
65	151	161	154	160	152	155
75	79	89	84	90	82	91
85	16	26	21	27	20	26
90	0	0	0	0	0	
95	55	120	127	128	127	132
105	295	502	569	571	572	544
115	579	738	955	1029	1043	873
125	850	943	1165	1335	1368	1017
135	1101	1161	1304	1442	1491	1006
145	1313	1346	1426	1509	1548	896
155	1484	1497	1533	1569	1584	708
165	1595	1598	1605	1611	1616	454
175	1650	1652	1646	1635	1635	157
180	1649	1649	1649	1649	1649	

#### ZONAL LUMEN SUMMARY

ZONE	LUMENS	%LAMP	%FIXT
0-30	332	3.9	4.7
0-40	545	6.5	7.8
0-60	970	11.5	13.8
0-90	1242	14.8	17.7
90-120	1549	18.4	22.0
90-130	2566	30.5	36.5
90-150	4468	53.2	63.6
90-180	5786	68.9	82.3
0-180	7029	83.7	100.0

For layouts or additional photometry, contact your local representative or the factory.

### Photometric Reports

#### SERIES 10: PS - OPEN - 1 T8 - EP (ITL REPORT 50837)

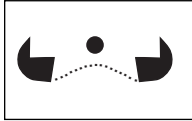

90% Uplight  
10% Downlight



LEGEND:  
0-deg. - - - - -  
45-deg. - - - - -  
90-deg. ————

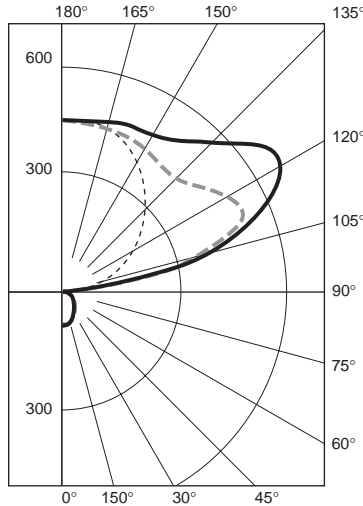

#### ZONAL LUMEN SUMMARY

ZONE	LUMENS	%LAMP	%FIXT
0-30	62	2.2	2.6
0-40	96	3.4	4.1
0-60	143	5.1	6.1
0-90	174	6.2	7.4
90-120	799	28.5	33.9
90-130	1203	43.0	51.1
90-150	1805	64.5	76.7
90-180	2179	77.8	92.6
0-180	2354	84.1	100.0

TOTAL LUMINAIRE EFFICIENCY = 84.1%

#### CANDELA DISTRIBUTION

	0.0	22.5	45.0	67.5	90.0	FLUX
0	86	86	86	86	86	
5	86	86	85	85	83	8
15	80	80	80	80	79	22
25	68	70	69	70	67	32
35	55	57	54	52	46	33
45	40	41	33	30	27	27
55	26	25	20	22	23	21
65	14	15	18	21	21	17
75	6	9	10	12	12	11
85	1	2	3	4	3	3
90	0	0	0	0	0	
95	15	76	77	90	76	82
105	82	233	323	357	342	295
115	159	259	484	597	608	422
125	234	292	446	612	668	404
135	301	342	417	526	566	334
145	360	387	429	469	490	269
155	405	418	442	462	470	204
165	435	440	448	455	460	127
175	451	452	451	448	449	43
180	450	450	450	450	450	

#### SERIES 10: PS - OPEN - 2 T8 - EP (ITL REPORT 50838)

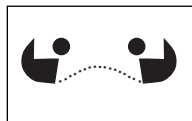

90% Uplight  
10% Downlight



LEGEND:  
0-deg. - - - - -  
45-deg. - - - - -  
90-deg. ————

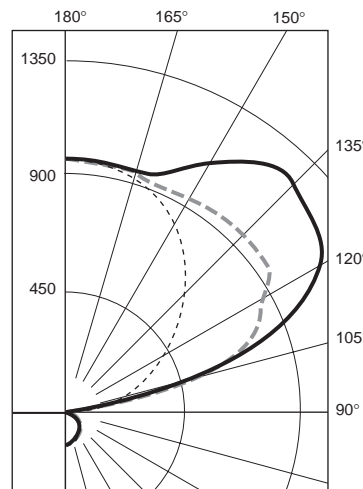

#### ZONAL LUMEN SUMMARY

ZONE	LUMENS	%LAMP	%FIXT
0-30	103	1.8	2.2
0-40	168	3.0	3.6
0-60	299	5.3	6.4
0-90	376	6.7	8.1
90-120	1386	24.8	29.7
90-130	2174	38.8	46.6
90-150	3498	62.5	74.9
90-180	4293	76.7	91.9
0-180	4669	83.4	100.0

TOTAL LUMINAIRE EFFICIENCY = 83.4%

#### CANDELA DISTRIBUTION

	0.0	22.5	45.0	67.5	90.0	FLUX
0	146	146	146	146	146	
5	146	146	142	141	136	13
15	136	132	127	127	125	36
25	117	112	112	119	121	53
35	93	92	103	117	120	65
45	66	75	91	106	108	69
55	43	58	71	84	82	62
65	27	37	43	50	46	42
75	13	20	25	33	32	26
85	2	8	8	10	7	9
90	0	0	0	0	0	
95	30	123	125	136	119	135
105	177	416	548	557	538	497
115	340	560	826	1006	1031	755
125	502	652	947	1095	1156	788
135	646	721	966	1151	1214	727
145	769	804	953	1090	1144	596
155	866	882	920	996	1033	435
165	933	940	946	954	961	268
175	966	966	962	957	959	92
180	964	964	964	964	964	

KSD.3054.0301

### Photometric Reports

SERIES 10: PS - OPEN - 3 T8 - EP (ITL REPORT 50839)



90% Uplight  
10% Downlight



LEGEND:  
0-deg. - - - - -  
45-deg. - - - - -  
90-deg. ————

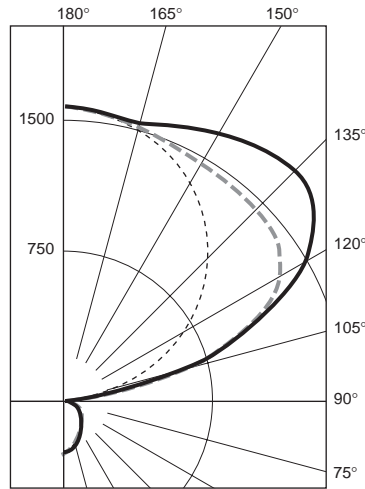

TOTAL LUMINAIRE EFFICIENCY = 81.2%

CANDELA DISTRIBUTION					FLUX	
	0.0	22.5	45.0	67.5	90.0	
0	303	303	303	303	303	
5	303	303	299	296	290	28
15	281	279	272	273	268	77
25	244	242	237	245	242	111
35	196	198	202	212	207	127
45	142	152	154	165	162	121
55	90	106	110	124	120	100
65	52	66	72	81	75	70
75	24	37	41	52	51	44
85	4	13	13	19	12	15
90	0	0	0	0	0	
95	54	125	123	136	128	139
105	290	585	627	594	549	589
115	559	828	1119	1247	1240	1007
125	814	979	1374	1559	1607	1143
135	1046	1125	1415	1673	1759	1084
145	1246	1277	1435	1598	1670	906
155	1400	1416	1450	1529	1573	680
165	1502	1512	1512	1515	1521	428
175	1556	1558	1552	1542	1543	148
180	1554	1554	1554	1554	1554	

#### ZONAL LUMEN SUMMARY

ZONE	LUMENS	%LAMP	%FIXT
0-30	217	2.6	3.2
0-40	344	4.1	5.0
0-60	564	6.7	8.3
0-90	693	8.3	10.2
90-120	1735	20.7	25.4
90-130	2877	34.3	42.2
90-150	4867	57.9	71.4
90-180	6123	72.9	89.8
0-180	6817	81.2	100.0

For layouts or additional photometry, contact your local representative or the factory.

### Photometric Reports

#### SERIES 10: PS - OPEN - 1 T8 - 91W (ITL REPORT 50823)

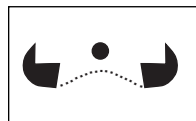

90% Uplight  
10% Downlight



LEGEND:  
0-deg. - - - - -  
45-deg. - - - - -  
90-deg. ————

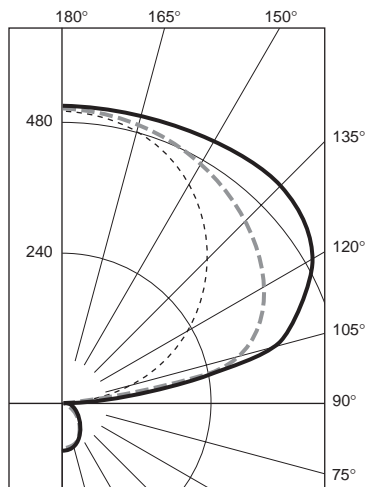

#### ZONAL LUMEN SUMMARY

ZONE	LUMENS	%LAMP	%FIXT
0-30	64	2.3	2.8
0-40	98	3.5	4.2
0-60	148	5.3	6.4
0-90	183	6.5	7.9
90-120	716	25.6	30.9
90-130	1079	38.6	46.6
90-150	1720	61.4	74.2
90-180	2136	76.3	92.1
0-180	2319	82.8	100.0

TOTAL LUMINAIRE EFFICIENCY = 82.8%

	CANDELA DISTRIBUTION					FLUX
	0.0	22.5	45.0	67.5	90.0	
0	88	88	88	88	88	
5	88	88	87	87	85	8
15	81	82	82	82	80	23
25	70	71	71	71	69	33
35	57	59	56	54	48	34
45	42	43	34	32	29	28
55	26	26	22	23	25	22
65	14	17	20	24	23	19
75	7	10	11	14	13	12
85	1	3	3	5	3	4
90	0	0	0	0	0	
95	15	88	91	100	90	90
105	91	199	287	356	376	279
115	179	267	372	445	465	348
125	263	326	420	488	511	363
135	339	381	454	512	530	344
145	404	428	476	517	533	296
155	455	465	491	513	523	227
165	488	492	499	506	510	141
175	506	506	505	502	503	48
180	504	504	504	504	504	

#### SERIES 10: PS - OPEN - 2 T8 - 91W (ITL REPORT 50824)

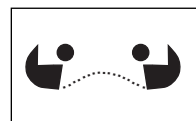

90% Uplight  
10% Downlight



LEGEND:  
0-deg. - - - - -  
45-deg. - - - - -  
90-deg. ————

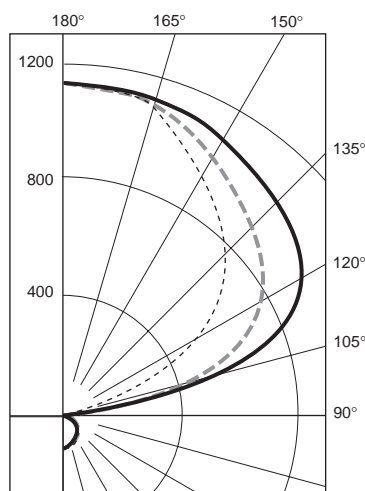

#### ZONAL LUMEN SUMMARY

ZONE	LUMENS	%LAMP	%FIXT
0-30	104	1.9	2.3
0-40	171	3.1	3.7
0-60	304	5.4	6.6
0-90	382	6.8	8.3
90-120	1296	23.1	28.0
90-130	2018	36.0	43.6
90-150	3340	59.6	72.2
90-180	4245	75.8	91.7
0-180	4627	82.6	100.0

TOTAL LUMINAIRE EFFICIENCY = 82.6%

	CANDELA DISTRIBUTION					FLUX
	0.0	22.5	45.0	67.5	90.0	
0	148	148	148	148	148	
5	148	148	144	142	138	14
15	137	133	128	128	126	37
25	119	113	114	121	124	54
35	94	93	105	119	122	67
45	67	75	93	108	110	71
55	43	59	73	85	83	62
65	28	38	43	51	50	43
75	13	20	26	33	33	26
85	1	8	8	11	7	9
90	0	0	0	0	0	
95	39	132	138	145	140	140
105	213	372	521	580	583	488
115	407	524	703	834	877	668
125	594	670	823	942	983	721
135	765	811	911	1006	1042	702
145	904	928	989	1047	1071	620
155	1016	1025	1054	1084	1095	488
165	1090	1093	1095	1102	1107	311
175	1128	1127	1123	1117	1118	107
180	1127	1127	1127	1127	1127	

KSID:3049.0301

### Photometric Reports

SERIES 10: PS - OPEN - 3 T8 - 91W (ITL REPORT 50825)



90% Uplight  
10% Downlight



LEGEND:  
0-deg. - - - - -  
45-deg. - - - - -  
90-deg. ————

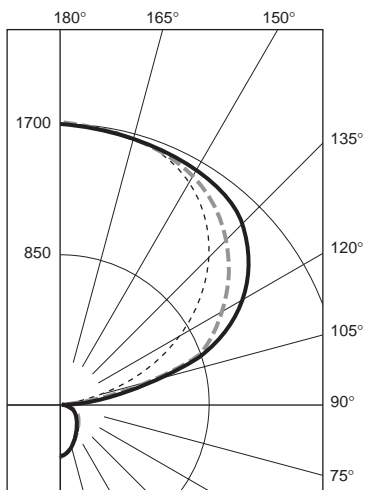

TOTAL LUMINAIRE EFFICIENCY = 80.2%

CANDELA DISTRIBUTION					FLUX	
	0.0	22.5	45.0	67.5	90.0	
0	306	306	306	306	306	
5	305	305	301	299	292	28
15	284	281	274	275	270	78
25	248	244	240	247	245	113
35	199	200	204	215	210	129
45	146	154	157	168	165	123
55	93	107	113	125	122	101
65	53	66	72	82	78	71
75	24	35	40	51	50	43
85	2	10	11	16	10	12
90	0	0	0	0	0	
95	56	141	128	138	117	144
105	324	536	579	597	586	571
115	622	775	983	1072	1074	909
125	909	1004	1213	1382	1409	1061
135	1165	1224	1353	1497	1547	1049
145	1381	1408	1485	1565	1599	932
155	1553	1562	1590	1632	1648	737
165	1666	1670	1666	1667	1672	472
175	1722	1724	1717	1705	1707	163
180	1719	1719	1719	1719	1719	

#### ZONAL LUMEN SUMMARY

ZONE	LUMENS	%LAMP	%FIXT
0-30	219	2.6	3.3
0-40	348	4.1	5.2
0-60	572	6.8	8.5
0-90	698	8.3	10.4
90-120	1624	19.3	24.1
90-130	2685	32.0	39.9
90-150	4666	55.5	69.3
90-180	6038	71.9	89.6
0-180	6736	80.2	100.0

For layouts or additional photometry, contact your local representative or the factory.

### Photometric Reports

#### SERIES 10: WCB - OPEN - 1 T8 - EP (ITL REPORT 50843)

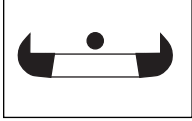

70% Uplight  
30% Downlight



LEGEND:  
0-deg. - - - - -  
45-deg. - - - - -  
90-deg. ————

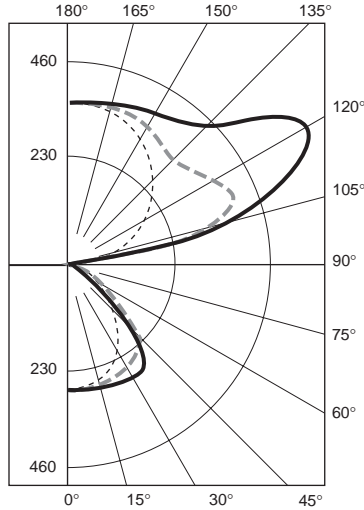

#### ZONAL LUMEN SUMMARY

ZONE	LUMENS	%LAMP	%FIXT
0-30	222	7.9	8.8
0-40	373	13.3	14.8
0-60	602	21.5	23.9
0-90	702	25.1	27.8
90-120	729	26.0	28.9
90-130	1056	37.7	41.8
90-150	1529	54.6	60.6
90-180	1820	65.0	72.2
0-180	2523	90.1	100.0

TOTAL LUMINAIRE EFFICIENCY = 90.1%

#### CANDELA DISTRIBUTION

	0.0	22.5	45.0	67.5	90.0	FLUX
0	281	281	281	281	281	
5	279	281	280	279	279	27
15	254	261	271	283	289	77
25	221	234	256	283	298	119
35	180	201	235	282	311	150
45	136	162	209	210	186	142
55	92	120	111	79	53	88
65	50	65	49	55	58	56
75	26	31	30	39	37	35
85	6	9	8	11	9	10
90	0	0	0	0	0	
95	18	77	86	97	87	87
105	76	200	315	352	342	278
115	142	205	410	528	550	363
125	197	236	355	501	548	327
135	248	276	328	405	437	263
145	289	308	337	363	376	211
155	320	330	347	358	364	159
165	341	343	349	355	355	99
175	349	349	349	347	348	33
180	348	348	348	348	348	

#### SERIES 10: WCB - OPEN - 2 T8 - EP (ITL REPORT 50844)

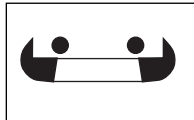

75% Uplight  
25% Downlight



LEGEND:  
0-deg. - - - - -  
45-deg. - - - - -  
90-deg. ————

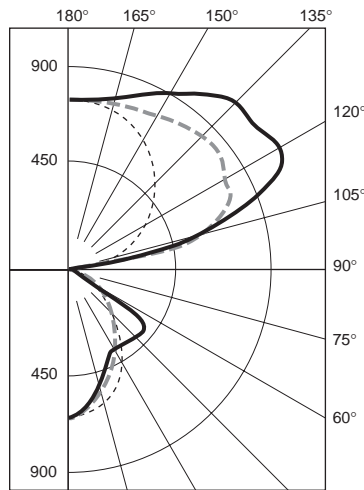

#### ZONAL LUMEN SUMMARY

ZONE	LUMENS	%LAMP	%FIXT
0-30	401	7.2	8.1
0-40	618	11.0	12.5
0-60	1064	19.0	21.5
0-90	1262	22.5	25.5
90-120	1298	23.2	26.2
90-130	1975	35.3	39.9
90-150	3067	54.8	61.9
90-180	3690	65.9	74.5
0-180	4952	88.4	100.0

TOTAL LUMINAIRE EFFICIENCY = 88.4%

#### CANDELA DISTRIBUTION

	0.0	22.5	45.0	67.5	90.0	FLUX
0	621	621	621	621	621	
5	615	616	608	605	599	57
15	561	553	525	508	497	149
25	485	462	411	389	381	195
35	396	357	302	339	367	217
45	299	253	263	331	377	228
55	197	167	222	316	379	218
65	97	104	142	146	138	127
75	49	50	51	56	55	56
85	11	14	14	15	14	15
90	0	0	0	0	0	
95	32	127	136	154	140	140
105	147	367	535	552	537	476
115	277	484	741	936	973	682
125	398	548	815	954	1018	677
135	507	588	811	972	1032	607
145	601	642	778	898	941	485
155	673	692	730	795	830	345
165	719	724	734	745	752	208
175	740	741	736	732	734	70
180	738	738	738	738	738	

KSID.3056.0301

### Photometric Reports

SERIES 10: WCB - OPEN - 3 T8 - EP (ITL REPORT 50845)



70% Uplight  
30% Downlight



LEGEND:  
0-deg. - - - - -  
45-deg. - - - - -  
90-deg. ————

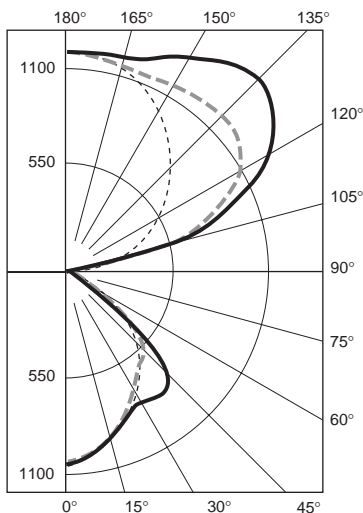

#### ZONAL LUMEN SUMMARY

ZONE	LUMENS	%LAMP	%FIXT
0-30	746	8.9	10.1
0-40	1193	14.2	16.1
0-60	1997	23.8	26.9
0-90	2334	27.8	31.4
90-120	1532	18.2	20.6
90-130	2495	29.7	33.6
90-150	4114	49.0	55.4
90-180	5088	60.6	68.6
0-180	7422	88.4	100.0

TOTAL LUMINAIRE EFFICIENCY = 88.4%

CANDELA DISTRIBUTION					FLUX
0.0	22.5	45.0	67.5	90.0	
0	1059	1059	1059	1059	1059
5	1049	1050	1044	1039	1034 99
15	960	956	945	945	943 268
25	835	825	807	824	839 380
35	686	669	667	761	831 447
45	518	507	583	636	670 447
55	346	349	401	442	473 357
65	178	197	216	211	195 205
75	89	94	97	108	108 105
85	19	24	23	27	26 27
90	0	0	0	0	0
95	44	115	113	126	114 127
105	221	508	566	539	508 525
115	423	686	995	1130	1136 880
125	614	801	1152	1349	1405 962
135	788	895	1178	1395	1471 889
145	939	1002	1169	1321	1381 730
155	1058	1090	1144	1223	1265 535
165	1135	1144	1163	1178	1188 329
175	1170	1172	1167	1161	1163 111
180	1168	1168	1168	1168	1168

For layouts or additional photometry, contact your local representative or the factory.

### Photometric Reports

#### SERIES 10: WCB - OPEN - 1 T8 - 91W (ITL REPORT 50799)

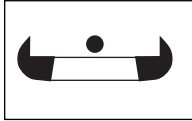

70% Uplight  
30% Downlight



LEGEND:  
0-deg. - - - - -  
45-deg. - - - - -  
90-deg. ————

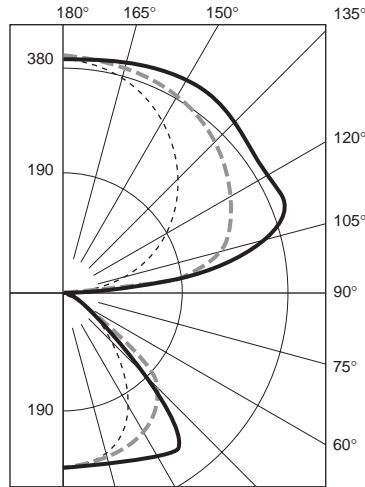

TOTAL LUMINAIRE EFFICIENCY = 89.4%

CANDELA DISTRIBUTION						FLUX
	0.0	22.5	45.0	67.5	90.0	
0	287	287	287	287	287	
5	285	286	285	285	284	27
15	260	266	276	287	293	78
25	226	239	261	288	304	122
35	186	205	241	288	318	154
45	141	166	215	217	196	147
55	96	124	117	82	56	92
65	54	68	52	58	65	59
75	28	32	32	40	39	36
85	6	9	8	11	9	10
90	0	0	0	0	0	
95	17	96	91	124	91	100
105	83	168	265	343	359	260
115	158	219	304	377	401	292
125	222	267	334	387	401	291
135	278	310	362	402	412	274
145	326	345	377	406	418	235
155	361	370	387	401	408	178
165	382	386	390	394	397	110
175	392	393	392	390	390	37
180	392	392	392	392	392	

#### ZONAL LUMEN SUMMARY

ZONE	LUMENS	%LAMP	%FIXT
0-30	227	8.1	9.1
0-40	381	13.6	15.2
0-60	619	22.1	24.7
0-90	724	25.9	28.9
90-120	652	23.3	26.0
90-130	943	33.7	37.7
90-150	1453	51.9	58.0
90-180	1779	63.5	71.1
0-180	2503	89.4	100.0

#### SERIES 10: WCB - OPEN - 2 T8 - 91W (ITL REPORT 50800)



75% Uplight  
25% Downlight



LEGEND:  
0-deg. - - - - -  
45-deg. - - - - -  
90-deg. ————

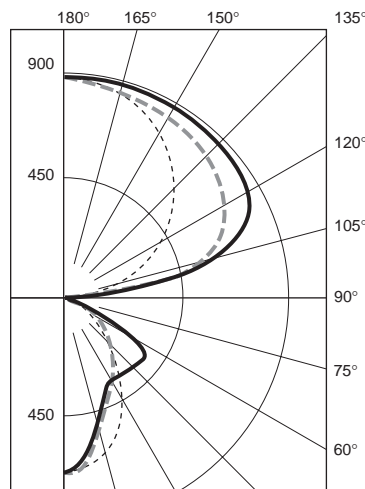

TOTAL LUMINAIRE EFFICIENCY = 87.4%

CANDELA DISTRIBUTION						FLUX
	0.0	22.5	45.0	67.5	90.0	
0	618	618	618	618	618	
5	613	612	606	603	598	57
15	559	551	522	506	497	148
25	486	461	409	387	378	195
35	397	357	303	342	370	218
45	302	254	267	334	381	230
55	199	169	225	319	385	221
65	100	107	144	151	147	132
75	49	51	52	58	58	57
85	10	14	14	15	14	16
90	0	0	0	0	0	
95	35	131	133	147	125	138
105	172	330	491	560	555	455
115	332	452	626	765	811	596
125	474	560	700	818	858	614
135	606	667	758	844	874	583
145	718	760	811	861	881	507
155	802	825	855	878	887	393
165	857	865	877	885	893	248
175	884	884	881	877	879	84
180	882	882	882	882	882	

#### ZONAL LUMEN SUMMARY

ZONE	LUMENS	%LAMP	%FIXT
0-30	400	7.1	8.2
0-40	618	11.0	12.6
0-60	1070	19.1	21.9
0-90	1275	22.8	26.1
90-120	1188	21.2	24.3
90-130	1803	32.2	36.8
90-150	2892	51.6	59.1
90-180	3617	64.6	73.9
0-180	4892	87.4	100.0

### Photometric Reports

SERIES 10: WCB - OPEN - 3 T8 - 91W (ITL REPORT 50801)



70% Uplight  
30% Downlight



LEGEND:  
0-deg. - - - - -  
45-deg. - - - - -  
90-deg. ————

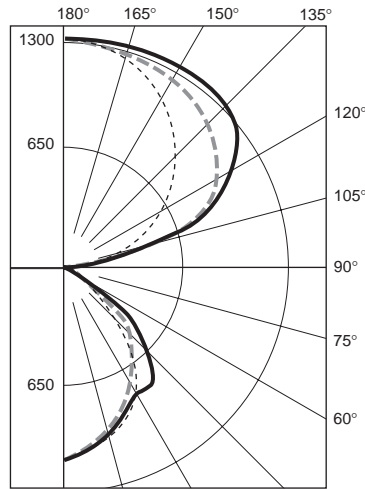

TOTAL LUMINAIRE EFFICIENCY = 88.5%

CANDELA DISTRIBUTION					FLUX
	0.0	22.5	45.0	67.5	90.0
0	1072	1072	1072	1072	1072
5	1067	1064	1056	1051	1045
15	974	968	951	952	949
25	848	833	814	832	846
35	700	678	674	769	840
45	534	514	590	645	677
55	359	360	411	451	487
65	182	205	224	219	206
75	92	98	101	112	113
85	23	28	27	32	30
90	0	0	0	0	0
95	47	130	123	137	120
105	250	465	537	559	545
115	482	655	875	967	980
125	704	825	1038	1204	1237
135	901	984	1143	1272	1317
145	1071	1119	1209	1302	1340
155	1199	1221	1270	1310	1327
165	1285	1288	1301	1315	1324
175	1326	1326	1318	1311	1312
180	1322	1322	1322	1322	1322

#### ZONAL LUMEN SUMMARY

ZONE	LUMENS	%LAMP	%FIXT
0-30	753	9.0	10.1
0-40	1206	14.4	16.2
0-60	2026	24.1	27.2
0-90	2379	28.3	32.0
90-120	1448	17.2	19.5
90-130	2349	28.0	31.6
90-150	3978	47.4	53.5
90-180	5057	60.2	68.0
0-180	7436	88.5	100.0

For layouts or additional photometry, contact your local representative or the factory.

### Photometric Reports

#### SERIES 10: WCB - CCO - 1 T8 - 91W (ITL REPORT 50802)

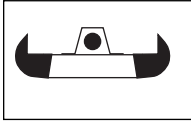

10% Uplight  
90% Downlight



LEGEND:  
0-deg. - - - - -  
45-deg. - - - - -  
90-deg. ————

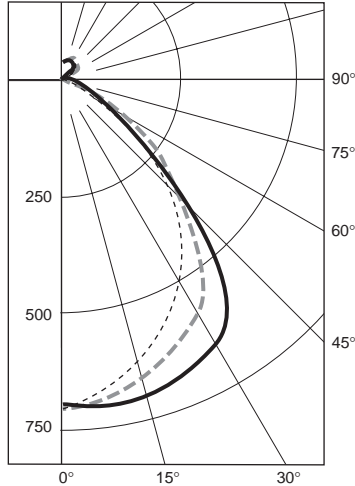

#### ZONAL LUMEN SUMMARY

ZONE	LUMENS	%LAMP	%FIXT
0-30	536	19.1	30.8
0-40	872	31.2	50.1
0-60	1393	49.7	79.9
0-90	1574	56.2	90.3
90-120	50	1.8	2.9
90-130	82	2.9	4.7
90-150	137	4.9	7.9
90-180	169	6.0	9.7
0-180	1743	62.3	100.0

TOTAL LUMINAIRE EFFICIENCY = 62.3%

	CANDELA DISTRIBUTION					FLUX
	0.0	22.5	45.0	67.5	90.0	
0	689	689	689	689	689	
5	688	686	687	684	683	65
15	628	638	661	683	695	187
25	550	572	617	661	684	284
35	454	488	541	590	621	336
45	345	389	430	415	410	310
55	230	270	252	208	192	210
65	111	130	110	77	63	105
75	57	60	55	54	52	59
85	15	16	14	16	15	17
90	0	0	0	0	0	
95	5	2	1	1	1	3
105	26	28	9	8	6	17
115	45	36	35	23	17	31
125	46	44	34	28	21	31
135	44	46	39	30	25	29
145	41	44	48	41	35	27
155	37	39	43	44	45	19
165	31	31	36	36	38	10
175	27	27	27	27	28	3
180	27	27	27	27	27	

#### SERIES 10: WCB - CCO - 2 T8 - 91W (ITL REPORT 50803)

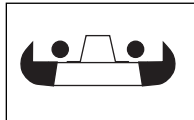

75% Uplight  
25% Downlight



LEGEND:  
0-deg. - - - - -  
45-deg. - - - - -  
90-deg. ————

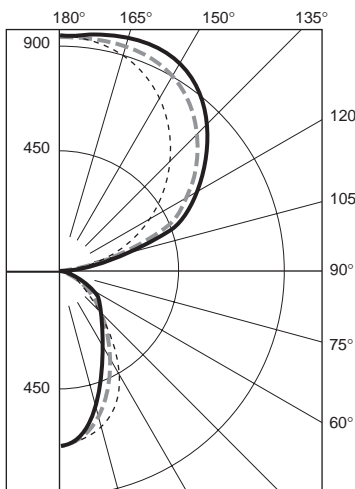

#### ZONAL LUMEN SUMMARY

ZONE	LUMENS	%LAMP	%FIXT
0-30	430	7.7	9.7
0-40	647	11.6	14.5
0-60	1008	18.0	22.7
0-90	1176	21.0	26.4
90-120	833	14.9	18.7
90-130	1381	24.7	31.1
90-150	2489	44.4	56.0
90-180	3271	58.4	73.6
0-180	4448	79.4	100.0

TOTAL LUMINAIRE EFFICIENCY = 79.4%

	CANDELA DISTRIBUTION					FLUX
	0.0	22.5	45.0	67.5	90.0	
0	665	665	665	665	665	
5	658	657	653	651	646	62
15	598	592	566	550	539	160
25	516	493	439	417	409	209
35	418	377	317	319	322	217
45	310	262	232	247	264	199
55	200	164	164	190	211	162
65	87	87	103	135	129	106
75	42	44	45	49	49	49
85	10	12	12	13	12	14
90	0	2	5	5	6	
95	30	71	65	69	62	75
105	162	266	309	310	298	294
115	321	423	481	541	558	465
125	475	580	626	666	677	548
135	621	712	762	791	798	574
145	745	811	875	899	902	533
155	845	882	930	964	975	425
165	909	923	946	964	973	267
175	943	944	942	938	941	90
180	941	941	941	941	941	

KSD30420301

### Photometric Reports

SERIES 10: WCB - CCO - 3 T8 - 91W (ITL REPORT 50804)

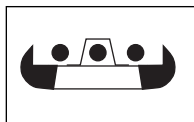

55% Uplight  
45% Downlight



LEGEND:  
0-deg. - - - - -  
45-deg. - - - - -  
90-deg. ————

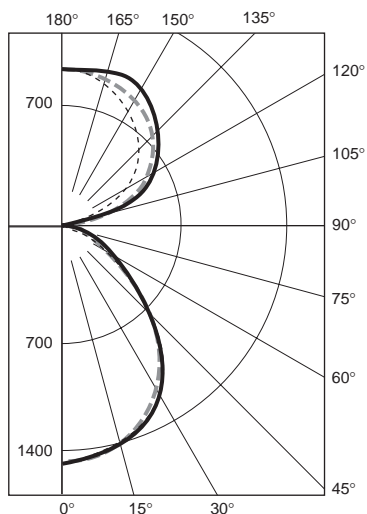

#### ZONAL LUMEN SUMMARY

ZONE	LUMENS	%LAMP	%FIXT
0-30	1037	12.3	16.7
0-40	1623	19.3	26.2
0-60	2537	30.2	40.9
0-90	2900	34.5	46.8
90-120	857	10.2	13.8
90-130	1411	16.8	22.8
90-150	2520	30.0	40.6
90-180	3303	39.3	53.2
0-180	6202	73.8	100.0

TOTAL LUMINAIRE EFFICIENCY = 73.8%

	CANDELA DISTRIBUTION					FLUX
	0.0	22.5	45.0	67.5	90.0	
0	1464	1464	1464	1464	1464	
5	1454	1454	1451	1444	1439	137
15	1326	1330	1320	1320	1320	373
25	1146	1143	1124	1146	1162	527
35	941	925	911	949	986	586
45	704	694	690	683	683	532
55	461	458	429	397	391	382
65	208	230	215	210	195	216
75	104	110	107	110	109	115
85	25	30	28	30	29	32
90	0	3	3	4	4	
95	31	76	66	73	67	77
105	169	276	316	326	309	304
115	328	426	498	554	565	476
125	487	582	634	678	688	555
135	633	711	760	793	799	576
145	756	810	872	895	896	533
155	855	884	928	960	971	425
165	920	929	947	963	971	267
175	949	949	947	943	945	90
180	948	948	948	948	948	

For layouts or additional photometry, contact your local representative or the factory.

### Photometric Reports

#### SERIES 10: WCB - STO - 1 T8 - 91W (ITL REPORT 50805)

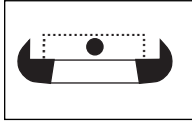

30% Uplight  
70% Downlight



LEGEND:  
0-deg. - - - - -  
45-deg. - - - - -  
90-deg. ————

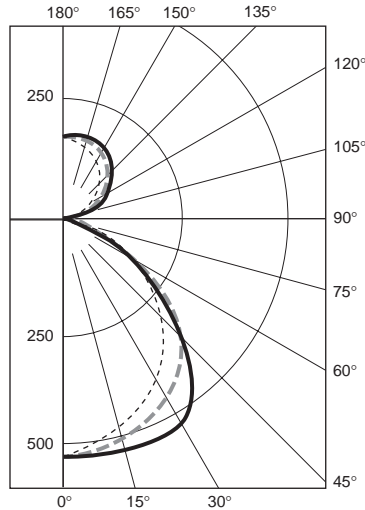

#### ZONAL LUMEN SUMMARY

ZONE	LUMENS	%LAMP	%FIXT
0-30	416	14.8	22.4
0-40	684	24.4	36.9
0-60	1123	40.1	60.5
0-90	1318	47.1	71.1
90-120	120	4.3	6.5
90-130	208	7.4	11.2
90-150	401	14.3	21.6
90-180	537	19.2	28.9
0-180	1855	66.3	100.0

TOTAL LUMINAIRE EFFICIENCY = 66.3%

#### CANDELA DISTRIBUTION

	0.0	22.5	45.0	67.5	90.0	FLUX
0	526	526	526	526	526	
5	525	526	527	526	526	50
15	484	492	506	524	533	144
25	429	444	477	515	536	222
35	359	385	431	472	494	268
45	280	314	348	345	343	254
55	195	232	214	187	180	185
65	103	120	111	123	130	117
75	51	55	56	64	66	62
85	11	14	13	16	15	16
90	0	1	2	2	3	
95	3	8	12	23	20	16
105	21	33	36	54	62	43
115	47	60	61	67	65	62
125	79	92	102	111	105	88
135	107	118	132	142	140	99
145	132	139	150	160	162	93
155	150	153	159	167	169	74
165	161	162	164	167	168	46
175	166	166	166	165	164	16
180	166	166	166	166	166	

#### SERIES 10: WCB - STO - 2 T8 - 91W (ITL REPORT 50806)

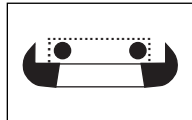

35% Uplight  
65% Downlight



LEGEND:  
0-deg. - - - - -  
45-deg. - - - - -  
90-deg. ————

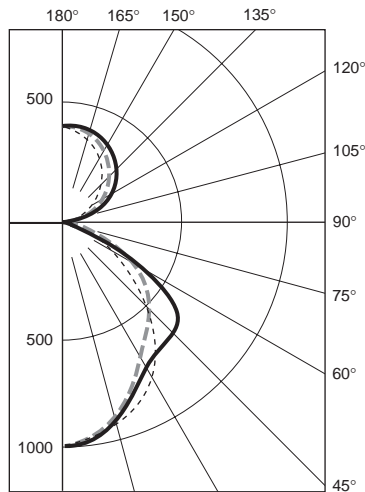

#### ZONAL LUMEN SUMMARY

ZONE	LUMENS	%LAMP	%FIXT
0-30	697	12.4	19.7
0-40	1110	19.8	31.4
0-60	1935	34.6	54.8
0-90	2282	40.8	64.6
90-120	280	5.0	7.9
90-130	488	8.7	13.8
90-150	928	16.6	26.3
90-180	1251	22.3	35.4
0-180	3533	63.1	100.0

TOTAL LUMINAIRE EFFICIENCY = 63.1%

#### CANDELA DISTRIBUTION

	0.0	22.5	45.0	67.5	90.0	FLUX
0	996	996	996	996	996	
5	989	988	982	977	972	93
15	910	905	881	875	871	250
25	801	783	750	753	758	353
35	669	639	617	682	730	414
45	516	488	529	635	704	437
55	355	345	421	519	576	388
65	181	194	236	249	249	224
75	88	90	90	97	98	99
85	19	22	20	23	23	25
90	0	1	3	6	7	
95	7	17	25	34	33	28
105	50	73	91	113	120	96
115	105	135	155	184	195	156
125	177	202	239	264	267	208
135	248	267	300	328	331	228
145	306	316	344	362	368	213
155	354	360	375	387	392	172
165	389	391	393	397	400	111
175	405	407	406	404	404	39
180	405	405	405	405	405	

### Photometric Reports

SERIES 10: WCB - STO - 3 T8 - 91W (ITL REPORT 50807)

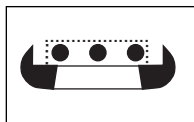

30% Uplight  
70% Downlight



LEGEND:  
0-deg. - - - - -  
45-deg. - - - - -  
90-deg. ————

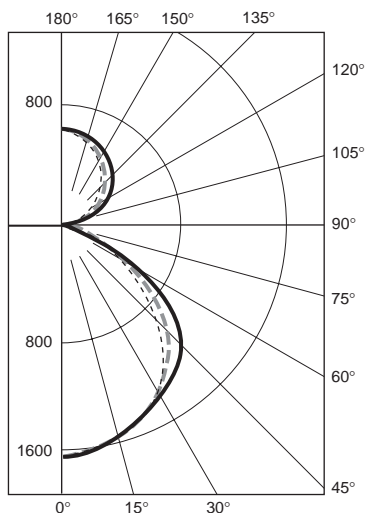

#### ZONAL LUMEN SUMMARY

ZONE	LUMENS	%LAMP	%FIXT
0-30	1207	14.4	22.2
0-40	1933	23.0	35.5
0-60	3198	38.1	58.7
0-90	3722	44.3	68.3
90-120	342	4.1	6.3
90-130	623	7.4	11.4
90-150	1254	14.9	23.0
90-180	1729	20.6	31.7
0-180	5451	64.9	100

TOTAL LUMINAIRE EFFICIENCY = 64.9%

CANDELA DISTRIBUTION					FLUX
	0.0	22.5	45.0	67.5	90.0
0	1655	1655	1655	1655	1655
5	1648	1646	1638	1630	1625 155
15	1515	1517	1514	1522	1530 429
25	1328	1327	1333	1377	1409 624
35	1103	1101	1130	1221	1282 726
45	850	856	909	956	996 704
55	577	596	610	662	705 561
65	283	310	334	333	320 322
75	140	147	146	157	156 158
85	32	39	36	42	39 43
90	0	2	4	4	4
95	9	20	28	42	43 32
105	62	90	108	133	133 114
115	141	175	194	224	234 197
125	248	279	323	358	356 281
135	351	379	422	459	465 322
145	445	461	497	526	536 309
155	522	529	549	569	575 253
165	576	578	579	588	590 165
175	603	605	602	598	599 57
180	603	603	603	603	603

For layouts or additional photometry, contact your local representative or the factory.

### Photometric Reports

#### SERIES 10: WCB - TDO - 1 T8 - 91W (ITL REPORT 50808)

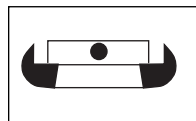

100% Downlight



LEGEND:  
 0-deg. - - - - -  
 45-deg. - - - - -  
 90-deg. ————

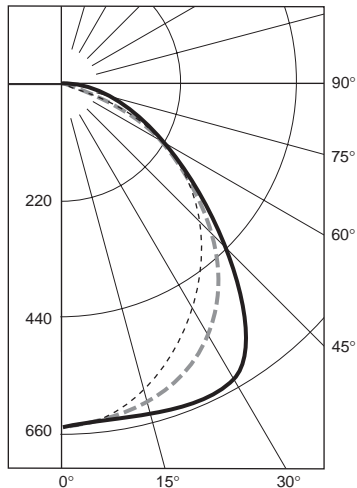

TOTAL LUMINAIRE EFFICIENCY = 57.2%

CANDELA DISTRIBUTION						FLUX
	0.0	22.5	45.0	67.5	90.0	
0	648	648	648	648	648	
5	644	646	646	644	645	61
15	595	603	621	641	651	176
25	525	543	581	626	651	270
35	435	466	521	563	583	321
45	339	378	410	411	412	304
55	234	272	259	247	250	230
65	124	139	141	161	170	146
75	62	66	67	77	79	74
85	14	16	16	19	18	19
90	0	0	0	0	0	

#### ZONAL LUMEN SUMMARY

ZONE	LUMENS	%LAMP	%FIXT
0-30	507	18.1	31.7
0-40	828	29.6	51.7
0-60	1361	48.6	85.0
0-90	1601	57.2	100.0
90-180	0	0.0	0.0
0-180	1601	57.2	100.0

#### SERIES 10: WCB - TDO - 2 T8 - 91W (ITL REPORT 50809)

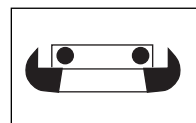

100% Downlight



LEGEND:  
 0-deg. - - - - -  
 45-deg. - - - - -  
 90-deg. ————

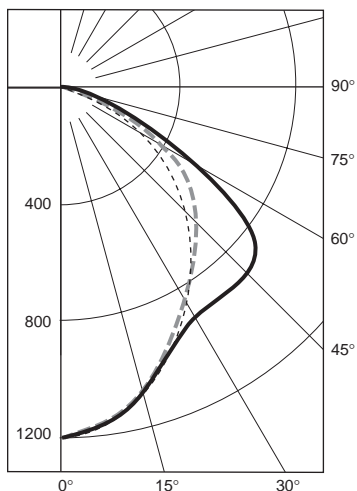

TOTAL LUMINAIRE EFFICIENCY = 50.1%

CANDELA DISTRIBUTION						FLUX
	0.0	22.5	45.0	67.5	90.0	
0	1190	1190	1190	1190	1190	
5	1181	1182	1177	1171	1166	111
15	1088	1085	1065	1064	1065	302
25	959	945	921	939	954	433
35	795	778	770	855	917	511
45	617	598	658	791	883	539
55	424	423	521	633	681	473
65	219	245	285	308	316	278
75	109	114	112	122	121	123
85	27	30	28	33	30	33
90	0	0	0	0	0	

#### ZONAL LUMEN SUMMARY

ZONE	LUMENS	%LAMP	%FIXT
0-30	846	15.1	30.2
0-40	1357	24.2	48.4
0-60	2368	42.3	84.5
0-90	2803	50.1	100.0
90-180	0	0.0	0.0
0-180	2803	50.1	100.0

KSID3044-0301

### Photometric Reports

SERIES 10: WCB - TDO - 3 T8 - 91W (ITL REPORT 50810)

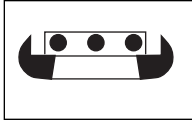

100% Downlight



LEGEND:  
 0-deg. - - - - -  
 45-deg. - - - - -  
 90-deg. ————

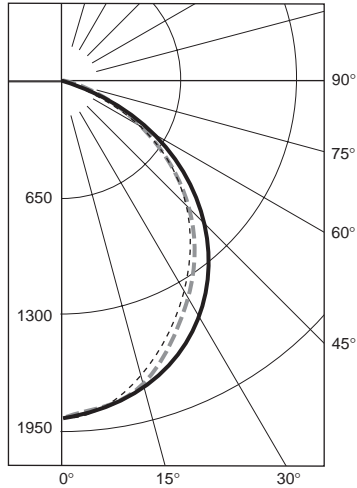

TOTAL LUMINAIRE EFFICIENCY = 51.0%

CANDELA DISTRIBUTION					FLUX	
	0.0	22.5	45.0	67.5	90.0	
0	1900	1900	1900	1900	1900	
5	1888	1890	1886	1877	1876	179
15	1735	1747	1748	1765	1780	495
25	1520	1530	1549	1615	1662	725
35	1262	1273	1323	1419	1481	841
45	969	992	1046	1092	1137	808
55	656	688	697	751	811	640
65	322	354	379	390	390	372
75	163	167	165	177	175	179
85	40	44	40	47	45	48
90	0	0	0	0	0	

#### ZONAL LUMEN SUMMARY

ZONE	LUMENS	%LAMP	%FIXT
0-30	1399	16.7	32.6
0-40	2239	26.7	52.2
0-60	3687	43.9	86.0
0-90	4286	51.0	100.0
90-180	0	0.0	0.0
0-180	4286	51.0	100.0

For layouts or additional photometry, contact your local representative or the factory.

### Photometric Reports

#### SERIES 10: PLV - OPEN - 1 T8 - EP (ITL REPORT 50831)

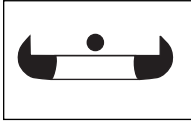

70% Uplight  
30% Downlight



LEGEND:  
0-deg. - - - - -  
45-deg. - - - - -  
90-deg. ————

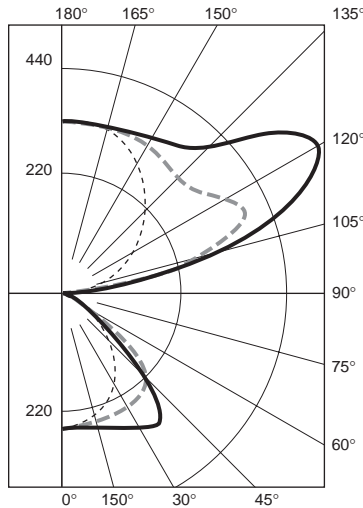

#### ZONAL LUMEN SUMMARY

ZONE	LUMENS	%LAMP	%FIXT
0-30	218	7.8	9.4
0-40	368	13.1	15.9
0-60	597	21.3	25.8
0-90	660	23.6	28.5
90-120	664	23.7	28.7
90-130	958	34.2	41.4
90-150	1384	49.4	59.8
90-180	1656	59.1	71.5
0-180	2316	82.7	100.0

TOTAL LUMINAIRE EFFICIENCY = 82.7%

#### CANDELA DISTRIBUTION

	0.0	22.5	45.0	67.5	90.0	FLUX
0	273	273	273	273	273	
5	272	272	271	271	270	26
15	247	252	264	276	283	75
25	213	225	252	281	297	117
35	172	193	236	286	320	150
45	127	155	210	214	212	144
55	81	110	111	76	65	85
65	34	48	30	41	51	40
75	13	15	13	21	26	18
85	2	3	4	5	6	4
90	0	0	0	0	0	
95	9	70	77	85	74	76
105	49	173	290	330	325	256
115	99	167	377	500	521	332
125	156	198	312	463	520	294
135	208	240	292	368	401	234
145	253	276	306	335	350	192
155	290	303	323	336	343	148
165	316	320	328	335	339	93
175	328	330	330	328	328	31
180	328	328	328	328	328	

#### SERIES 10: PLV - OPEN - 2 T8 - EP (ITL REPORT 50832)

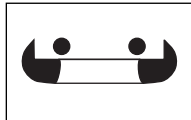

75% Uplight  
25% Downlight



LEGEND:  
0-deg. - - - - -  
45-deg. - - - - -  
90-deg. ————

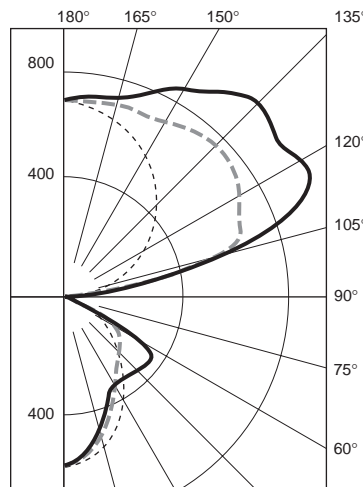

#### ZONAL LUMEN SUMMARY

ZONE	LUMENS	%LAMP	%FIXT
0-30	371	6.6	8.2
0-40	574	10.3	12.7
0-60	988	17.6	21.9
0-90	1130	20.2	25.0
90-120	1182	21.1	26.1
90-130	1795	32.1	39.7
90-150	2805	50.1	62.0
90-180	3391	60.6	75.0
0-180	4521	80.7	100.0

TOTAL LUMINAIRE EFFICIENCY = 80.7%

#### CANDELA DISTRIBUTION

	0.0	22.5	45.0	67.5	90.0	FLUX
0	574	574	574	574	574	
5	569	568	562	558	553	53
15	519	509	482	472	463	137
25	449	422	378	362	359	181
35	367	325	283	326	356	203
45	273	225	246	317	367	214
55	170	138	203	298	362	200
65	69	74	114	121	118	102
75	25	26	25	33	41	32
85	5	6	6	9	11	8
90	0	0	0	0	0	
95	41	112	118	133	117	125
105	122	331	494	517	501	436
115	226	421	670	869	908	620
125	340	486	732	876	937	613
135	444	535	746	903	965	558
145	537	585	730	850	894	452
155	612	640	689	760	799	325
165	664	673	694	709	717	196
175	689	688	691	689	691	66
180	690	690	690	690	690	

### Photometric Reports

SERIES 10: PLV - OPEN - 3 T8 - EP (ITL REPORT 50833)

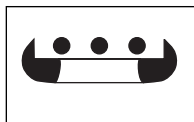

70% Uplight  
30% Downlight



LEGEND:  
0-deg. - - - - -  
45-deg. - - - - -  
90-deg. ————

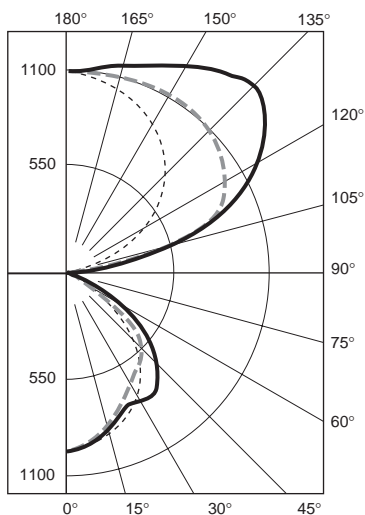

#### ZONAL LUMEN SUMMARY

ZONE	LUMENS	%LAMP	%FIXT
0-30	698	8.3	10.2
0-40	1119	13.3	16.3
0-60	1858	22.1	27.1
0-90	2076	24.7	30.2
90-120	1457	17.3	21.2
90-130	2351	28.0	34.2
90-150	3869	46.1	56.3
90-180	4793	57.1	69.8
0-180	6869	81.8	100.0

TOTAL LUMINAIRE EFFICIENCY = 81.8%

CANDELA DISTRIBUTION					FLUX	
	0.0	22.5	45.0	67.5	90.0	
0	988	988	988	988	988	
5	978	980	974	970	965	92
15	894	892	881	884	882	250
25	779	768	754	779	798	356
35	639	619	627	726	800	421
45	479	461	544	605	648	419
55	302	304	357	407	455	321
65	119	141	155	157	158	151
75	46	47	41	56	69	54
85	7	9	10	15	17	13
90	0	0	0	0	0	
95	32	114	111	126	113	123
105	177	464	566	533	507	506
115	355	619	932	1091	1111	828
125	539	736	1067	1267	1331	894
135	715	827	1105	1308	1384	829
145	869	931	1104	1261	1321	689
155	990	1020	1082	1169	1215	506
165	1073	1081	1101	1122	1134	312
175	1114	1115	1111	1106	1109	106
180	1113	1113	1113	1113	1113	

For layouts or additional photometry, contact your local representative or the factory.

### Photometric Reports

#### SERIES 10: PLV - OPEN - 1 T8 - 91W (ITL REPORT 50811)

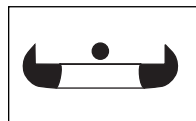

70% Uplight  
30% Downlight



LEGEND:  
0-deg. - - - - -  
45-deg. - - - - -  
90-deg. ————

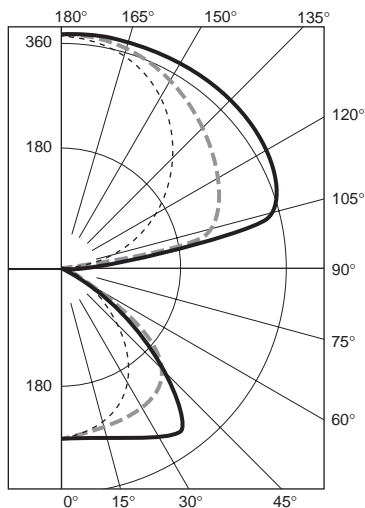

#### ZONAL LUMEN SUMMARY

ZONE	LUMENS	%LAMP	%FIXT
0-30	221	7.9	9.7
0-40	375	13.4	16.4
0-60	609	21.8	26.7
0-90	678	24.2	29.7
90-120	580	20.7	25.4
90-130	841	30.0	36.8
90-150	1300	46.4	57.0
90-180	1605	57.3	70.3
0-180	2283	81.5	100.0

TOTAL LUMINAIRE EFFICIENCY = 81.5%

CANDELA DISTRIBUTION					FLUX	
	0.0	22.5	45.0	67.5	90.0	
0	277	277	277	277	277	
5	274	276	275	275	274	26
15	250	255	267	280	287	76
25	215	230	256	286	304	119
35	175	198	241	293	327	153
45	129	160	214	227	212	147
55	81	115	109	84	68	87
65	33	53	31	46	57	44
75	13	16	14	23	27	20
85	2	4	4	6	6	5
90	0	0	0	0	0	
95	9	85	76	107	75	84
105	54	142	244	324	342	235
115	114	181	275	352	375	261
125	177	227	297	360	383	261
135	236	271	322	368	384	246
145	287	310	343	374	387	214
155	328	340	358	375	384	165
165	356	360	366	372	376	104
175	371	372	371	369	369	35
180	371	371	371	371	371	

#### SERIES 10: PLV - OPEN - 2 T8 - 91W (ITL REPORT 50812)

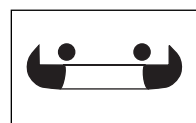

75% Uplight  
25% Downlight



LEGEND:  
0-deg. - - - - -  
45-deg. - - - - -  
90-deg. ————

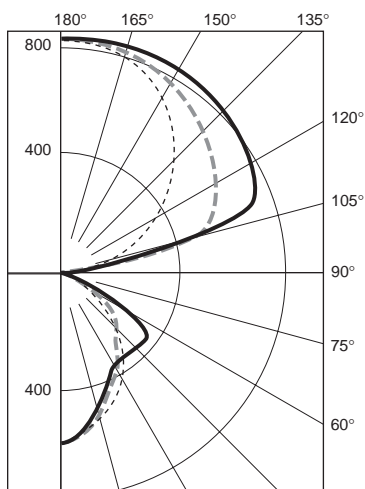

#### ZONAL LUMEN SUMMARY

ZONE	LUMENS	%LAMP	%FIXT
0-30	388	6.9	8.6
0-40	597	10.7	13.3
0-60	1021	18.2	22.6
0-90	1169	20.9	25.9
90-120	1090	19.5	24.2
90-130	1647	29.4	36.5
90-150	2656	47.4	58.9
90-180	3338	59.6	74.1
0-180	4508	80.5	100.0

TOTAL LUMINAIRE EFFICIENCY = 80.5%

CANDELA DISTRIBUTION					FLUX	
	0.0	22.5	45.0	67.5	90.0	
0	599	599	599	599	599	
5	596	595	589	585	580	56
15	544	534	509	495	486	144
25	470	444	396	378	373	189
35	384	339	290	330	358	209
45	286	234	250	322	372	219
55	178	142	208	304	371	204
65	73	75	119	126	128	107
75	27	27	26	34	44	34
85	5	7	6	9	11	8
90	0	0	0	0	0	
95	22	122	126	135	127	127
105	132	287	465	541	539	423
115	269	391	564	710	761	540
125	412	499	638	751	792	557
135	541	605	701	789	821	537
145	654	694	758	816	838	473
155	745	764	802	834	846	369
165	805	811	824	839	845	233
175	837	838	834	831	832	79
180	837	837	837	837	837	

KSID:3045:0301

### Photometric Reports

SERIES 10: PLV - OPEN - 3 T8 - 91W (ITL REPORT 50813)

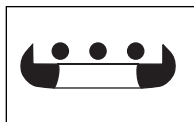

70% Uplight  
30% Downlight



LEGEND:  
0-deg. - - - - -  
45-deg. - - - - -  
90-deg. ————

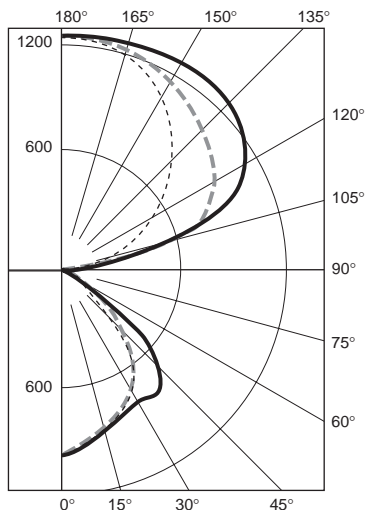

#### ZONAL LUMEN SUMMARY

ZONE	LUMENS	%LAMP	%FIXT
0-30	701	8.3	10.3
0-40	1126	13.4	16.5
0-60	1873	22.3	27.4
0-90	2093	24.9	30.6
90-120	1359	16.2	19.9
90-130	2198	26.2	32.2
90-150	3717	44.3	54.4
90-180	4736	56.4	69.4
0-180	6829	81.3	100.0

TOTAL LUMINAIRE EFFICIENCY = 81.3%

CANDELA DISTRIBUTION					FLUX
0.0	22.5	45.0	67.5	90.0	
0	993	993	993	993	993
5	981	983	977	973	968 92
15	896	894	883	887	886 251
25	783	770	760	785	805 358
35	641	622	633	732	808 424
45	479	467	550	611	653 423
55	305	307	356	410	463 324
65	120	141	154	161	164 155
75	47	47	41	57	71 54
85	6	8	8	13	15 12
90	0	0	0	0	0
95	33	121	117	126	114 126
105	200	426	517	542	525 487
115	407	590	825	931	951 746
125	617	751	966	1145	1186 840
135	812	904	1060	1194	1246 809
145	979	1036	1135	1230	1266 710
155	1115	1141	1197	1246	1266 552
165	1209	1213	1230	1249	1259 349
175	1254	1253	1246	1240	1242 119
180	1252	1252	1252	1252	1252

For layouts or additional photometry, contact your local representative or the factory.

### Photometric Reports

#### SERIES 10: PLV - CCO - 1 T8 - EP (ITL REPORT 50834)

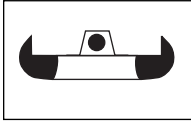

5% Uplight  
95% Downlight



LEGEND:  
0-deg. - - - - -  
45-deg. - - - - -  
90-deg. ————

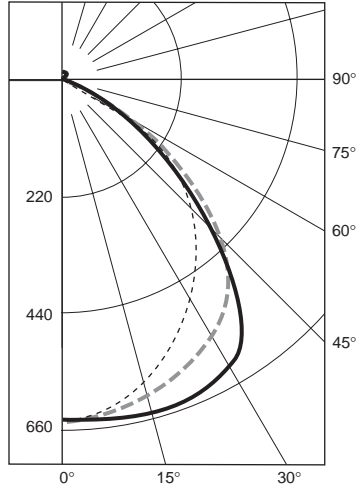

#### ZONAL LUMEN SUMMARY

ZONE	LUMENS	%LAMP	%FIXT
0-30	505	18.1	34.1
0-40	825	29.4	55.7
0-60	1313	46.9	88.7
0-90	1430	51.1	96.5
90-120	14	0.5	1.0
90-130	24	0.9	1.6
90-150	41	1.5	2.8
90-180	52	1.8	3.5
0-180	1481	52.9	100.0

TOTAL LUMINAIRE EFFICIENCY = 52.9%

#### CANDELA DISTRIBUTION

	0.0	22.5	45.0	67.5	90.0	FLUX
0	646	646	646	646	646	
5	641	643	644	642	644	61
15	590	600	622	642	654	176
25	520	543	582	623	644	268
35	434	467	512	555	589	319
45	331	375	403	390	394	294
55	216	253	221	190	189	194
65	87	105	69	55	59	79
75	32	31	21	29	37	30
85	5	5	5	8	9	7
90	0	0	0	0	0	
95	2	2	1	1	1	2
105	4	12	3	2	2	5
115	6	9	12	7	4	8
125	7	8	14	14	11	10
135	9	10	12	16	16	10
145	10	11	11	13	14	8
155	11	12	13	13	13	6
165	11	11	13	13	13	3
175	11	12	11	11	11	1
180	11	11	11	11	11	

#### SERIES 10: PLV - CCO - 2 T8 - EP (ITL REPORT 50835)

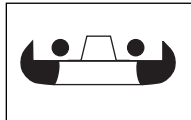

75% Uplight  
25% Downlight



LEGEND:  
0-deg. - - - - -  
45-deg. - - - - -  
90-deg. ————

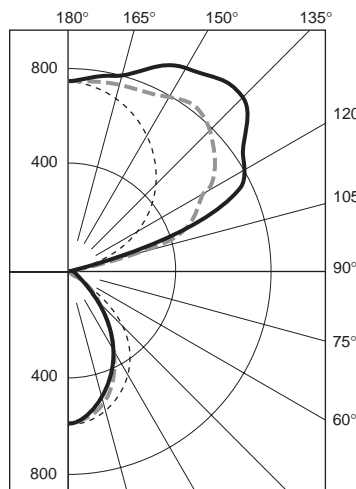

#### ZONAL LUMEN SUMMARY

ZONE	LUMENS	%LAMP	%FIXT
0-30	398	7.1	9.5
0-40	592	10.6	14.1
0-60	880	15.7	21.0
0-90	970	17.3	23.2
90-120	911	16.3	21.8
90-130	1501	26.8	35.8
90-150	2569	45.9	61.3
90-180	3220	57.5	76.8
0-180	4190	74.8	100.0

TOTAL LUMINAIRE EFFICIENCY = 74.8%

#### CANDELA DISTRIBUTION

	0.0	22.5	45.0	67.5	90.0	FLUX
0	623	623	623	623	623	
5	617	618	611	606	603	58
15	562	555	526	508	498	149
25	488	461	402	378	370	192
35	399	347	280	276	277	194
45	297	232	187	195	207	166
55	185	129	116	131	145	121
65	70	52	58	79	77	64
75	26	21	17	18	19	21
85	5	6	5	5	5	6
90	0	1	2	2	2	
95	21	62	56	66	59	69
105	116	287	346	302	270	304
115	234	432	580	712	712	539
125	361	544	714	783	822	590
135	480	597	786	894	932	575
145	585	657	813	911	942	492
155	669	713	769	849	891	361
165	727	744	771	791	800	218
175	757	759	757	756	759	73
180	757	757	757	757	757	

KSD3053.0301

### Photometric Reports

SERIES 10: PLV - CCO - 3 T8 - EP (ITL REPORT 50836)

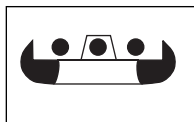

55% Uplight  
45% Downlight



LEGEND:  
0-deg. - - - - -  
45-deg. - - - - -  
90-deg. ————

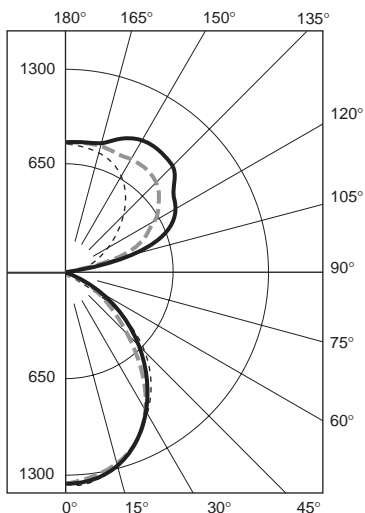

TOTAL LUMINAIRE EFFICIENCY = 68.1%

CANDELA DISTRIBUTION					FLUX	
	0.0	22.5	45.0	67.5	90.0	
0	1351	1351	1351	1351	1351	
5	1340	1341	1338	1331	1326	126
15	1226	1231	1217	1218	1219	345
25	1074	1067	1042	1061	1077	488
35	888	865	839	875	910	543
45	669	645	622	616	628	487
55	425	403	350	332	343	330
65	161	165	131	136	137	148
75	60	51	37	48	57	52
85	7	9	8	12	13	12
90	0	3	3	3	3	
95	24	64	62	69	62	70
105	122	287	350	303	279	306
115	242	424	568	693	707	529
125	370	534	696	760	798	577
135	491	594	766	868	903	565
145	598	659	801	888	917	487
155	686	717	771	844	882	361
165	744	756	775	794	803	219
175	774	775	773	771	774	74
180	771	771	771	771	771	

#### ZONAL LUMEN SUMMARY

ZONE	LUMENS	%LAMP	%FIXT
0-30	959	11.4	16.8
0-40	1502	17.9	26.3
0-60	2319	27.6	40.6
0-90	2531	30.1	44.3
90-120	904	10.8	15.8
90-130	1481	17.6	25.9
90-150	2533	30.2	44.3
90-180	3187	37.9	55.7
0-180	5718	68.1	100.0

For layouts or additional photometry, contact your local representative or the factory.

### Photometric Reports

#### SERIES 10: PLV - CCO - 1 T8 - 91W (ITL REPORT 50814)

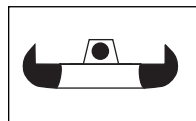

5% Uplight  
95% Downlight



LEGEND:  
0-deg. - - - - -  
45-deg. - - - - -  
90-deg. ————

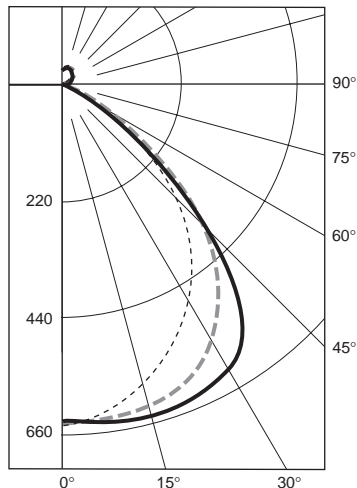

#### ZONAL LUMEN SUMMARY

ZONE	LUMENS	%LAMP	%FIXT
0-30	504	18.0	33.7
0-40	822	29.4	54.9
0-60	1304	46.6	87.1
0-90	1418	50.6	94.7
90-120	20	0.7	1.3
90-130	34	1.2	2.3
90-150	61	2.2	4.1
90-180	79	2.8	5.3
0-180	1497	53.5	100.0

TOTAL LUMINAIRE EFFICIENCY = 53.5%

	CANDELA DISTRIBUTION					FLUX
	0.0	22.5	45.0	67.5	90.0	
0	645	645	645	645	645	
5	644	641	642	640	640	61
15	592	599	621	640	651	175
25	520	542	581	620	641	267
35	432	466	510	553	584	318
45	330	372	400	386	390	292
55	212	250	215	183	184	190
65	83	102	66	54	58	76
75	32	31	21	30	37	31
85	6	6	6	8	9	7
90	0	0	0	0	0	
95	2	1	1	1	1	1
105	6	12	4	3	2	7
115	9	14	14	11	10	12
125	13	17	16	16	13	14
135	15	19	19	19	18	14
145	17	20	22	21	22	13
155	18	21	24	25	26	11
165	19	20	23	24	25	6
175	19	19	20	20	20	2
180	20	20	20	20	20	

#### SERIES 10: PLV - CCO - 2 T8 - 91W (ITL REPORT 50815)

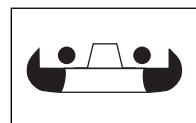

75% Uplight  
25% Downlight



LEGEND:  
0-deg. - - - - -  
45-deg. - - - - -  
90-deg. ————

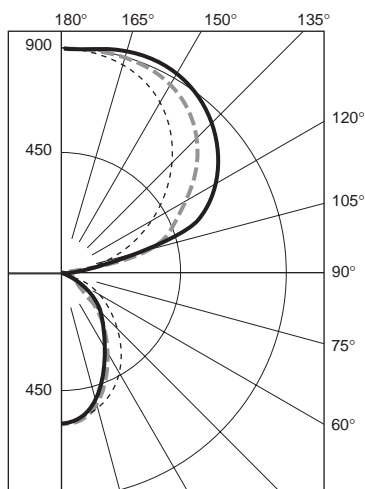

#### ZONAL LUMEN SUMMARY

ZONE	LUMENS	%LAMP	%FIXT
0-30	399	7.1	9.7
0-40	594	10.6	14.4
0-60	883	15.8	21.4
0-90	970	17.3	23.5
90-120	812	14.5	19.7
90-130	1345	24.0	32.6
90-150	2409	43.0	58.4
90-180	3152	56.3	76.5
0-180	4122	73.6	100.0

TOTAL LUMINAIRE EFFICIENCY = 73.6%

	CANDELA DISTRIBUTION					FLUX
	0.0	22.5	45.0	67.5	90.0	
0	619	619	619	619	619	
5	612	613	609	606	603	57
15	559	554	526	510	500	149
25	485	461	402	380	372	192
35	395	348	280	278	280	195
45	293	232	188	196	210	168
55	183	129	116	132	147	122
65	68	50	58	82	89	65
75	24	18	15	17	19	19
85	2	3	2	3	4	4
90	0	0	0	0	0	
95	23	68	62	63	58	69
105	142	253	309	313	303	288
115	287	403	474	544	563	455
125	439	550	610	661	676	533
135	581	665	735	777	786	553
145	705	759	834	875	881	511
155	803	829	880	917	931	404
165	872	878	894	912	923	253
175	906	906	900	897	899	86
180	905	905	905	905	905	

KSID:3046:0301

### Photometric Reports

SERIES 10: PLV - CCO - 3 T8 - 91W (ITL REPORT 50816)

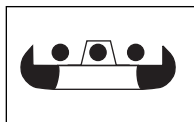

55% Uplight  
45% Downlight



LEGEND:  
0-deg. - - - - -  
45-deg. - - - - -  
90-deg. ————

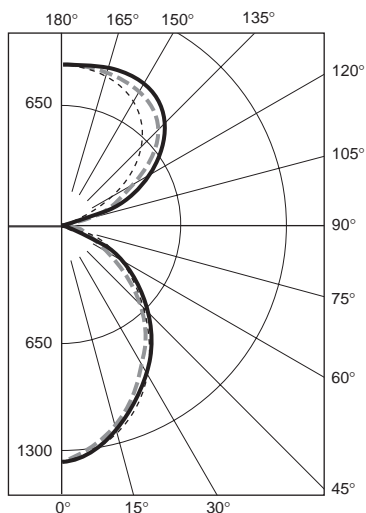

TOTAL LUMINAIRE EFFICIENCY = 67.7%

CANDELA DISTRIBUTION						FLUX	
	0.0	22.5	45.0	67.5	90.0		
0	1356	1356	1356	1356	1356		
5	1344	1346	1342	1335	1333	127	
15	1232	1236	1223	1223	1225	346	
25	1078	1071	1044	1066	1079	490	
35	891	866	841	881	919	545	
45	672	646	626	621	636	490	
55	425	406	355	336	349	334	
65	166	167	134	141	149	152	
75	61	53	39	50	61	55	
85	10	11	10	14	16	13	
90	0	2	3	2	2		
95	24	69	63	68	59	71	
105	147	252	309	313	303	289	
115	296	399	466	532	549	449	
125	451	550	599	644	658	525	
135	590	668	722	759	767	546	
145	712	762	829	857	861	507	
155	808	837	880	916	928	404	
165	875	887	899	914	922	255	
175	909	912	909	904	906	87	
180	907	907	907	907	907		

#### ZONAL LUMEN SUMMARY

ZONE	LUMENS	%LAMP	%FIXT
0-30	963	11.5	16.9
0-40	1508	18	26.5
0-60	2331	27.8	41
0-90	2551	30.4	44.9
90-120	809	9.6	14.2
90-130	1334	15.9	23.5
90-150	2387	28.4	42
90-180	3132	37.3	55.1
0-180	5684	67.7	100

For layouts or additional photometry, contact your local representative or the factory.

### Photometric Reports

#### SERIES 10: PLV - STO - 1 T8 - 91W (ITL REPORT 50817)

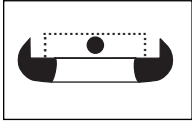

30% Uplight  
70% Downlight



LEGEND:  
0-deg. - - - - -  
45-deg. - - - - -  
90-deg. ————

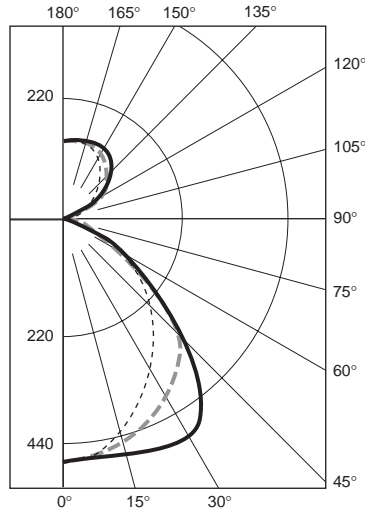

#### ZONAL LUMEN SUMMARY

ZONE	LUMENS	%LAMP	%FIXT
0-30	370	13.2	23.4
0-40	614	21.9	38.8
0-60	997	35.6	63.1
0-90	1112	39.7	70.4
90-120	103	3.7	6.5
90-130	178	6.4	11.3
90-150	346	12.4	21.9
90-180	468	16.7	29.6
0-180	1580	56.4	100.0

TOTAL LUMINAIRE EFFICIENCY = 56.4%

#### CANDELA DISTRIBUTION

	0.0	22.5	45.0	67.5	90.0	FLUX
0	463	463	463	463	463	
5	461	461	462	461	461	44
15	425	432	450	468	477	127
25	376	393	430	471	493	199
35	312	342	393	439	465	244
45	239	277	314	318	323	228
55	154	192	177	158	164	155
65	64	78	68	84	98	78
75	24	25	23	32	39	30
85	4	4	6	8	9	7
90	0	1	2	2	3	
95	2	7	11	21	19	14
105	17	27	30	47	56	37
115	41	53	51	56	55	52
125	66	79	86	95	91	75
135	91	102	114	124	123	86
145	113	121	132	141	143	82
155	131	135	143	150	152	66
165	144	146	148	152	153	42
175	151	152	151	150	150	14
180	151	151	151	151	151	

#### SERIES 10: PLV - STO - 2 T8 - 91W (ITL REPORT 50818)

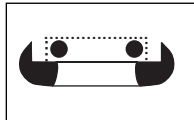

35% Uplight  
65% Downlight



LEGEND:  
0-deg. - - - - -  
45-deg. - - - - -  
90-deg. ————

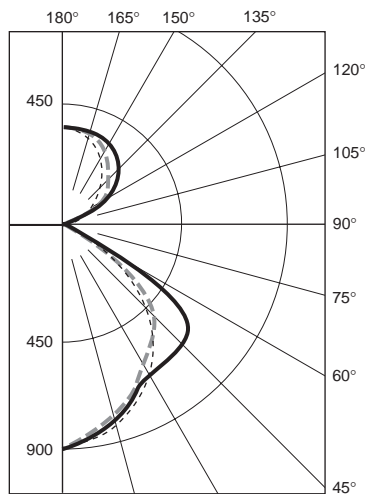

#### ZONAL LUMEN SUMMARY

ZONE	LUMENS	%LAMP	%FIXT
0-30	627	11.2	20.4
0-40	1000	17.9	32.6
0-60	1742	31.1	56.8
0-90	1985	35.4	64.7
90-120	243	4.3	7.9
90-130	420	7.5	13.7
90-150	799	14.3	26.0
90-180	1082	19.3	35.3
0-180	3067	54.8	100.0

TOTAL LUMINAIRE EFFICIENCY = 54.8%

#### CANDELA DISTRIBUTION

	0.0	22.5	45.0	67.5	90.0	FLUX
0	894	894	894	894	894	
5	887	886	883	880	874	83
15	817	814	795	790	786	225
25	723	703	676	680	690	318
35	602	574	554	619	668	373
45	457	434	477	584	659	396
55	300	289	378	476	538	346
65	125	145	184	197	206	176
75	49	49	43	54	67	55
85	8	8	9	13	15	12
90	0	1	2	5	4	
95	5	16	20	32	29	25
105	37	63	79	104	103	84
115	86	114	131	166	174	135
125	144	173	198	229	229	176
135	205	228	253	282	283	194
145	258	275	297	318	321	185
155	305	314	329	344	347	151
165	340	344	346	352	354	98
175	358	360	358	357	356	34
180	359	359	359	359	359	

### Photometric Reports

SERIES 10: PLV - STO - 3 T8 - 91W (ITL REPORT 50819)

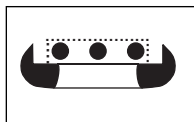

35% Uplight  
65% Downlight



LEGEND:  
0-deg. - - - - -  
45-deg. - - - - -  
90-deg. ————

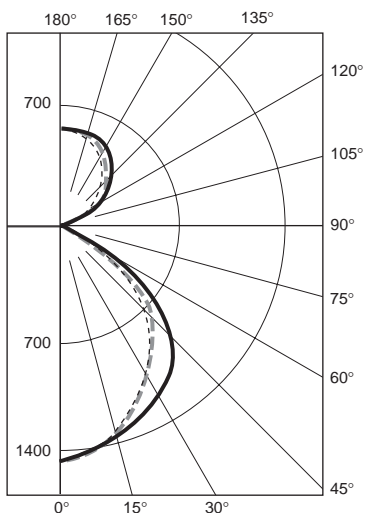

**ZONAL LUMEN SUMMARY**

ZONE	LUMENS	%LAMP	%FIXT
0-30	1073	12.8	22.8
0-40	1727	20.6	36.8
0-60	2830	33.7	60.2
0-90	3142	37.4	66.9
90-120	307	3.7	6.5
90-130	557	6.6	11.9
90-150	1123	13.4	23.9
90-180	1556	18.5	33.1
0-180	4698	55.9	100.0

TOTAL LUMINAIRE EFFICIENCY = 55.9%

CANDELA DISTRIBUTION					FLUX
	0.0	22.5	45.0	67.5	90.0
0	1462	1462	1462	1462	1462
5	1452	1453	1448	1441	1435 137
15	1333	1339	1338	1353	1361 379
25	1173	1175	1186	1243	1283 557
35	976	977	1017	1116	1184 654
45	745	757	814	862	920 628
55	478	503	510	570	635 474
65	186	209	216	222	238 222
75	71	69	56	72	88 74
85	9	11	11	17	19 15
90	0	2	4	6	7
95	6	19	23	38	33 29
105	54	80	95	123	120 102
115	124	157	169	207	212 176
125	216	252	281	321	318 250
135	309	342	374	414	415 287
145	394	418	448	478	482 279
155	468	481	500	520	524 230
165	521	527	529	539	542 150
175	551	553	549	547	546 52
180	551	551	551	551	551

For layouts or additional photometry, contact your local representative or the factory.

### Photometric Reports

#### SERIES 10: PLV - TDO - 1 T8 - 91W (ITL REPORT 50820)

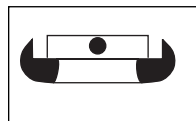

100% Downlight



LEGEND:  
 0-deg. - - - - -  
 45-deg. - - - - -  
 90-deg. ————

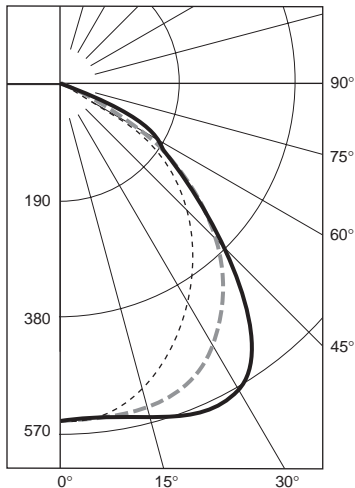

TOTAL LUMINAIRE EFFICIENCY = 46.9%

	CANDELA DISTRIBUTION					FLUX
	0.0	22.5	45.0	67.5	90.0	
0	545	545	545	545	545	
5	542	543	544	543	545	52
15	498	508	529	551	562	150
25	438	458	504	552	578	234
35	365	399	462	510	534	284
45	277	324	360	368	380	266
55	178	223	210	201	217	188
65	74	92	89	113	129	97
75	29	29	27	37	46	35
85	4	5	5	8	10	8
90	0	0	0	0	0	

#### ZONAL LUMEN SUMMARY

ZONE	LUMENS	%LAMP	%FIXT
0-30	436	15.6	33.2
0-40	719	25.7	54.8
0-60	1173	41.9	89.3
0-90	1313	46.9	100.0
90-180	0	0.0	0.0
0-180	1313	46.9	100.0

#### SERIES 10: PLV - TDO - 2 T8 - 91W (ITL REPORT 50821)

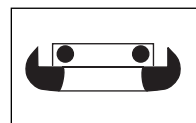

100% Downlight



LEGEND:  
 0-deg. - - - - -  
 45-deg. - - - - -  
 90-deg. ————

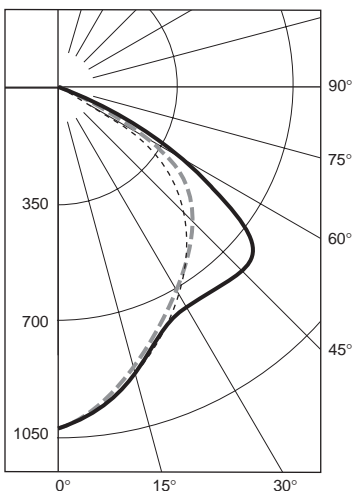

TOTAL LUMINAIRE EFFICIENCY = 41.5%

	CANDELA DISTRIBUTION					FLUX
	0.0	22.5	45.0	67.5	90.0	
0	1021	1021	1021	1021	1021	
5	1014	1014	1011	1007	1006	96
15	929	933	920	920	921	261
25	819	810	794	813	830	374
35	682	665	665	745	808	442
45	519	505	571	703	797	470
55	339	339	449	555	612	403
65	140	165	213	229	257	204
75	52	53	48	59	77	61
85	9	9	9	14	16	13
90	0	0	0	0	0	

#### ZONAL LUMEN SUMMARY

ZONE	LUMENS	%LAMP	%FIXT
0-30	730	13	31.4
0-40	1172	20.9	50.5
0-60	2044	36.5	88.0
0-90	2322	41.5	100.0
90-180	0	0.0	0.0
0-180	2322	41.5	100.0

### Photometric Reports

SERIES 10: PLV - TDO - 3 T8 - 91W (ITL REPORT 50822)

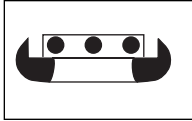

100% Downlight



LEGEND:  
 0-deg. - - - - -  
 45-deg. - - - - -  
 90-deg. ————

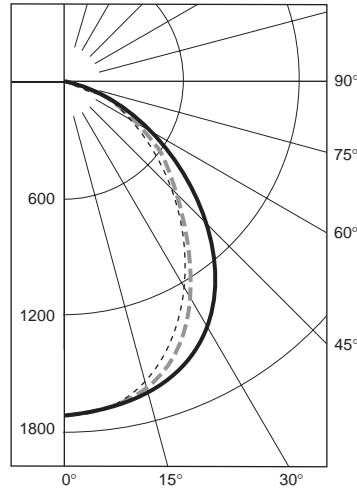

TOTAL LUMINAIRE EFFICIENCY = 43.2%

	CANDELA DISTRIBUTION					FLUX
	0.0	22.5	45.0	67.5	90.0	
0	1687	1687	1687	1687	1687	1687
5	1671	1673	1672	1668	1668	158
15	1534	1545	1556	1580	1596	441
25	1350	1361	1391	1460	1513	650
35	1123	1134	1198	1292	1361	759
45	851	882	933	974	1044	719
55	545	586	579	637	706	541
65	219	244	252	260	285	255
75	83	77	65	81	101	84
85	13	14	14	20	23	19
90	0	0	0	0	0	

#### ZONAL LUMEN SUMMARY

ZONE	LUMENS	%LAMP	%FIXT
0-30	1250	14.9	34.5
0-40	2010	23.9	55.4
0-60	3270	38.9	90.1
0-90	3629	43.2	100.0
90-180	0	0.0	0.0
0-180	3629	43.2	100.0

For layouts or additional photometry, contact your local representative or the factory.

### Photometric Reports

#### SERIES 10: CUB - OPEN - 1 T8 - 91W (ITL REPORT 50826)

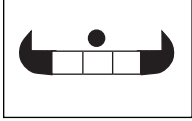

75% Uplight  
25% Downlight



LEGEND:  
0-deg. - - - - -  
45-deg. - - - - -  
90-deg. ————

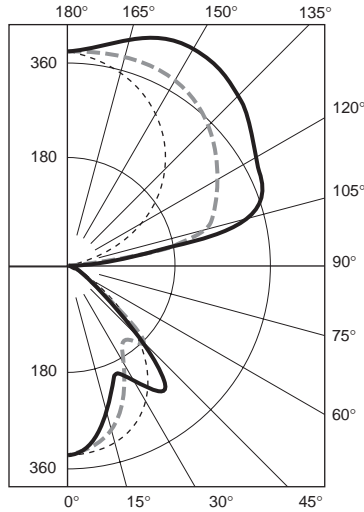

#### ZONAL LUMEN SUMMARY

ZONE	LUMENS	%LAMP	%FIXT
0-30	221	7.9	10.1
0-40	354	12.6	16.1
0-60	511	18.2	23.2
0-90	515	18.4	23.4
90-120	591	21.1	26.9
90-130	870	31.1	39.6
90-150	1364	48.7	62.1
90-180	1682	60.1	76.6
0-180	2197	78.5	100.0

TOTAL LUMINAIRE EFFICIENCY = 78.5%

#### CANDELA DISTRIBUTION

	0.0	22.5	45.0	67.5	90.0	FLUX
0	344	344	344	344	344	
5	345	345	341	338	333	32
15	322	321	296	282	262	83
25	284	269	209	202	192	106
35	231	194	174	222	278	132
45	163	135	185	199	178	129
55	4	29	31	20	4	28
65	0	2	2	3	2	2
75	0	1	2	2	2	2
85	0	0	0	1	1	0
90	0	0	0	0	0	
95	9	86	79	105	79	84
105	53	149	244	326	345	238
115	112	196	287	354	375	268
125	175	244	322	388	407	279
135	234	288	351	402	423	265
145	286	324	373	412	427	230
155	327	350	382	409	421	175
165	356	366	381	391	399	107
175	371	373	375	373	375	36
180	371	371	371	371	371	

#### SERIES 10: CUB - OPEN - 2 T8 - 91W (ITL REPORT 50827)

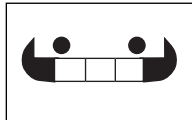

80% Uplight  
20% Downlight



LEGEND:  
0-deg. - - - - -  
45-deg. - - - - -  
90-deg. ————

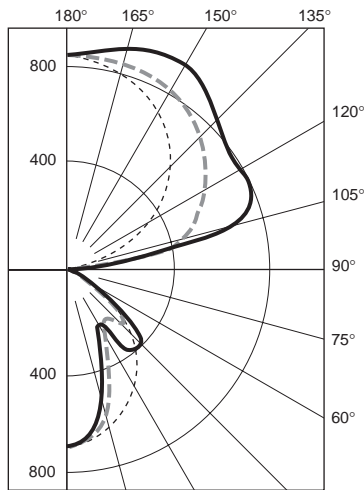

#### ZONAL LUMEN SUMMARY

ZONE	LUMENS	%LAMP	%FIXT
0-30	426	7.6	9.8
0-40	628	11.2	14.4
0-60	928	16.6	21.3
0-90	936	16.7	21.5
90-120	1110	19.8	25.5
90-130	1675	29.9	38.4
90-150	2720	48.6	62.4
90-180	3421	61.1	78.5
0-180	4358	77.8	100.0

TOTAL LUMINAIRE EFFICIENCY = 77.8%

#### CANDELA DISTRIBUTION

	0.0	22.5	45.0	67.5	90.0	FLUX
0	697	697	697	697	697	
5	698	697	689	682	675	65
15	655	642	603	566	531	167
25	582	539	401	313	278	194
35	481	375	235	257	303	202
45	349	215	273	376	397	235
55	12	46	76	45	11	65
65	3	5	5	5	5	5
75	1	3	3	3	4	3
85	0	0	1	1	1	1
90	0	0	0	0	0	
95	23	125	132	141	127	132
105	131	283	475	541	539	428
115	267	403	562	732	781	550
125	407	518	647	750	789	566
135	537	629	731	815	844	553
145	649	717	795	860	881	492
155	738	780	838	879	893	383
165	799	817	846	869	880	239
175	830	832	834	832	836	80
180	829	829	829	829	829	

KSID:3050.0301

### Photometric Reports

SERIES 10: CUB - OPEN - 3 T8 - 91W (ITL REPORT 50828)

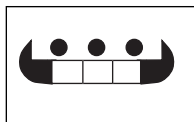

75% Uplight  
25% Downlight



LEGEND:  
0-deg. - - - - -  
45-deg. - - - - -  
90-deg. ————

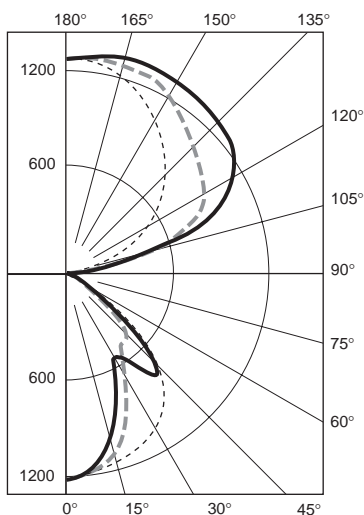

#### ZONAL LUMEN SUMMARY

ZONE	LUMENS	%LAMP	%FIXT
0-30	763	9.1	11.7
0-40	1165	13.9	17.9
0-60	1666	19.8	25.6
0-90	1678	20.0	25.8
90-120	1397	16.6	21.4
90-130	2245	26.7	34.5
90-150	3788	45.1	58.1
90-180	4837	57.6	74.2
0-180	6515	77.6	100.0

TOTAL LUMINAIRE EFFICIENCY = 77.6%

CANDELA DISTRIBUTION					FLUX	
	0.0	22.5	45.0	67.5	90.0	
0	1221	1221	1221	1221	1221	
5	1223	1216	1202	1187	1179	113
15	1151	1125	1042	970	919	292
25	1028	942	724	633	594	358
35	855	667	508	592	693	402
45	625	429	518	586	581	405
55	20	76	115	59	17	96
65	2	6	7	7	7	6
75	0	3	4	6	6	4
85	0	1	2	3	3	1
90	0	0	0	0	0	
95	37	131	129	144	128	140
105	206	437	540	563	545	500
115	412	589	838	959	968	758
125	618	762	970	1158	1203	847
135	814	940	1064	1201	1256	819
145	976	1089	1162	1242	1273	724
155	1111	1180	1259	1290	1303	570
165	1202	1233	1278	1310	1327	360
175	1247	1252	1253	1252	1257	120
180	1246	1246	1246	1246	1246	

For layouts or additional photometry, contact your local representative or the factory.

### Photometric Reports

#### SERIES 10: CUB - STO - 3 T8 - 91W (ITL REPORT 50829)

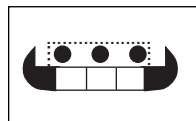

40% Uplight  
60% Downlight



LEGEND:  
0-deg. - - - - -  
45-deg. - - - - -  
90-deg. ————

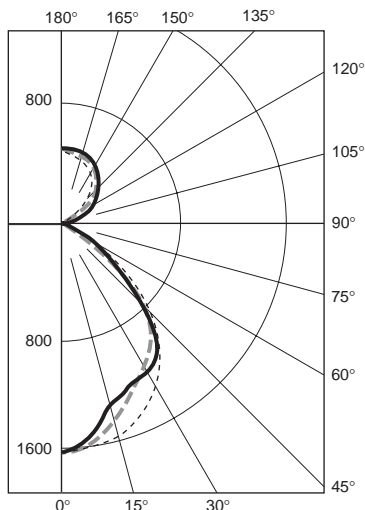

#### ZONAL LUMEN SUMMARY

ZONE	LUMENS	%LAMP	%FIXT
0-30	1160	13.8	27.4
0-40	1867	22.2	44.1
0-60	2614	31.1	61.7
0-90	2625	31.3	62.0
90-120	319	3.8	7.5
90-130	576	6.9	13.6
90-150	1161	13.8	27.4
90-180	1611	19.2	38.0
0-180	4236	50.4	100.0

TOTAL LUMINAIRE EFFICIENCY = 50.4%

	CANDELA DISTRIBUTION					FLUX
	0.0	22.5	45.0	67.5	90.0	
0	1627	1627	1627	1627	1627	
5	1630	1625	1610	1589	1581	152
15	1544	1523	1455	1408	1389	413
25	1392	1327	1247	1258	1259	595
35	1174	1099	1094	1157	1195	706
45	885	856	807	753	731	614
55	22	123	134	69	17	134
65	3	5	6	7	7	6
75	0	2	4	5	6	3
85	0	0	2	3	4	2
90	0	0	2	2	2	
95	9	18	27	38	39	30
105	61	83	103	125	128	107
115	132	161	179	213	220	182
125	227	254	293	323	331	258
135	324	350	389	421	427	296
145	413	431	462	490	499	288
155	487	501	521	536	539	239
165	542	548	554	563	562	156
175	569	570	568	567	568	54
180	568	568	568	568	568	

#### SERIES 10: CUB - TDO - 3 T8 - 91W (ITL REPORT 50830)

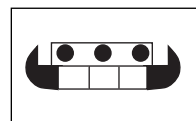

100% Downlight



LEGEND:  
0-deg. - - - - -  
45-deg. - - - - -  
90-deg. ————

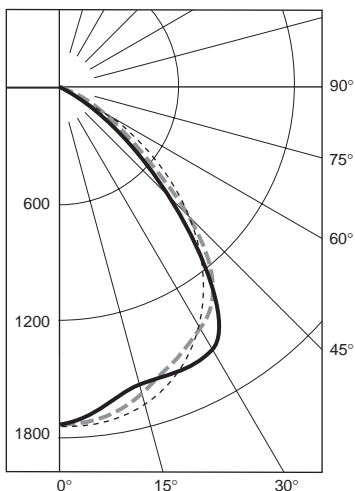

#### ZONAL LUMEN SUMMARY

ZONE	LUMENS	%LAMP	%FIXT
0-30	1304	15.5	43.5
0-40	2132	25.4	71.1
0-60	2984	35.5	99.5
0-90	2999	35.7	100.0
90-180	0	0.0	0.0
0-180	2999	35.7	100.0

TOTAL LUMINAIRE EFFICIENCY = 35.7%

	CANDELA DISTRIBUTION					FLUX
	0.0	22.5	45.0	67.5	90.0	
0	1747	1747	1747	1747	1747	
5	1750	1747	1733	1714	1709	164
15	1658	1640	1592	1563	1560	453
25	1498	1445	1459	1525	1552	687
35	1266	1245	1345	1399	1410	828
45	954	1016	935	835	802	698
55	24	143	155	81	20	154
65	5	6	7	8	8	7
75	1	3	5	7	7	5
85	0	1	2	4	5	2
90	0	0	0	0	0	