

FINELITE

Series 7V Joining Instructions (Semi-Adjustable Cable)*

DO NOT attempt to join fixtures together on the floor. Damage may result when lifted. Follow these instructions.

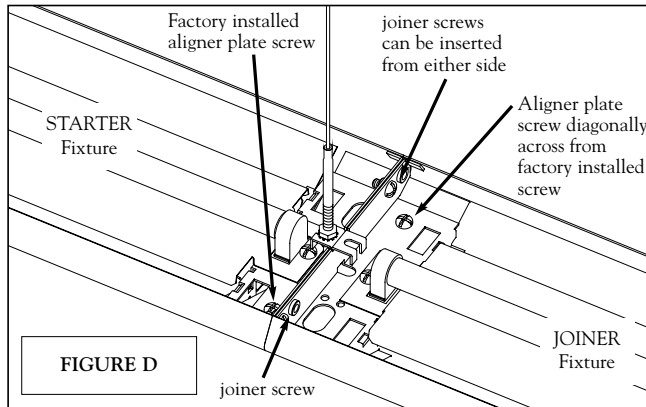
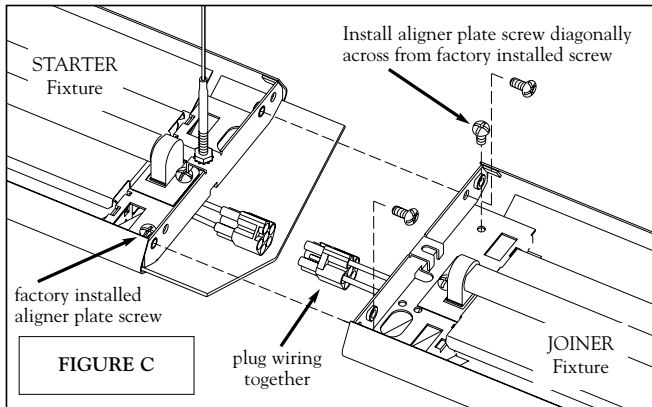
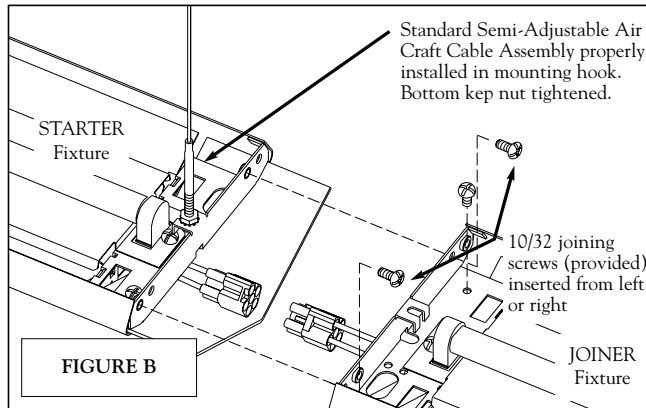
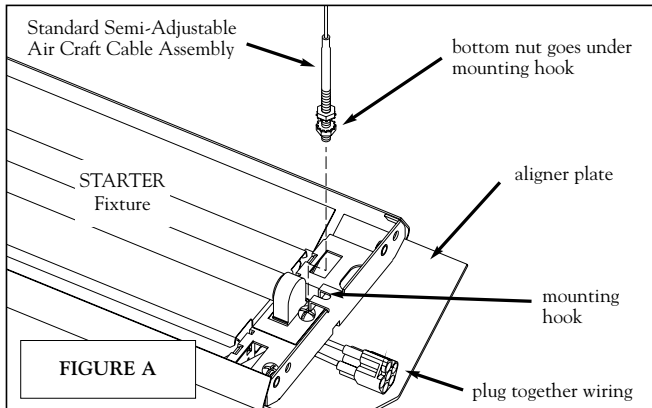

INSTRUCTIONS

STEP 1. Hang STARTER Fixture by placing bottom kep nut of Air Craft Cable assembly under mounting hook at endcap end, rotate up to sit securely on mounting hook, tighten securely (avoid over-tightening). Repeat with Air Craft Cable assembly at joining end. **FIGURE A.**

STEP 2. Hang far end of JOINER Fixture while supporting both ends. Connect plug together wiring between STARTER Fixture and JOINER Fixture. Slide JOINER Fixture onto aligner plate. Push fixtures together. Secure fixtures together with two 10/32 screws (provided). (Screws may be inserted from left or right). **FIGURE B.**

STEP 3. Identify the factory installed aligner plate screw inside fixture body. **Diagonally across** from the factory installed aligner plate screw, install 10/32 aligner plate screw (provided) into JOINER fixture. Secure tightly. **FIGURE C.**

FINAL CHECK—FIGURE D.

- Air Craft Cable assembly sits securely on mounting hook, bottom kep nut is tight.
- Plug together wiring is connected.
- **Two** 10/32 joiner screws have been installed between fixtures.
- **One** aligner plate screw has been installed **DIAGONALLY ACROSS** from factory installed aligner plate screw.

Repeat for remaining JOINER and ENDER fixtures to complete row.

* Pictured with Standard Semi-Adjustable Air Craft Cable Assembly. See additional instructions for Fully Adjustable Air Craft Cable hardware.

Finelite, Inc. ◊ 30500 Whipple Road ◊ Union City, CA 94587-1530 ◊ 510 / 441-1100 ◊ FAX: 510 / 441-1510 ◊ www.finelite.com