

High Performance Recessed (HPR-LED) 2x2 Surface Mount Installation

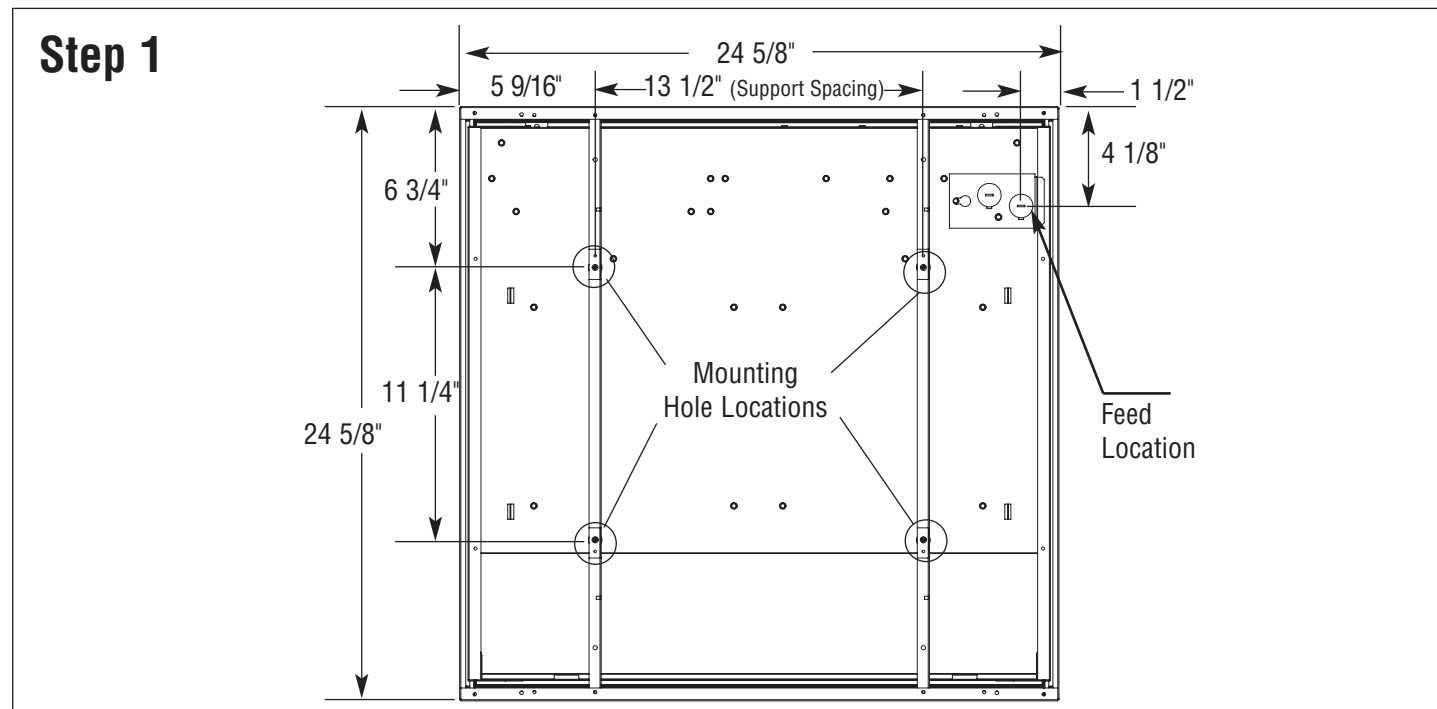

Use above measurements to define support spacing, mounting hole locations, and feed location.

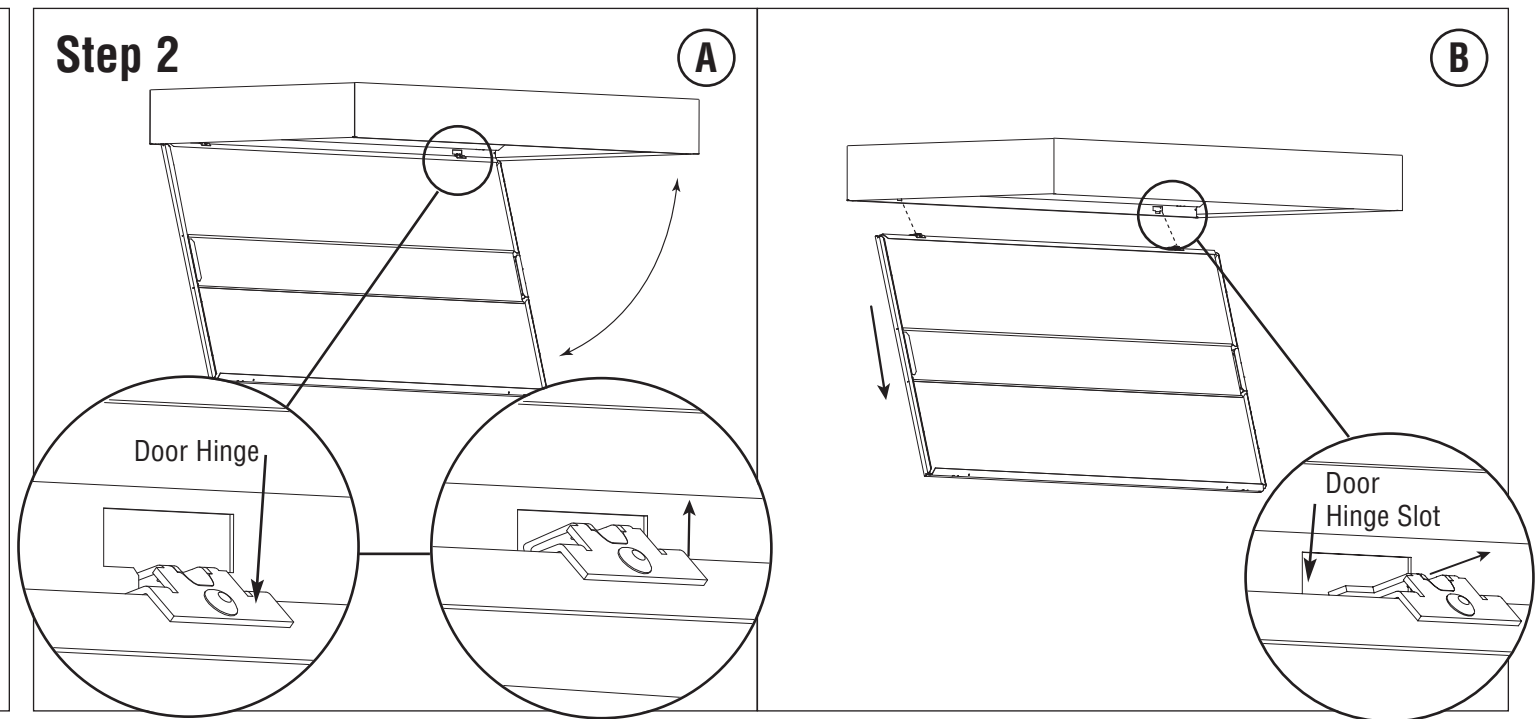

A. Lift door slightly to unhook door hinge.
B. Move the door towards center of the fixture to clear door hinge from hinge slot. Remove door from fixture.

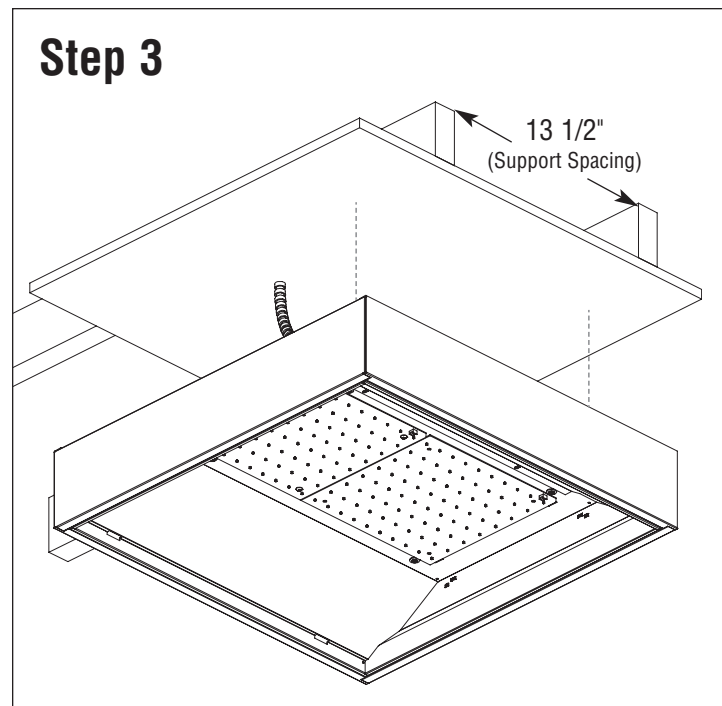

Provide proper backing support

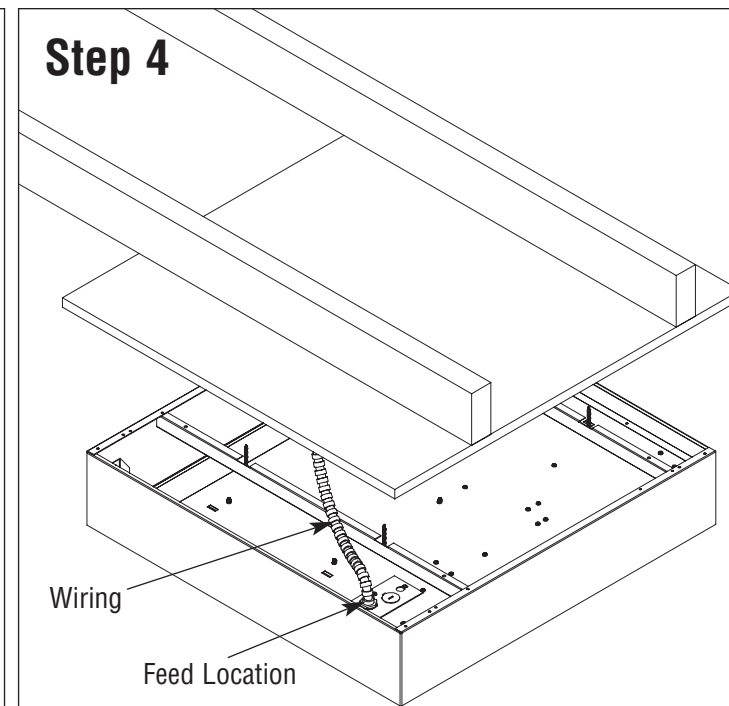

Connect fixture to power using approved methods. Refer to step 1 for feed location on the fixture.

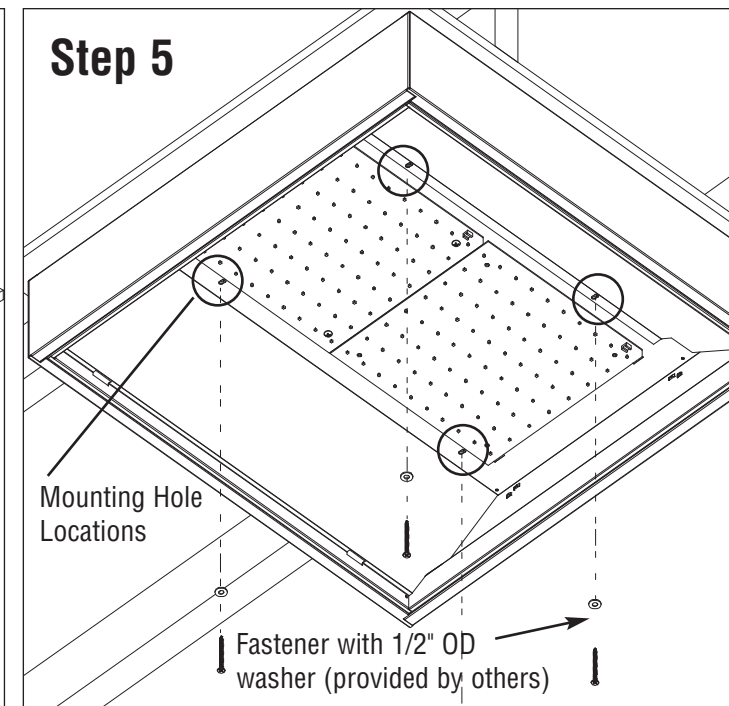

Install fixture using appropriate fastener with 1/2" OD washer (provided by others) at mounting hole locations.

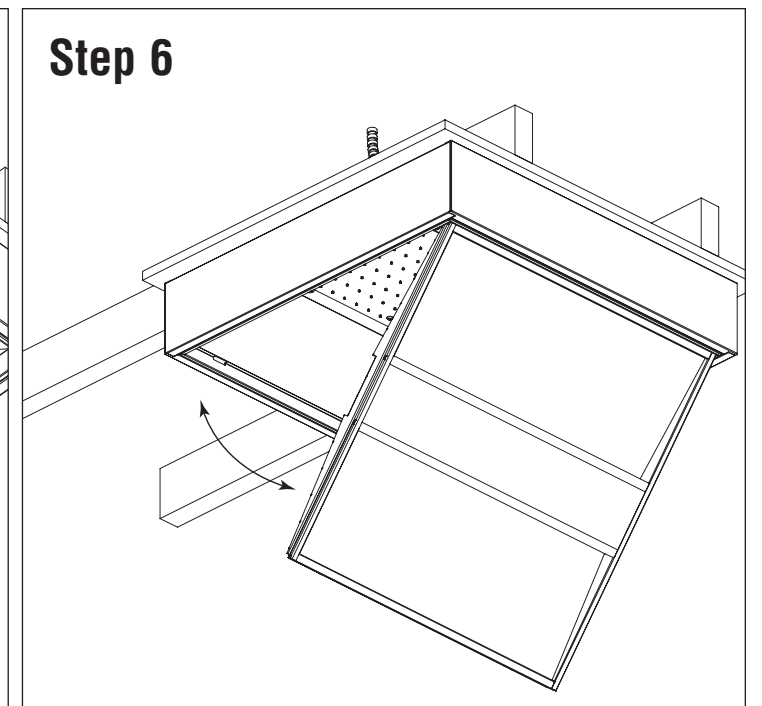

Reinstall door and turn power on.