

FINELITE
Better Lighting

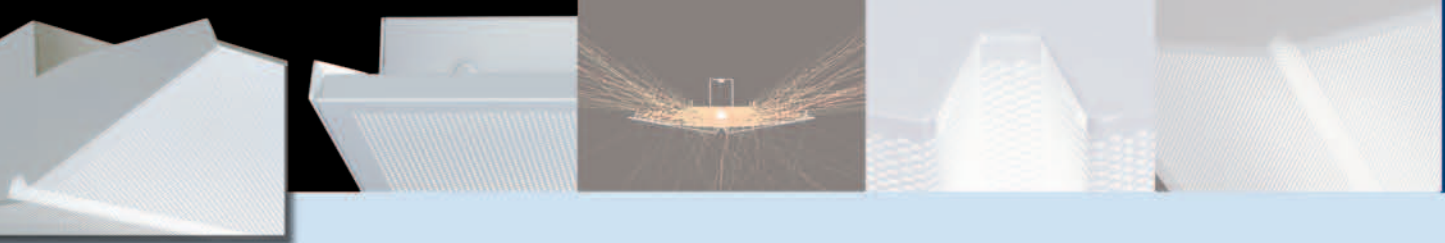

SERIES 15



Series 15* represents a new step in luminaire design by giving today's lighting professional the ability to evenly illuminate low ceiling environments with a comfortable and affordable indirect solution. This innovative fixture uses a double diffusing optical design and highly reflective components to distribute light at optimal angles and is very effective even when suspended just 3" from the ceiling. Series 15 merges the beauty of form with the strength of performance to deliver better lighting for a better workplace.

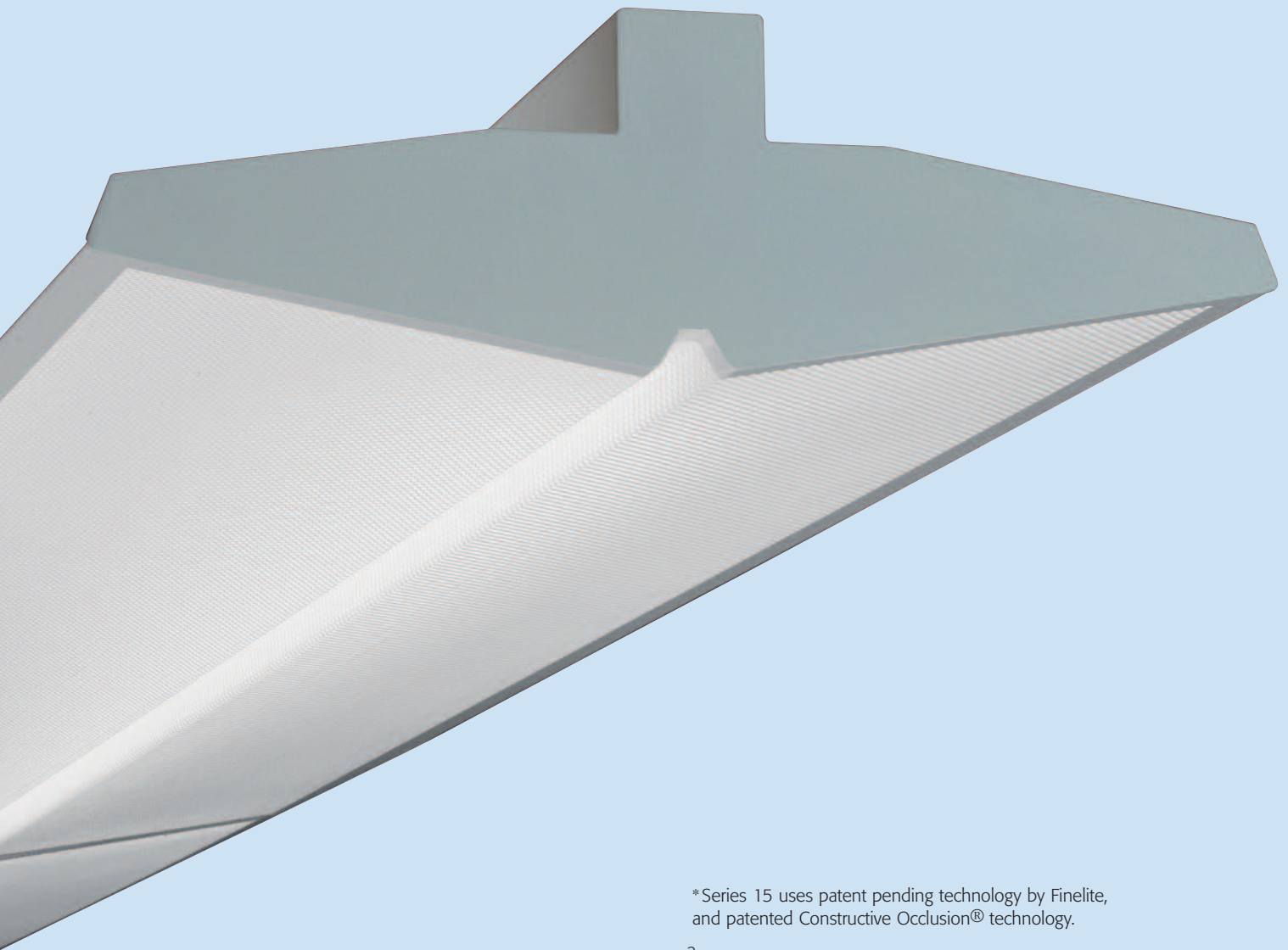

*Series 15 uses patent pending technology by Finelite, and patented Constructive Occlusion® technology.

Low Ceiling Solution



© 2005 JDN Photography

LOW CEILING OPEN OFFICE

This open office has 8'3" ceilings and is illuminated with Series 15 using a 2T8 lamp cross-section. Luminaires in this shadow free space are suspended 6" from the ceiling.

Distinctive Elements



SUPERIOR VISUAL CUTOFF

Side reflectors prevent direct view to the lamp at 90° for added comfort.



EASY ACCESS

Unique latch mechanism makes changing lamps quick and easy.



LONG, STRAIGHT ROWS

Factory installed die-formed aligner sleeves double the metal thickness at the joint adding significant strength and stability.

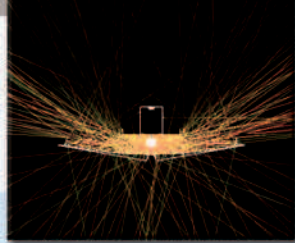

Series 15 Optics Make the Difference

SERIES 15 - 1 T5HO

Distribution: 75% up / 25% down
 Efficiency: 81.9%
 Peak Candella Value: 800@100°

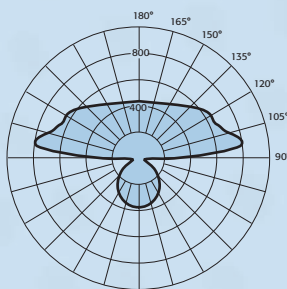

ZONE	LUMENS	%LAMP	%LUMINAIRE
0-30	280	6.24	7.61
0-40	449	9.99	12.19
0-60	741	16.48	20.12
0-90	919	20.44	24.96
40-90	470	10.46	12.77
60-90	178	3.96	4.84
90-180	2766	61.47	75.04
0-180	3686	81.92	100.00

CANDLEPOWER SUMMARY						
	0.0	22.5	45	67.5	90	Lumens
0	371	371	371	371	371	
5	369	370	370	370	370	36
15	348	349	353	355	354	99
25	310	313	317	324	324	146
35	259	265	272	279	279	169
45	197	202	214	218	222	162
55	129	136	149	156	157	130
65	69	75	87	93	95	84
75	29	34	42	47	49	44
85	3	11	33	47	76	50
90	0	0	0	0	0	
95	24	209	493	651	668	401
105	100	338	480	653	733	498
115	182	333	531	604	641	468
125	257	329	486	600	629	416
135	320	356	447	530	560	344
145	369	389	435	480	502	273
155	405	412	435	454	464	201
165	428	429	437	442	444	124
175	442	438	439	437	436	42
180	439	439	439	439	439	

SERIES 15 - 1 T8

Distribution: 80% up / 20% down
 Efficiency: 73.4%
 Peak Candella Value: 518@110°

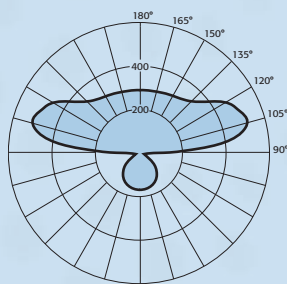

ZONE	LUMENS	%LAMP	%LUMINAIRE
0-30	129	4.33	5.90
0-40	210	7.02	9.56
0-60	353	11.80	16.07
0-90	432	14.41	19.63
40-90	221	7.39	10.07
60-90	78	2.61	3.56
90-180	1769	58.99	80.37
0-180	2201	73.39	100.00

CANDLEPOWER SUMMARY						
	0.0	22.5	45	67.5	90	Lumens
0	168	168	168	168	168	
5	166	167	167	167	167	16
15	159	160	161	161	163	45
25	144	146	149	152	153	68
35	122	126	131	134	134	81
45	95	98	105	108	108	79
55	63	67	74	76	79	64
65	31	34	40	44	45	39
75	10	14	18	22	23	19
85	1	4	13	22	26	20
90	0	0	0	0	0	
95	19	131	225	274	298	202
105	67	212	367	476	514	347
115	121	194	351	459	493	324
125	170	207	289	386	419	264
135	212	232	276	320	340	214
145	244	257	282	303	312	176
155	270	274	287	298	304	132
165	286	287	292	294	296	82
175	294	293	294	292	293	28
180	293	293	293	293	293	

SERIES 15 - 2 T8

Distribution: 78% up / 22% down
 Efficiency: 71.2%
 Peak Candella Value: 852@120°

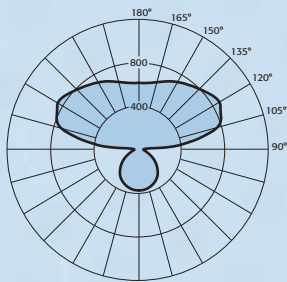

ZONE	LUMENS	%LAMP	%LUMINAIRE
0-30	293	4.89	6.86
0-40	474	7.90	11.10
0-60	794	13.25	18.60
0-90	961	16.02	22.49
40-90	487	8.12	11.39
60-90	166	2.77	3.89
90-180	3312	55.22	77.51
0-180	4274	71.24	100.00

CANDLEPOWER SUMMARY						
	0.0	22.5	45	67.5	90	Lumens
0	382	382	382	382	382	
5	378	379	379	380	381	37
15	361	363	366	367	369	103
25	326	330	335	340	342	154
35	277	284	292	299	299	181
45	213	220	233	240	244	177
55	139	149	164	173	177	144
65	68	76	95	101	106	89
75	21	30	41	46	50	42
85	2	9	24	44	52	36
90	0	0	0	0	0	
95	28	186	291	357	387	276
105	123	365	570	705	749	532
115	232	395	647	788	826	583
125	336	442	628	786	838	547
135	423	495	623	733	776	474
145	495	538	628	693	722	387
155	548	567	619	661	681	285
165	584	589	609	625	633	172
175	603	602	604	601	603	58
180	603	603	603	603	603	

Optimal Optics for Low Ceilings and Walls

OPEN OFFICE APPLICATION

Product: S15-1T5HO
 Room Dimensions: 40' x ≥40'
 Ceiling Height: 8'0"
 Ballast Factor: 1.0
 Light Loss Factor: 0.85
 IES File: LSI #18033

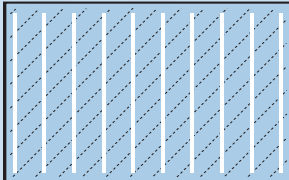

Suspension	3"		
Row Spacing	10'	12'	16'
# of 36' Rows	10	8	6
Avg FC Maintained	70.1 fc	60.2 fc	43.9 fc
Ceiling Uniformity	5:1	6:1	8:1
Power Density (w/Ft ²)	1.4	1.11	0.84

For an explanation on how ceiling uniformity is calculated consult the Series 15 AppGuide.

OPEN OFFICE APPLICATION

Product: S15-1T8
 Room Dimensions: 40' x ≥40'
 Ceiling Height: 8'0"
 Ballast Factor: 1.0
 Light Loss Factor: 0.85
 IES file: LSI #18056

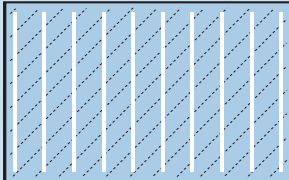

Suspension	3"		
Row Spacing	10'	12'	16'
# of 36' Rows	10	8	6
Avg FC Maintained	34.6 fc	30.1 fc	21.7 fc
Ceiling Uniformity	6:1	7:1	10:1
Power Density (w/Ft ²)	0.81	0.65	0.49

For an explanation on how ceiling uniformity is calculated consult the Series 15 AppGuide.

OPEN OFFICE APPLICATION

Product: S15-2T8
 Room Dimensions: 40' x ≥40'
 Ceiling Height: 8'0"
 Ballast Factor: 1.0
 Light Loss Factor: 0.85
 IES Files: LSI #18057

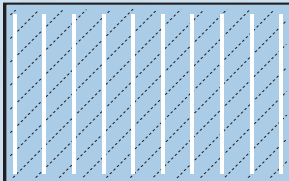

Suspension	3"		
Row Spacing	10'	12'	16'
# of 36' Rows	10	8	6
Avg FC Maintained	71.2 fc	61.9 fc	44.6 fc
Ceiling Uniformity	5:1	6:1	8:1
Power Density (w/Ft ²)	1.37	1.09	0.82

For an explanation on how ceiling uniformity is calculated consult the Series 15 AppGuide.



© 2006 Mert Carpenter Photography

Wall Mount Series 15

Mount Series 15 vertically for an attractive and energy efficient way to illuminate small spaces.

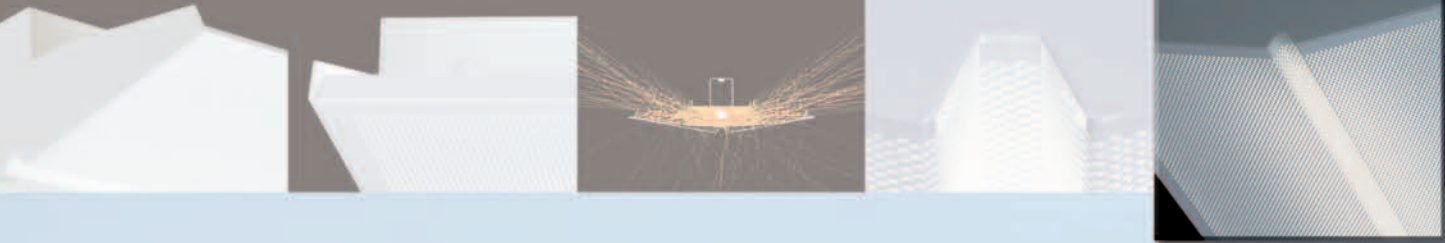

Mounting Challenges Conquered

With the unique ability to mount at the surface, on a 3" stem, or with aircraft cables from 3" to 150" long, Series 15 solves the problem of using indirect lighting in low ceiling areas.

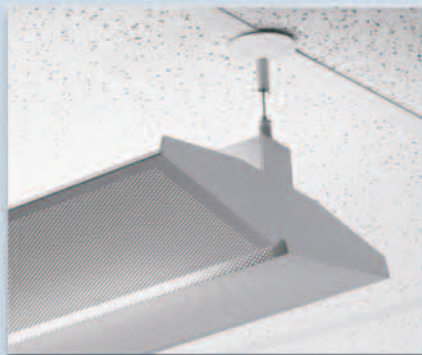

Standard (FA) Aircraft Cable suspends the fixture 3" from the ceiling.

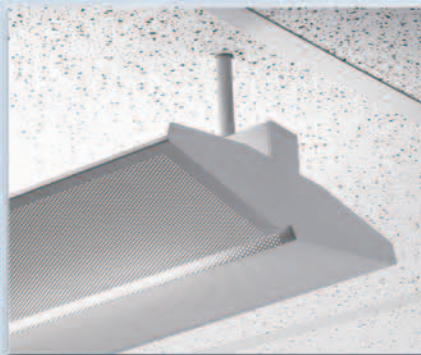

Optional Standoff Mount (SO) suspends the fixture on a 3" metal stem.

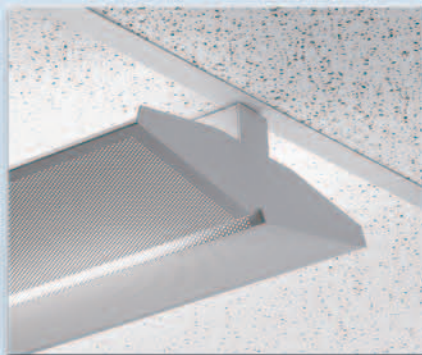

Optional Surface Mount (SM) attaches directly to ceiling or wall.

Inside The Design

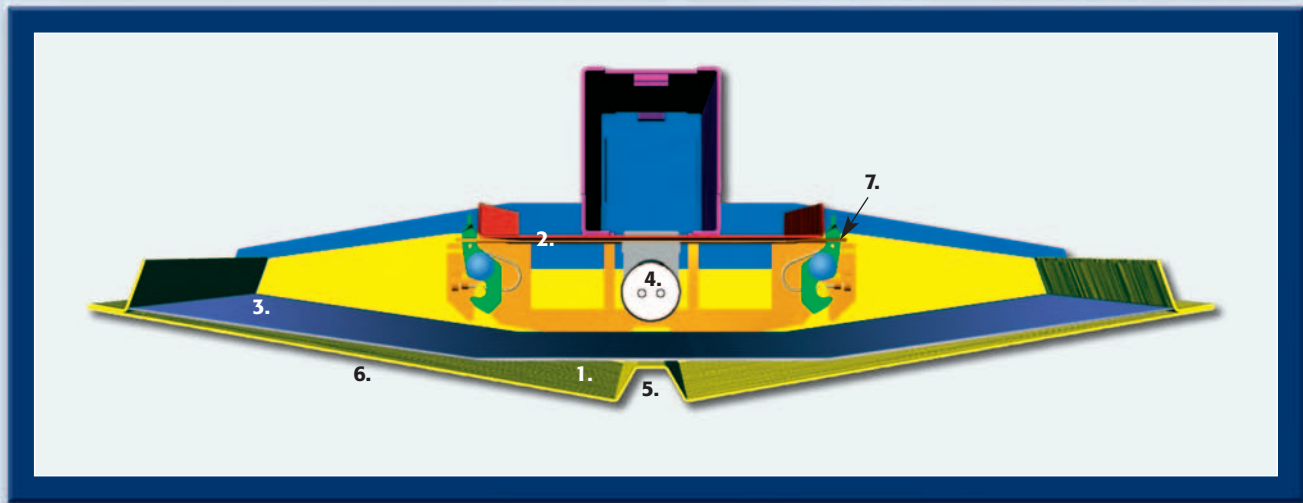

DOUBLE DIFFUSER OPTICAL DESIGN – 1.

Unique double diffusing optical design (patent pending) yields outstanding light distribution for low ceiling applications. Luminaire performance is designed around the 3" suspension, which is ideal for ceilings as low as 8'0".

96% REFLECTIVE – 2.

Upper reflector is finished in 96% reflective white painted material for optimal efficiency.

MICRO PRISM DIFFUSER – 3.

The micro prism diffuser is specially selected for its dual optical properties. Its specular side directs light out of the luminaire at optimal angles for low ceilings and light passing through the micro prism is refracted at low angles.

COMFORTABLE BRIGHTNESS – 4.

The patent pending optical design controls the brightness from the T5HO and T8 source to yield a very comfortable level of brightness throughout the visual range.

CENTER OPTICAL CHANNEL – 5.

The center optical channel provides a unique glowing edge that centers the eye and breaks up the even field of perforations.

DURABLE FINISH – 6.

Powder coat paint finish resists chipping and cleans easily for long-lasting beauty.

INTELLIGENT MECHANICAL DESIGN – 7.

The mechanical design reduces the number of unique parts required without sacrificing functionality making the technology more affordable.

Product Specifications

Series 15 continues Finelite's tradition that provides better lighting at affordable prices. Designed with precision engineering, S15 is built to hard tooled tolerances of 0.005". All fixtures come custom wired, fully assembled and ship from the factory within 10 working days.

DIMENSIONS

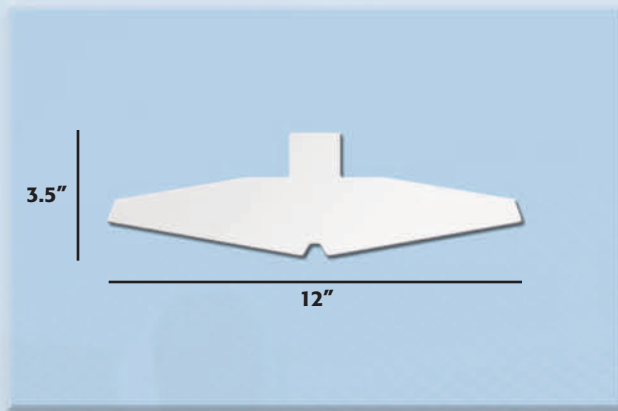

Series 15 measures 12" across and 3.5" high.

ENDCAPS

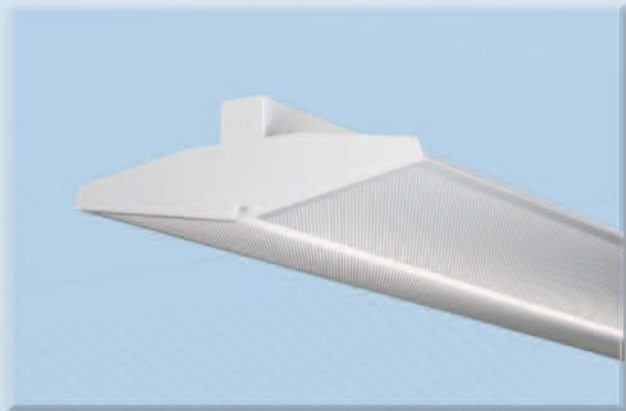

Standard flat endcap adds 0.1" at each end.

LENGTHS

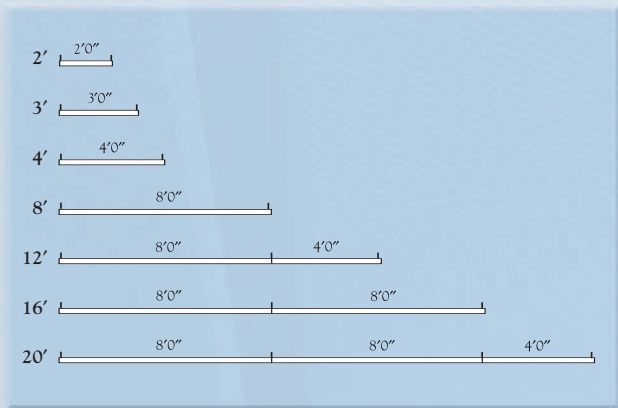

Modular section lengths of 4' and 8' can be combined to make runs as long as required. Contact factory for 2' and 3' lengths.

LAMPING

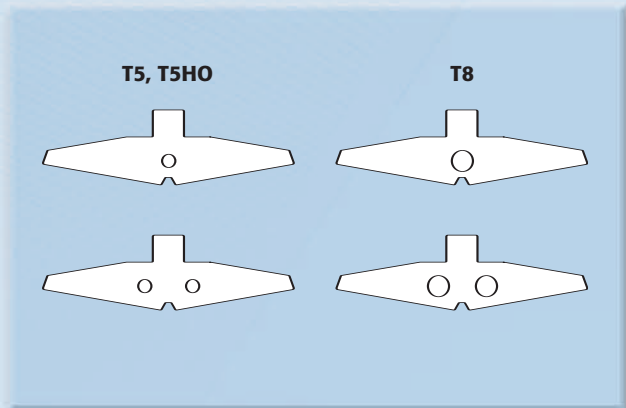

Series 15 is available in 1 or 2 T8, T5, or T5HO lamp cross sections.

ORDERING INFORMATION

(2) - S15 - 32 - 1T5HO - SC - 277 - FA

Quantity _____

Finelite Series 15 _____

Run length (2, 3, 4, 8 multiples standard) _____

Number of lamps in cross section (1, 2 T8, T5, or T5HO) _____

Circuiting (SC-single circuit, DC-dual circuit) _____

Voltage (120, 277 Volt) _____

Mounting (FA/SO/SM) _____



© 2005 JDN Photography

FINELITE

Better Lighting

Finelite, Inc.
30500 Whipple Road
Union City, CA 94587-1530
Phone 510/441-1100
Fax 510/441-1510
www.finelite.com

Form No CPI0020
© 2006 Finelite, Inc. All rights reserved.

