

Submitted by:		Date:
Type:	Project:	
Ordering Info:		

High Performance 2" Aperture (HP-2) Continuous Micro Louver



Micro Louver Continuous Black shown

The High Performance 2" Aperture Indirect/Direct, Direct, Surface Mount, and Recessed now available with Micro Louver options. The luminaire delivers excellent performance and uniform light distribution using an advanced optical design and mid-power LEDs, achieving 90% of initial light output at 100,000+ hours. Micro Louvers provide omnidirectional glare control and enhance the downlight aesthetic.

CROSS SECTIONS

Indirect/Direct

Top Glow (standard)

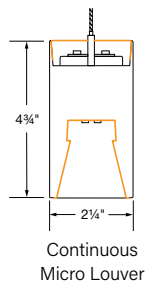

Direct

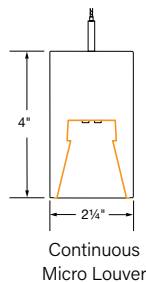

Surface Mount

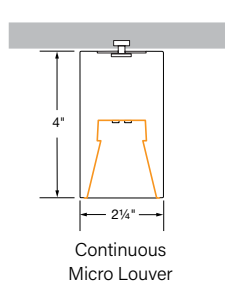

Recessed

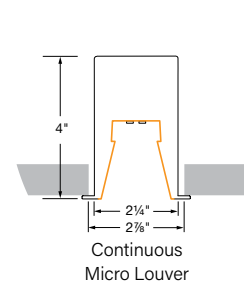

WHITE AND BLACK LOUVERS



Micro Louvers available in black or white, each with unique glare control and performance attributes. Combine with existing housing finishes for unique combinations.

OMNI-DIRECTIONAL GLARE CONTROL

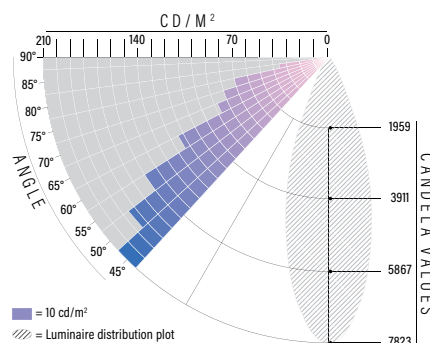

Minimized luminance values above 45° reduce eyestrain while supporting task performance and comfort. See page 6 for details.

ALSO AVAILABLE IN SEGMENTED SECTIONS

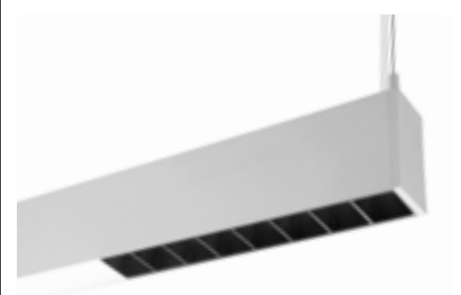

Micro Louver can be segmented with blank or illuminated sections. See Segmented Micro Louver technical sheet for details.



Submitted by:		Date:
Type:	Project:	
Ordering Info:		

High Performance 2" Aperture (HP-2) Continuous Micro Louver

Ordering Guide Example: HP - 2 - P - ID - 36' - S - 835 - F - MLW-CS - 120 - DC - FC-10% - FA50 - C1 - FE - SW - LGD18W - CP - 8ML - S - ABL - 8H - PEW

BODY TYPE

OUTPUT and LED TYPE

Platform	Series Name	Luminaire Type	Luminaire Distribution	Total Length of Run	Uplight Output (ID Only)	LED CRI/CCT
HP - High Performance	2	P - Pendant SM - Surface Mount R - Recessed	D - Direct ID - Indirect/Direct ¹	<hr/> Minimum 2' section length. 1ft increments. If specifying acoustics, multiples of 4' and 8' standard.	S - Standard (393 lm/ft) B - Boosted (494 lm/ft) H - High (747 lm/ft) V - Very High (961 lm/ft) TL - Tailored: _____lm/ft*	830 - 80 CRI, 3000K 835 - 80 CRI, 3500K 840 - 80 CRI, 4000K 930 - 90 CRI, 3000K 935 - 90 CRI, 3500K 940 - 90 CRI, 4000K 8TW - 80 CRI, Tunable White

MECHANICAL/OPTICAL OPTIONS

ELECTRICAL OPTIONS

Uplight Options ID Only	Downlight	Voltage	Circuiting ²
TG - Top Glow (standard) F - Flush WSO - Widespread Optic WSOTG - Widespread Optic with Top Glow ASY-L - Asymmetric Left Optic ASY-R - Asymmetric Right Optic ASYTG-L - Asymmetric Left Optic with Top Glow ASYTG-R - Asymmetric Right Optic with Top Glow	MLW-CS - Micro Louver White Continuous MLB-CS - Micro Louver Black Continuous	120 - 120 Voltage 277 - 277 Voltage 347 - 347 Voltage	SC - Single Circuit* One single circuit in a run DC - Dual Circuit* ^{3,4} Independent control of up and down separately in an I/D style fixture MC - Multi-Circuit* More than one switch leg or zone. Factory shop drawings required

ELECTRICAL OPTIONS

MOUNTING OPTIONS

Driver Selection	Mounting Method ⁷
0-10V Driver Options FC-10% - 0-10V 10% (standard) FC-1% - 0-10V 1% OTI-10% - EldoLED OTi, 0-10V 10% ⁵ OTI-1% - EldoLED OTi, 0-10V 1% ⁵ ELD-10V-0% - EldoLED SOLOdrive, 0-10V 0.1% OTI-10V-TW - EldoLED OTi, 0-10V 10% (Tunable White) ⁵ DALI Driver Options FC-DALI-1% - DALI 1% DXL-DALI-1% - EldoLED Dexal, 1% ELD-DALI-0% - EldoLED SOLOdrive, 0.1% ELD-DALI-TW - EldoLED DUALdrive LightShape, 1% (Tunable White)	Lutron Driver Options LUT-ES1 - Lutron, Ecosystem 1% LUT-TW - Lutron T-Series, EcoSystem 0.1% (Tunable White)

MOUNTING OPTIONS

OTHER OPTIONS

Ceiling Hardware Type	Endcap Style	Finish	Emergency Style (Optional) See page 4 Backup Battery table
C1 - 15/16" T-Bar C1T - 15/16" Tegular ⁹ C2 - 9/16" T-Bar C2T - 9/16" Tegular ⁹ C3 - Screw Slot C3F - Flush Screw Slot	C4 - Hard Ceiling VF - Visible Flange ⁹ SF - Spackle Flange ⁹ TZ6 - Tech Zone 4" _____ (C1, C2, C2T, C3, C3F) ⁹	FE - Flat Endcap SW - Signal White FB - Finelite Black SA - Satin Aluminum #### - RAL Color Code ¹⁰ _____	LGD18W - Legrand 18W Brand Battery Back-up LGD10W - Legrand 10W Brand Battery Back-up EM/GEN - Emergency to Generator NL - Night Light BSL310LP - Bodine Battery Back up Low Profile GTD - Generator Transfer Device ALCR - Automatic Load Control Relay

For recessed fixtures with even grid lengths, there will be a 5 - 7/16" blank faceplate at each end of luminaire. See page 7 for more details

Battery packs not available for Surface Mount or Recessed luminaire.

OTHER OPTIONS

ACOUSTIC

Special Options (Optional)	Micro Louver	Micro Louver Light Output	Acoustic	Height	Acoustic Housing Color
CP - Chicago Plenum ⁹	8ML - Micro Louver	S - Standard (353 lm/ft) B - Boosted Standard (444 lm/ft) H - High (671 lm/ft) V - Very High (863 lm/ft)	ABL - Acoustic Baffle Lit	8H 12H	PEW - Pewter (standard) SLA - Slate (standard) #### - Letter Code ¹¹ _____ See Acoustic Technical Sheet for more details

lm/ft values shown are for white louvers. See page 9 for black louvers performance data

¹Pendant only
²Contact factory for switching options
³Indirect/Direct only
⁴DC and MC require 3' minimum
⁵Add DTO to gain "Dim to Off" functionality (FC-10% - DTO, FC-1% - DTO)
⁶B & V outputs only
⁷Pendant and Surface Mount only
⁸Direct only
⁹Recessed only
¹⁰20 business day lead time for color
¹¹Contact factory for lead time on acoustic color

Submitted by:		Date:
Type:	Project:	
Ordering Info:		

High Performance 2" Aperture (HP-2) Continuous Micro Louver

SUPPLEMENTARY DRIVER PAGE

0-10V Driver Options

FC-10%	Factory Choice, 0-10V 10% Dimming (Linear)
FC-10%-DTO	Factory Choice, 0-10V 10% Dimming, Dim-to-Off (Linear)
FC-1%	Factory Choice, 0-10V 1% Dimming (Linear)
FC-1%-DTO	Factory Choice, 0-10V 1% Dimming, Dim-to-Off (Linear)
ELD-10V-0%	EldoLED SOLOdrive, 0-10V 0.1% Dimming (Linear)
ELD-10V-1%	EldoLED ECOdrive, 0-10V 1% Dimming (Linear)
OTi-10V-TW	EldoLED OTi, 0-10V 10% Dimming, Tunable White (Linear)
OTi-10V-TW-DTO	EldoLED OTi, 0-10V 10% Dimming, Dim-to-Off, Tunable White (Linear)
OTi-10%	EldoLED OTi, 0-10V 10% Dimming (Linear)
OTi-10%-DTO	EldoLED OTi, 0-10V 10% Dimming, Dim-to-Off (Linear)
OTi-1%	EldoLED OTi, 0-10V 1% Dimming (Linear)
OTi-1%-DTO	EldoLED OTi, 0-10V 1% Dimming, Dim-to-Off (Linear)

DALI Driver Options

FC-DALI-1%	Factory Choice, DALI 1% Dimming (Logarithmic)
DXL-DALI-1%	EldoLED Dexal, DALI 1% Dimming (Logarithmic)
ELD-DALI-0%	EldoLED SOLOdrive, DALI 0.1% Dimming (Logarithmic)
ELD-DALI-1%	EldoLED ECOdrive, DALI 1% Dimming (Logarithmic)
ELD-DALI-TW	EldoLED DUALdrive Light Shape, DALI 0.1% Dimming, Tunable White (Logarithmic Dimming, Linear CCT Control)

Lutron Driver Options

LUT-ES1	Lutron, Ecosystem 1% Dimming
LUT-TW	Lutron T-Series, EcoSystem 0.1% Dimming, Tunable White

Submitted by:		Date:
Type:	Project:	
Ordering Info:		

High Performance 2" Aperture (HP-2) Continuous Micro Louver

SPECIFICATIONS

BODY TYPE

CONSTRUCTION: Precision-cut 6063-T6 extruded aluminum body. Internal joiner system and plug-together wiring are standard. Micro Louvers made from molded plastic.

LENGTHS: Any length, 2' minimum. Micro Louver increments of 1'.

OUTPUT and LED TYPE

LIGHT OUTPUT: Four lumen packages available, Standard (S), Boosted Standard (B), High (H), and Very High (V). For lengths 3' and greater, the uplight and downlight can be specified with different lumen packages and dual controls. For Tailored Outputs outside of range from Standard (S) to Very High (V), consult factory. Light engines are replaceable.

MECHANICAL/OPTICAL OPTIONS

UPLIGHT OPTION¹: Patented Top Glow frost white diffuser standard. 12' maximum diffuser length. 73% transmissive, 99% diffusion. Internal secondary diffusers at corners ensure visually seamless, uniform, continuous illumination. Options include: Flush frost white snap-in diffuser, 73% transmissive, 99% diffusion; Widespread Optic (WSO) and Widespread Optic with Top Glow (WSOTG); WSO enables increased luminaire spacing with improved ceiling uniformity. Asymmetric optic directs light in a specific direction. ASY-L distributes light to the left, ASY-R distributed light to the right of the luminaire. Consult factory for more tailored lumen outputs.

DOWNLIGHT OPTION: Micro Louvers (MLW/MLB) are white or black and can be specified in 1' increments that provide continuous illumination (CS). Consult factory for more tailored lumen outputs.

LUMEN MAINTENANCE: 90% of initial light output (L90) at 100,000+ hours; 70% of initial light output (L70) at 200,000+ hours.

ELECTRICAL OPTIONS

STATIC WHITE FEED: Standard with one 18-gauge/5-conductor single-circuit feed controlling uplight and downlight together (power and dimming). Specify dual feeds for independent control of uplight and downlight. 14-gauge feed used when luminaire current exceeds 5 amps.

STATIC WHITE DRIVER: Replaceable 120V, 277V, and 347V constant current reduction dimming driver standard. Can be wired dimming or non-dimming. 0-10V dimming controls with a range of 100%-10% standard. Dimming to 1% available. Separate dimming for uplight and downlight available. Driver is fully accessible from below the ceiling.

- **Power Factor:** ≥ 0.9
- **Total Harmonic Distortion (THD):** <20%
- **Expected driver lifetime:** 100,000 hours

LUTRON STATIC DRIVER OPTIONS:

- **LUT-ES1 (LDE1)** (Hi-lume 1% EcoSystem with Soft-On, Fade-to-Black dimming (LDE1 series))

MOUNTING OPTIONS

HANGING HARDWARE:

- **Pendant:** 50" Fully Adjustable (FA) plated steel aircraft cable with safety stop hardware standard. Contact factory for additional lengths up to 300". The Flexible Mounting Bracket (FM)² adjusts the suspension points to accommodate existing architecture. Suspension points adjust up to 2' in from the end of 8' and greater luminaire lengths and up to 1' in on shorter lengths.
- **Surface Mount:** Lay-in ceiling types: caddy clip with 1/4"-20 stud and nut. Drywall or concrete surfaces (walls or ceilings): 1/4"-20 stud and nut (provided by others).
- **Recessed Spackle Flange:** Drywall surfaces (walls or ceilings): 1/4"-20 stud and nut (provided by others).
- **Recessed T-Bar:** Standard bracket design works with most lay-in ceiling types. Brackets secure luminaire to the ceiling grid from above. Tie-in T-Bar brackets connect the luminaire to the T-Bar for securing to structure. Consult local codes for tie-wire recommendations. Continuous Micro Louver requires 5-7/16" blank face plates on each end that will match the selected luminaire finish to accommodate for standard even grid lengths.

OTHER OPTIONS

ENDCAPS: Flat diecast aluminum endcaps (FE) add 1/4" to each end of luminaire.

EMERGENCY STYLE: Optional emergency to generator/inverter wiring, internal generator transfer switch, nightlight wiring, step-dimming driver, backup battery. Factory choice low-profile backup battery available. Battery packs not available with Surface Mount or Recessed luminaire.

Backup Battery

	Legrand 18W	Legrand 10W/ Bodine BSL310LP
HP2-P-D		
Min. Housing Length	8' *	4' **
EM Lumen Output	1608	956
EM Section Illum.	2'	2' or 4'
HP2-P-ID		
Min. Housing Length	12'	8'
EM Lumen Output	1854	956
EM Section Illum.	2'	2' or 4'

* Minimum luminaire housing length for battery pack approved without sensor

** Exception: 5' not available, 6'+ okay

The lumens are based on 835. For other CCT/CRI, refer to the Lumen Adjustment Factor table on page 9.

Bodine GTD and Legrand ALCR Min. Length

Configuration	Min Length	
	ID, SM, R	D
Generator	6'	4'
Generator + OCC	8'	6'
Daylight	6'	4'
Generator + Daylight	8'	6'

¹ Indirect/Direct only
² Direct only

Submitted by:		Date:
Type:	Project:	
Ordering Info:		

High Performance 2" Aperture (HP-2) Continuous Micro Louver

SPECIFICATIONS

FINISHES: Finelite Signal White (**SW**) powder coat, Finelite Black (RAL 9005) with semi gloss fine texture (**FB**), and Satin Aluminum (**SA**) are standard. Optional Adder: 179 RAL colors ³ are available.

LABELS: Luminaire and electrical components are ETL-listed conforming to UL 1598 in the U.S.A. and CAN/CSA C22.2 No. 250.0 in Canada. In accordance with NEC Code 410.130 (G), this luminaire contains an internal driver disconnect. UL 924 and UL 2108 - PoE options available on request. These luminaires are rated for Damp Location. Finelite products use electronic components that are RoHS compliant, and the mechanical components of the luminaire have been verified to not knowingly contain any restricted substances listed per RoHS Directive 2015/863. Consult factory for tailored lighting options.

WEIGHT⁴: ID - 2.9 lb/ft; D - 2.3 lb/ft.

WARRANTY: 10-year performance-based warranty on all standard components. Optional accessories such as emergency battery packs are covered by their individual manufacturer warranties.

³ 20 business days lead time for color

⁴ Excludes Battery Back up and Generator Transfer Device weight

Submitted by:		Date:
Type:	Project:	
Ordering Info:		

High Performance 2" Aperture (HP-2) Continuous Micro Louver

GLARE CONTROL APPLICATION*

ID	PERFORMANCE				UNIFIED GLARE RATING			
	Luminaire	Lum. Lumens	Lum. Watts	LLD	LDD	Avg.	Max.	Min.
HP-2-P-D-MLB		2422	36.2	1,000	1,000	10.0	10	10
HP-2-P-D-MLW		3181	36.2	1,000	1,000	13.0	17	10

Ceiling height: 12'0" AFF
Luminaire mounting height: 10'0" AFF to bottom of luminaire
Room reflectances: 80/50/20
UGR grid is at 3.92' AFF
Horizontal Viewing Angle: 45°/

Micro Louver Continuous Black

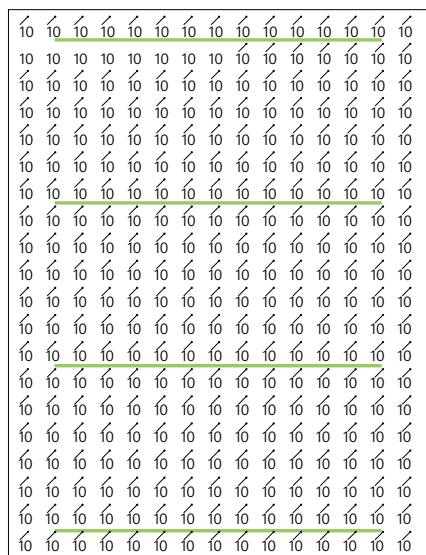

AVERAGE
UGR
10

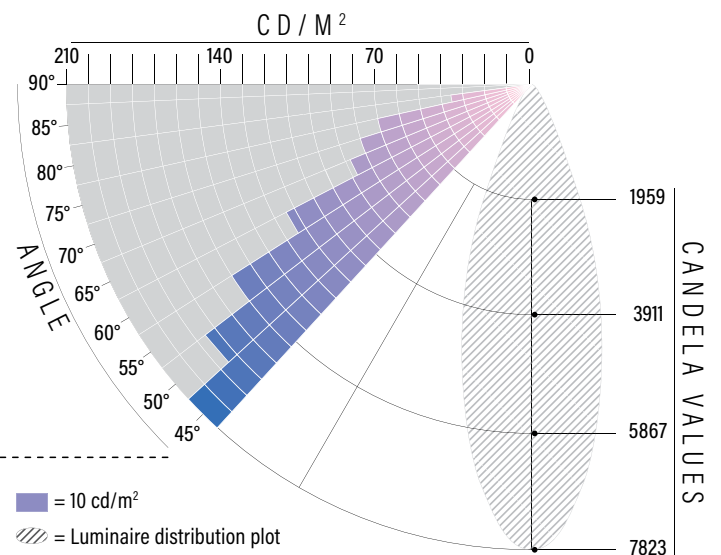
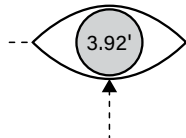

Micro Louver Continuous White

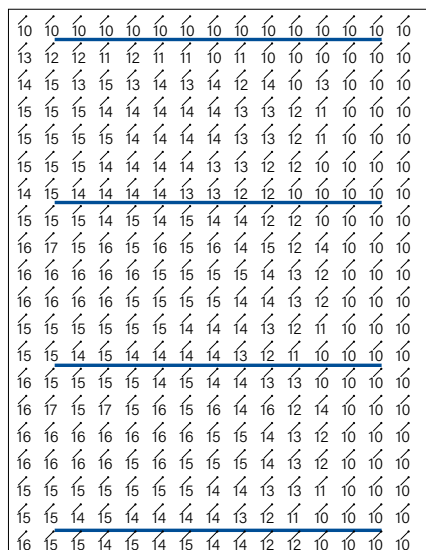

AVERAGE
UGR
13

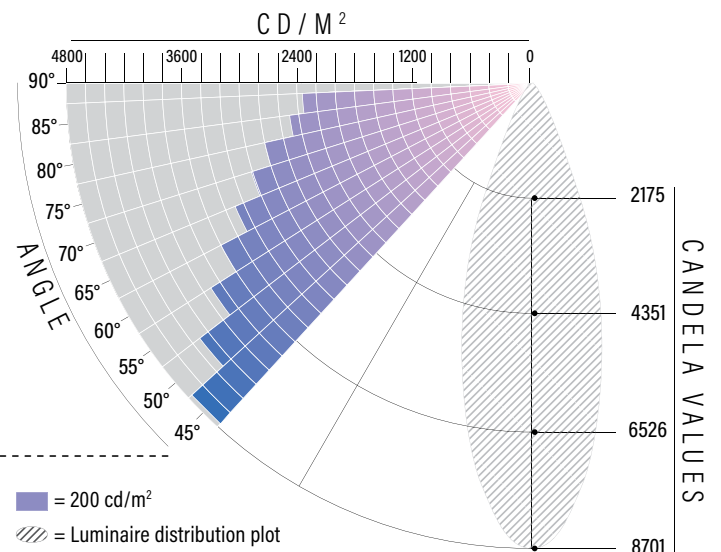
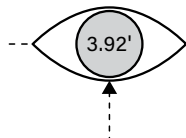

*Room calculations based on Micro Louver continuous luminaire, recommended to follow LEED v4.1, WELL L07 calculation strategies

Submitted by:		Date:
Type:	Project:	
Ordering Info:		

High Performance 2" Aperture (HP-2) Continuous Micro Louver

HARD CEILING MOUNTING OPTIONS

Threaded Rod Option

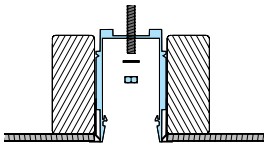

Mounting Location for Securing to Structure

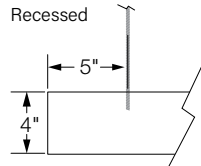

Screw Mount Option

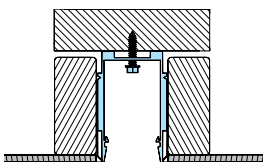

Two mounting options: threaded rod and screw mounting options. Mounting locations are located on each end of the luminaire. Mounting location is 5" away from each end of luminaire.

T-BAR INSTALLATION

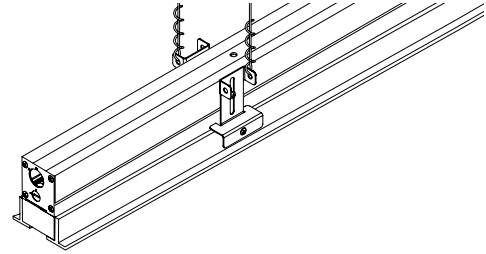

HP-2 R for T-Bar installations comes standard with a splice plate at the end of the luminaire. Mounting brackets (supplied) secure the luminaire to T-Bar and provide support to structure location. All even foot length (2, 4, 6, ...) luminaire runs are reduced in length by an appropriate amount to fit within typical 2x2 and 2x4 T-Bar grid systems. Continuous Micro Louver requires 5-7/16" blank face plates on each end that will match the selected luminaire finish to accommodate for standard even grid lengths. For uncommon T-Bar systems please consult factory.

GRID LENGTH DETAIL - 4' Example

Blank Section

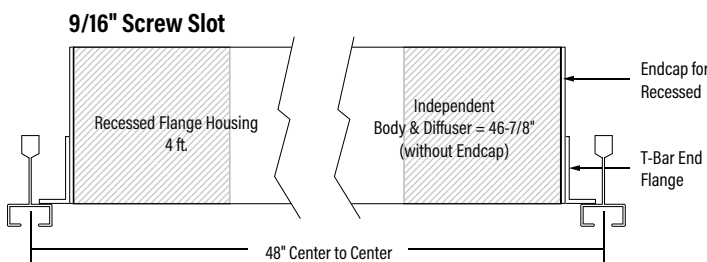
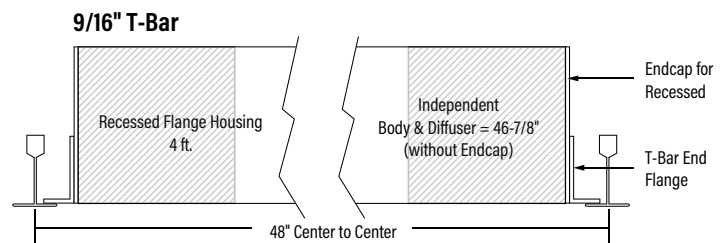
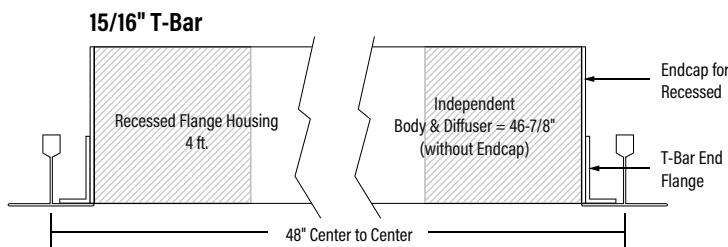

Standard Continuous Grid Lengths

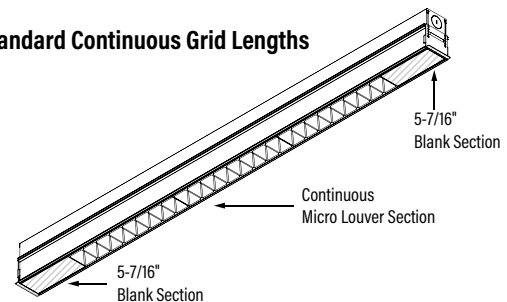

HARD CEILING LENGTH DETAIL - 4' Example

Spackle Flange

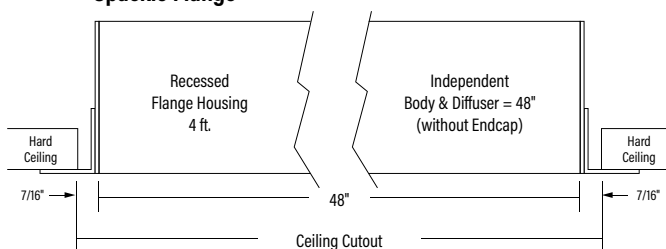

Visible Flange

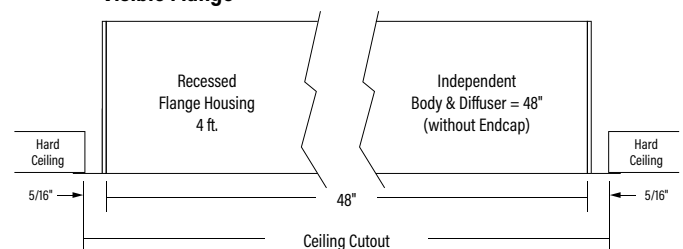

Submitted by:		Date:
Type:	Project:	
Ordering Info:		

High Performance 2" Aperture (HP-2) Continuous Micro Louver

RECESSED MOUNTING TYPES - T-Bar

Rough-In Dimensions

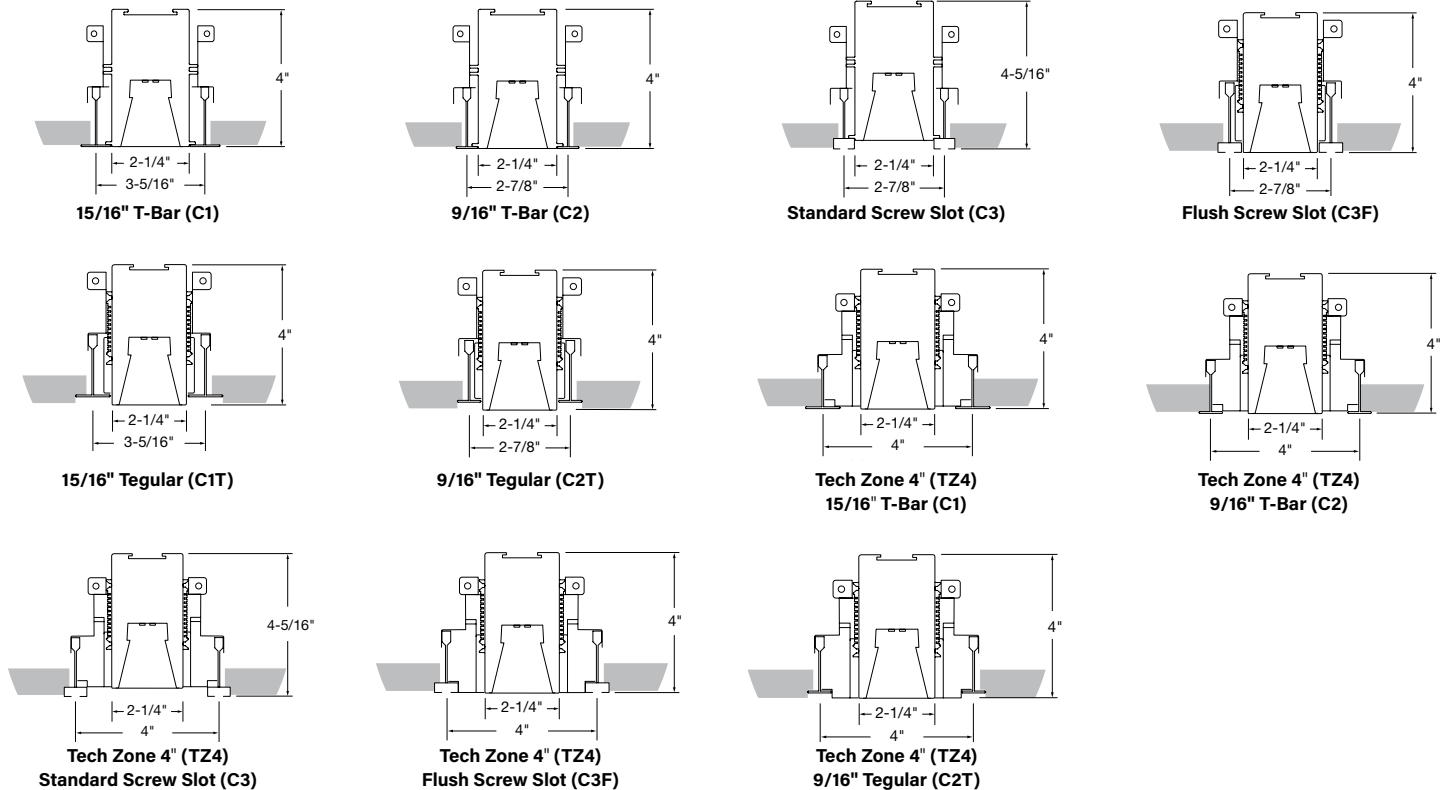

RECESSED MOUNTING TYPES - Cutout Dimensions

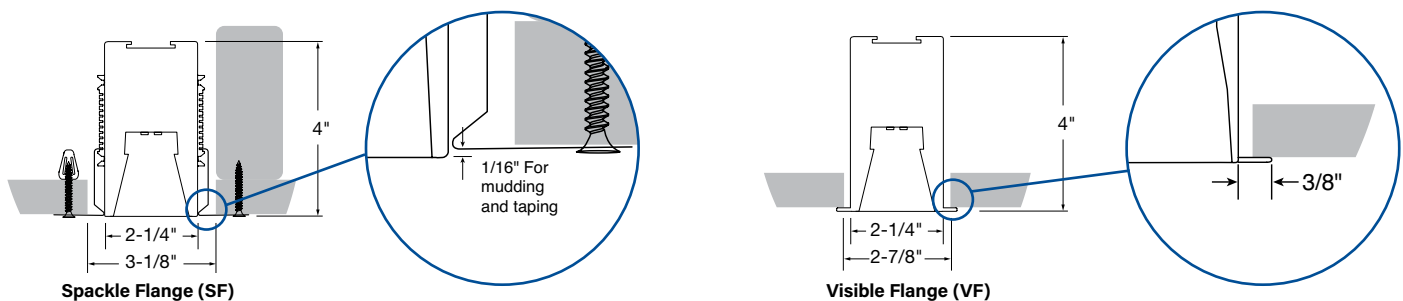

HOUSING

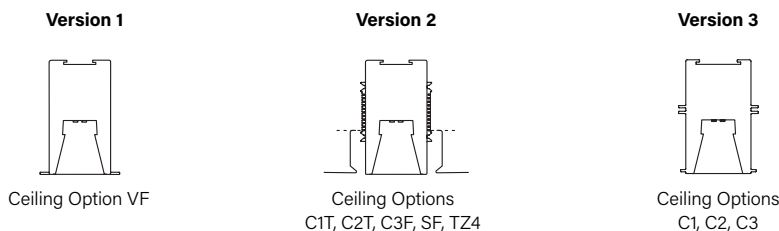

Note: +/- 1/16"

Submitted by:		Date:
Type:	Project:	
Ordering Info:		

High Performance 2" Aperture (HP-2) Continuous Micro Louver

Micro Louver Direct Photometry - 4' Luminaire 3461K

HP2-P-D-MLW-CS-V-835

Downlight: White Micro Louver Continuous

Efficacy: 96 lm/W

Total luminaire output: 3452 lumens (863 lm/ft)
36.1 watts (9.0 W/ft)

Peak Candela Value: 8701 @ 0°

CRI: 80 / CCT: 3461K

NLTL LM79 Report REP-021122.01

LM63 Report KPL2008-7

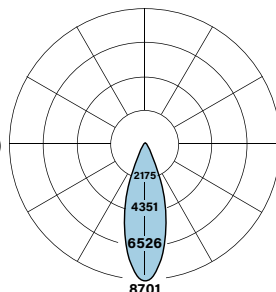

Micro Louver Direct Photometry - 4' Luminaire 3472K

HP2-P-D-MLB-CS-V-835

Downlight: Black Micro Louver Continuous

Efficacy: 68 lm/W

Total luminaire output: 2449 lumens (612 lm/ft)
36.0 watts (9.0 W/ft)

Peak Candela Value: 7823 @ 0°

CRI: 80 / CCT: 3472K

NLTL LM79 Report REP-021122-02

LM63 Report KPL2008-6

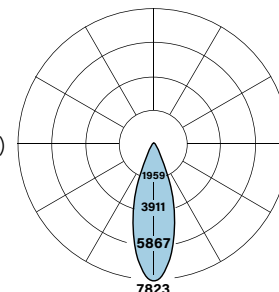

Total Light Output, 3500K, 80 CRI (Lumens) - 4' Luminaire

S ¹	B ¹	H ¹	V ²
1413	1776	2685	3452

Light Output, 3500K, 80 CRI (Lumens Per Foot)

S ¹	B ¹	H ¹	V ²
353	444	671	863

Power, 3500K (Watts Per Foot)

S ¹	B ¹	H ¹	V ²
3.5	4.5	6.9	9.0

Efficacy, 3500K, 80 CRI (Lumens Per Watt)

S ¹	B ¹	H ¹	V ²
100	99	97	96

Total Light Output, 3500K, 80 CRI (Lumens) - 4' Luminaire

S ¹	B ¹	H ¹	V ²
1003	1260	1905	2449

Light Output, 3500K, 80 CRI (Lumens Per Foot)

S ¹	B ¹	H ¹	V ²
251	315	476	612

Power, 3500K (Watts Per Foot)

S ¹	B ¹	H ¹	V ²
3.5	4.5	6.9	9.0

Efficacy, 3500K, 80 CRI (Lumens Per Watt)

S ¹	B ¹	H ¹	V ²
71	70	69	68

S - Standard Output, B - Boosted Standard Output, H - High Output, V - Very High Output

1 Family Correlation based on 4' luminaire 3461K Very High Output (V) test - 120V.

2 Based on NLTL report: LM79 Report REP-021122.01 and LM63 Report KPL2008-7

S - Standard Output, B - Boosted Standard Output, H - High Output, V - Very High Output

1 Family Correlation based on 4' luminaire 3472K Very High Output (V) test - 120V.

2 Based on NLTL report: LM79 Report REP-021122.02 and LM63 Report KPL2008-6

Wattage is Real Power. If you would like additional details to calculate Apparent Power, please contact your local Finelite representative.

Sample Lumen Adjustment Calculation

Lumen Adjustment Factors 80 CRI

3000K	0.985
3500K	1.000
4000K	1.032

Lumen Adjustment Factors 90 CRI

3000K	0.746
3500K	0.760
4000K	0.789

High Output (H), 4000K, 90 CRI

Lumen Adjustment Factor: 0.789

Total Light Output: 2685 lm x 0.789 = 2118 lm

Total Light Output per Foot: 671 lm/ft x 0.789 = 529 lm/ft.
watts/foot: 6.9 W/ft.

$$\text{Efficacy} = \frac{529 \frac{\text{lm}}{\text{ft.}}}{6.9 \frac{\text{W}}{\text{ft.}}} = 73 \text{ lm/W}$$

Submitted by:		Date:
Type:	Project:	
Ordering Info:		

0-10V Tunable White

Finelite's award-winning, contractor friendly Tunable White luminaires are available at low cost, with powerful and simple 0-10V tuning and intensity controls.

TUNABLE WHITE FEATURES

- CCT range: 2700K - 6500K
- Dimming Range: 100% to 10%
- CRI Options: 80 CRI or 90 CRI

PHOTOMETRY

Apply a power adjustment factor to calculate wattage usage

POWER	CONVERSION FACTOR
	1.1X

(Example: a 50 watt luminaire in static white would draw 55 watts using 0-10V Tunable White)

LUMINAIRE FAMILY MODIFICATIONS/RESTRICTIONS

Direct	Section Lengths											
	2'	3'	4'	5'	6'	7'	8'	9'	10'	11'	12'	
Output S,B,H,V Single Circuit	Rows can be comprised of 2'-12' sections.											
Integral Battery Backup (BSL310LP)							✓		✓		✓	
Indirect/Direct												
Output S,B Single Circuit	✓	✓	✓	✓	✓	✓	✓	✓	✓	✓	✓	✓
Integral Battery Backup (BSL310LP)							✓		✓		✓	✓
Output H,V Single Circuit			✓				✓				✓	✓
Integral Battery Not Available	Remote Battery backup solution available. Consult factory for tailored lighting options.											
Output S,B,H,V Dual Circuit			✓				✓				✓	✓
Integral Battery Not Available	Remote Battery backup solution available. Consult factory for tailored lighting options.											

EN/GEN sections available for all body lengths

WIRING DIAGRAM - DIMMABLE TO 10%

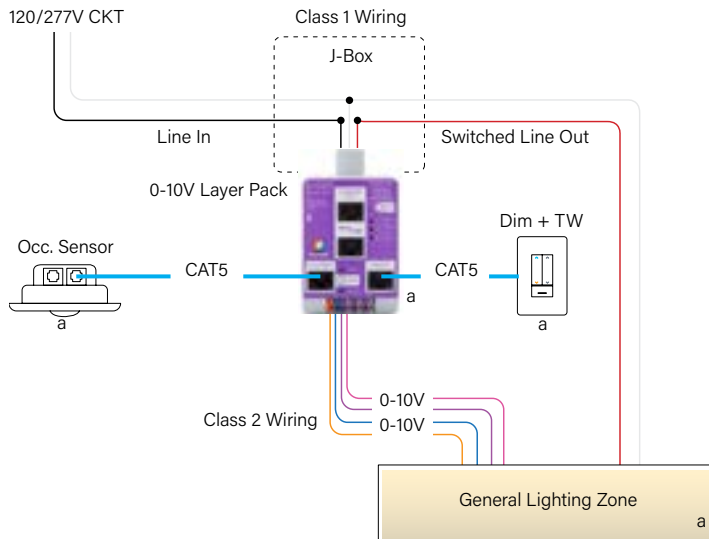

Luminaire Wiring

- **Purple (+) / Pink (-)** control wires are for intensity control
- **Orange (+) / Blue (-)** control wires are for Tunable White control

Note:

Load or Dim to Off options available.

DUAL FEED DETAIL

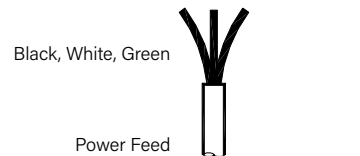

WIRING LEGEND		
Black	Hot	Line Voltage
White	Neutral	Line Voltage
Green	Ground	

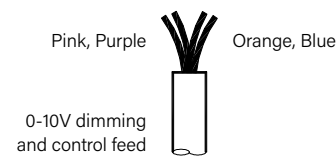

WIRING LEGEND		
Pink	Dimming	0-10V DC
Purple	Dimming	0-10V DC
Orange	TW	0-10V DC
Blue	TW	0-10V DC

