

HP-4 Wet Location Direct Installation Instruction Overview

NOTES

- All power connections should be installed according to local/national codes by a Certified Electrician.
- This installation requires **proper support** as each luminaire is being installed.
- **DO NOT attempt to join luminaires together on the floor.** Damage may result when lifted.



HELPFUL VIDEOS



Effortless Access



0-10V Dimming



Universal & Robust Joints



Simple Plug-Together Wiring

Step 1
Mounting & Suspension
Page 2

Step 2
Identification & Preparation
Page 3

Step 3
Mounting Starter to Structure
Page 4

Step 4
Opening Luminaires
Page 5

Step 5
Joining Luminaires
Page 6

Step 6
Securing Luminaire Joints
Page 7

Step 7
Closing Luminaires
Pages 8

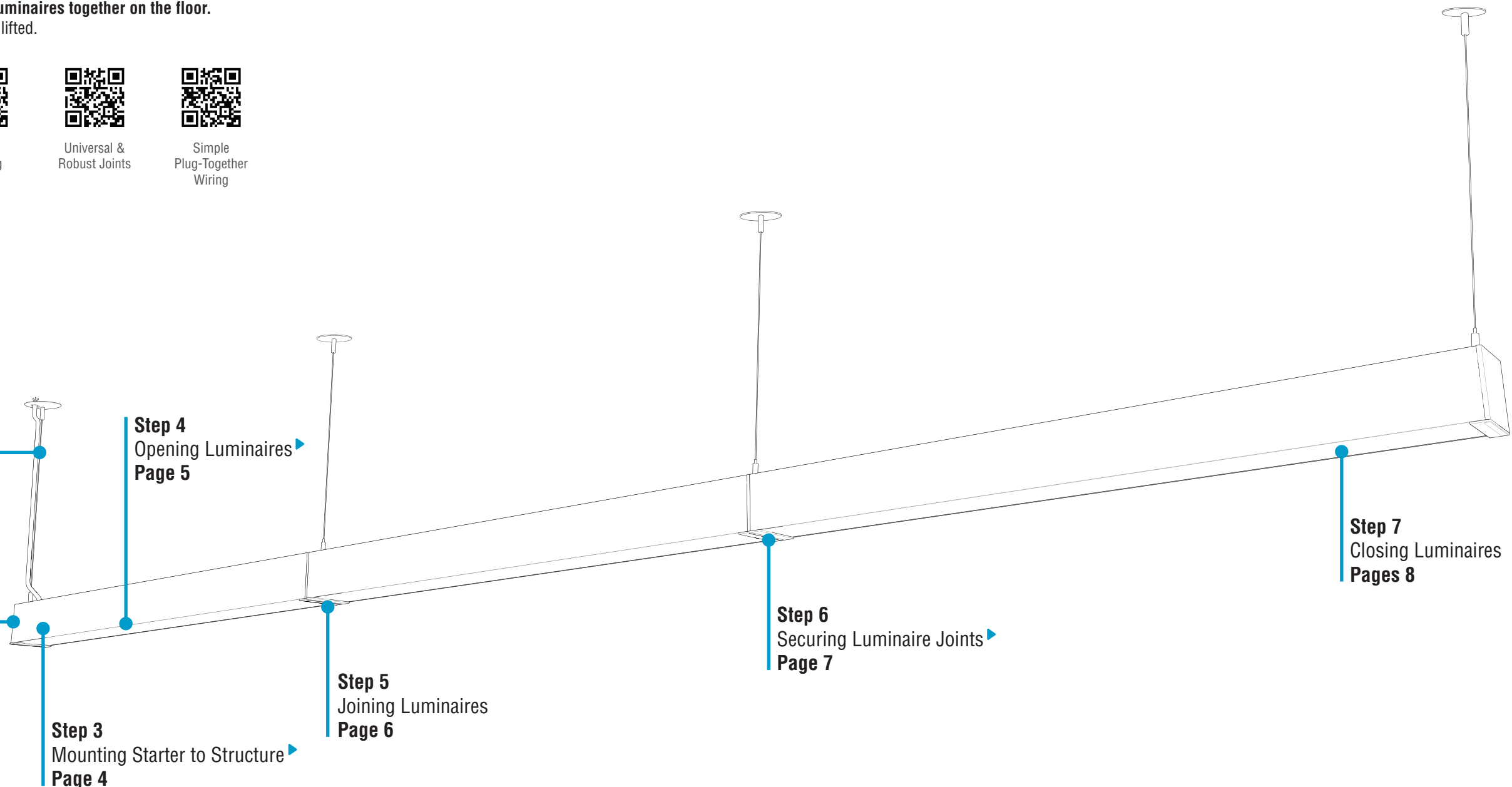

HP-4 Wet Location Direct Installation Instruction

Step 1 - Mounting & Suspension

Mounting Options

Drywall (C4) or other hard surfaces* - Wet Rated J-Box and Anchor Bolts

- Install wet rated J-Box and wet rated electrical conduit at feed locations.
- Install anchor bolts at mounting point locations.
- All anchor bolts are to be secured to structure, per local building codes.

* Other hard surfaces include: wood, sheet metal panels, steel beams, concrete, or masonry. Use hardware appropriate for each surface material type.

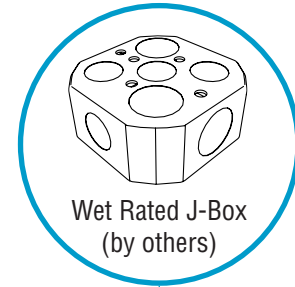

Suspension Locations

X = Suspension Dimensions

Refer to Record Drawings and building plans to determine exact mounting, suspension points, and power feed locations.

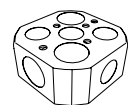
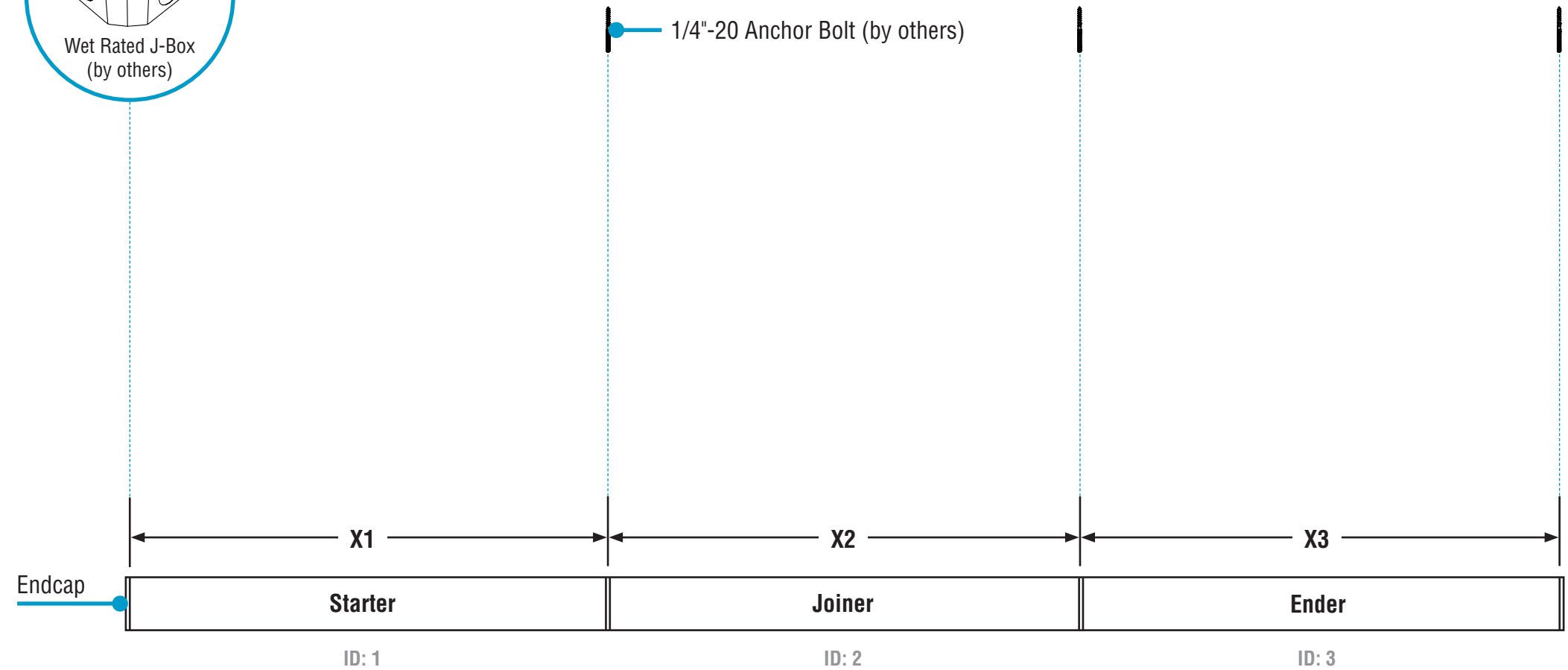

Wet Rated J-Box
(by others)



1/4"-20 Anchor Bolt
(by others)

HP-4 Wet Location Direct Installation Instruction

Step 2 - Identification & Preparation

A. Identify Luminaires



Arrange luminaires in order according to ID# at their install locations.

CAUTION

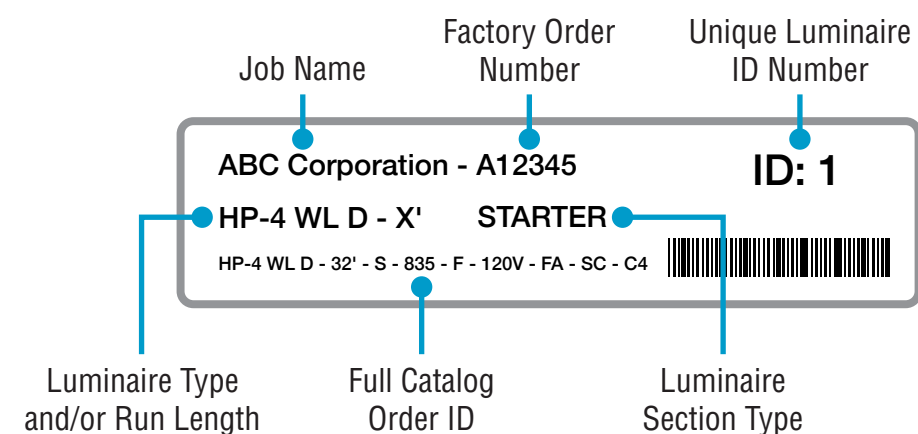

- Identify all luminaires by their ID label that can be found on the box, the diffuser, and inside the luminaire.
- **NOTE:** Exact location of labels in these areas may vary.
- Remove all luminaires from their box.
- Refer to Record Drawings that can be found in the hardware kit.

B. Remove Diffusers Top-Down View

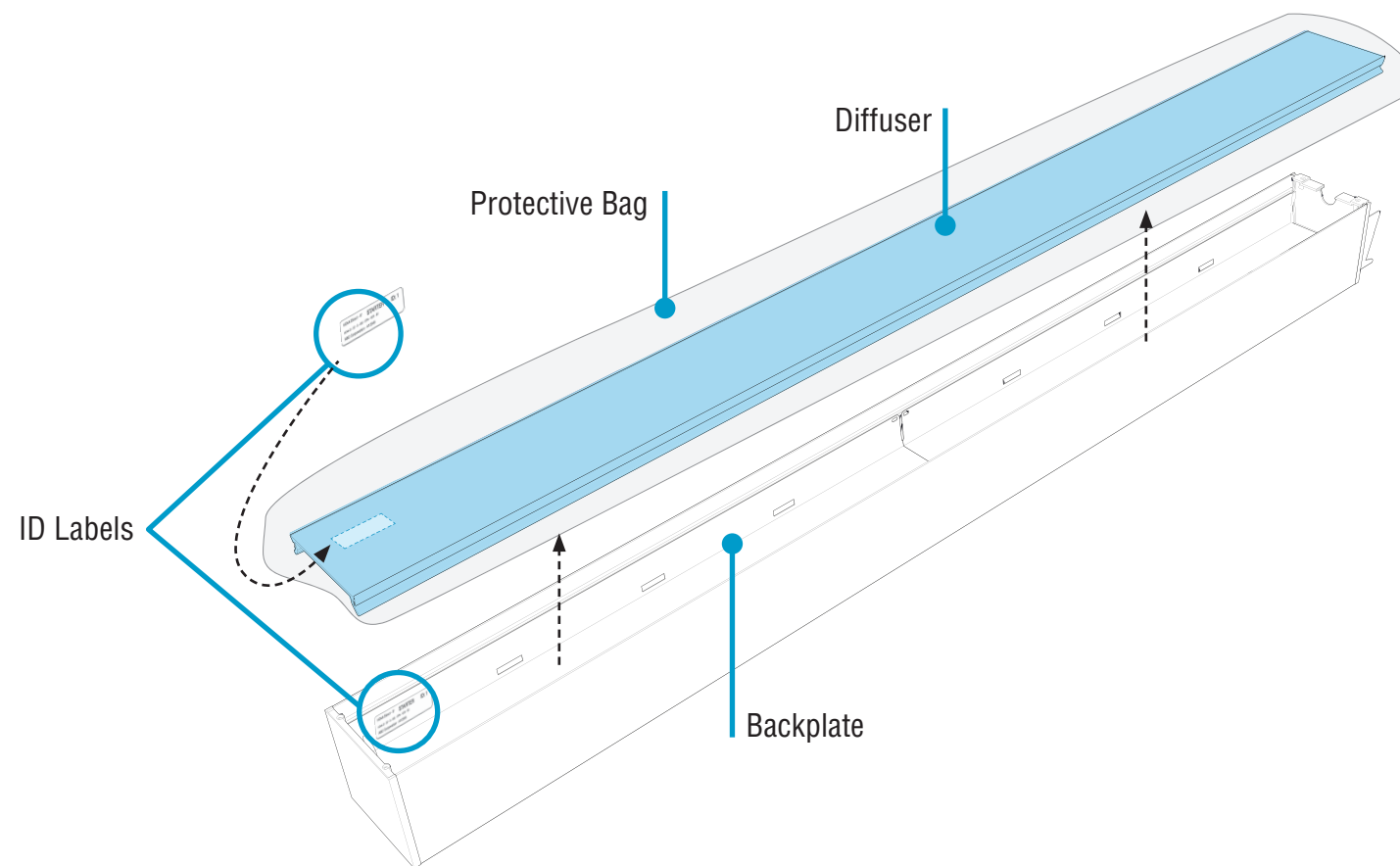

- Carefully remove all diffusers, keeping them inside their protective bags.
- Set aside all diffusers to prevent them from getting dirty or damaged.
- Ensure diffusers can be clearly identified back to their corresponding luminaire.

Kitted Hardware

- Finelite has provided items listed here, with their Finelite part numbers. These items can be found in separate boxes shipped with the luminaire.
- Account for all parts and set aside until they are needed.
- All other hardware needed for this installation will be by others.

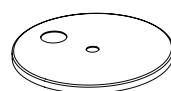

5" Canopy
Part# 94085



2" Drywall Support Canopy
Part# 94017
Mounting Starter to Structure p. 4, Step 3
Joining Luminaires p. 5, Step 4

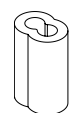

Safety Crimp
Part# 94514
Closing Luminaires p. 8, Step 7

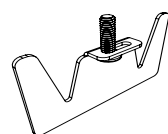

Yoke Bracket
Part# 43659



Washer
Part# 94111

#10-32 x 5/8" Screw
Part# 94144
Securing Luminaire Joints p. 7, Step 6



Gripper
Part# 43700
Mounting Starter to Structure p. 4, Step 3
Joining Luminaires p. 5, Step 4



Cable Bushing
Part# 94014



Aircraft Cable
50" - Part# 94515-12 (Std.)
100" - Part# 94515-14
150" - Part# 94515-18
Mounting Starter to Structure p. 4, Step 3
Joining Luminaires p. 5, Step 4

Slip Ring w/ Set Screw
Part# 94015
Mounting Starter to Structure p. 4, Step 3
Joining Luminaires p. 5, Step 4



Diffuser Screw
#6-32 x 3/8" Screw - Part# 76404
Identification & Preparation p. 3, Step 2
Closing Luminaires p. 8, Step 7

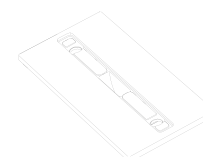

Joint Diffuser Cover
Part# 43740
Identification & Preparation p. 3, Step 2
Closing Luminaires p. 8, Step 7



Screw Cover
Part# 43637
Identification & Preparation p. 3, Step 2
Closing Luminaires p. 8, Step 7

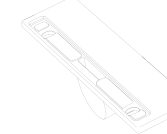

Endcap Diffuser Cover
Part# 43738
Identification & Preparation p. 3, Step 2
Closing Luminaires p. 8, Step 7



Effortless Access

HP-4 Wet Location Direct Installation Instruction

Step 3 - Mounting Starter to Structure

A. Mount Starter to Structure Bottom-Up View

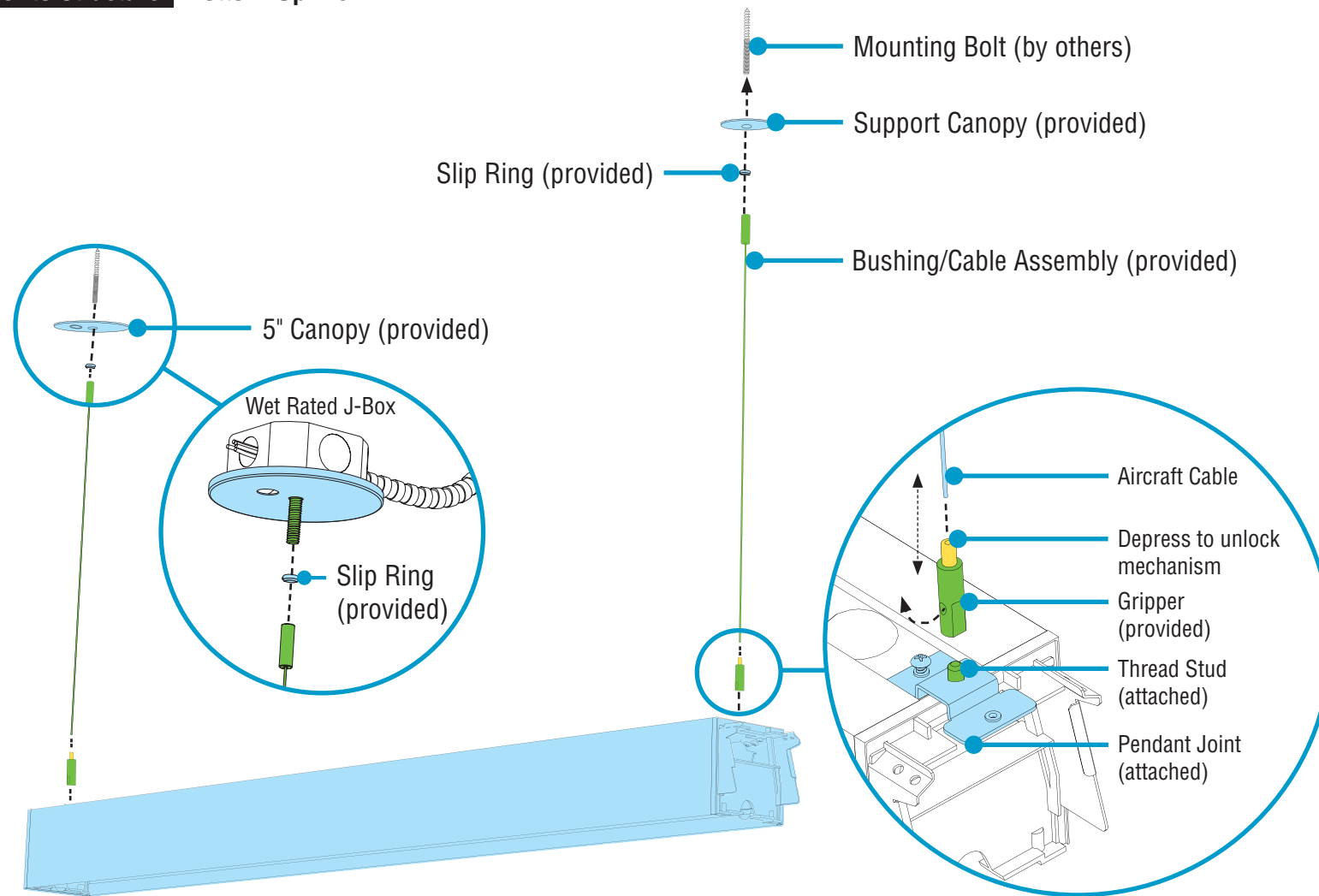

- Slide slip ring onto bushing/cable assembly and thread onto mounting bolts. Secure slip ring with set screw at both mounting locations.
- Attach grippers onto threaded studs found on end plates of starter luminaire.
- While properly supporting luminaire, maneuver luminaire to ceiling.
- Turn the top grip on gripper counter clockwise to unlock.
- Depress the top of the gripper to feed the aircraft cable through.
- Turn the grip clockwise to lock aircraft cable.
- **CRITICAL:** Level each luminaire section. If part of an independent run, **PROCEED TO STEP 7.**

B. Make Electrical Connections Bottom-Up View

WIRING LEGEND		
Black	Hot	Line Voltage
White	Neutral	Line Voltage
Green	Ground	
Pink	Dimming	0-10V DC
Purple	Dimming	0-10V DC

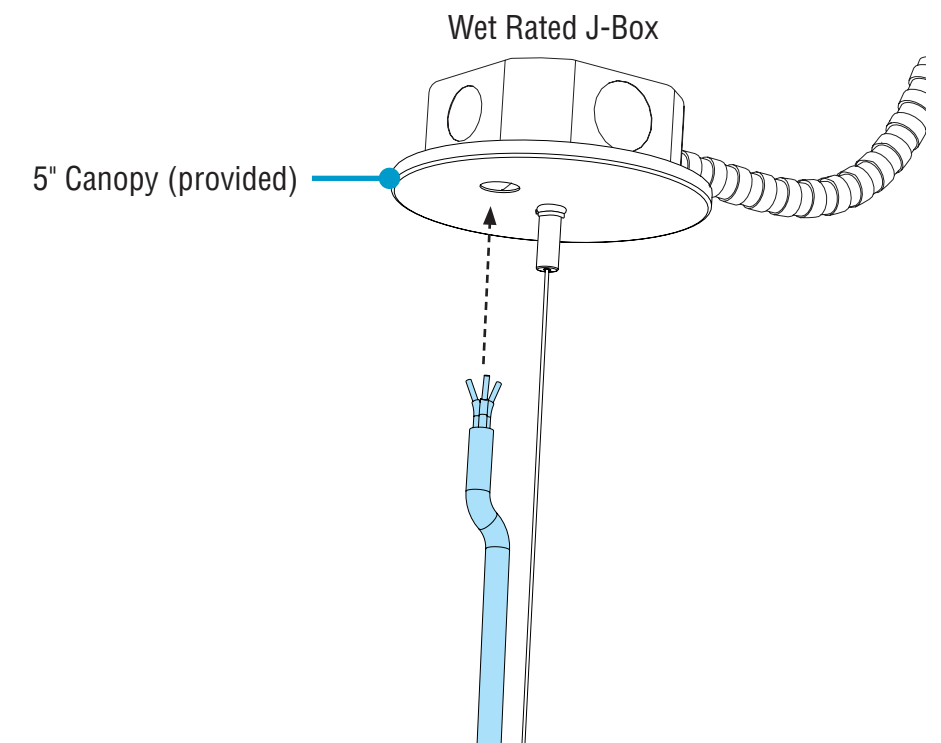

- Feed power cord through the 5" canopy and connect wires inside the wet rated J-Box.

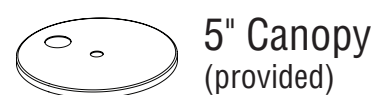

5" Canopy (provided)

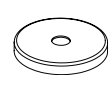

2" Drywall Support Canopy (provided)



Slip Ring w/ Set Screw (provided)



Bushing/Cable Assembly (provided)



Gripper (provided)



0-10V Dimming

HP-4 Wet Location Direct Installation Instruction

Step 4 - Opening Luminaires

Release Backplates Bottom-Up View

Putty Knife Option

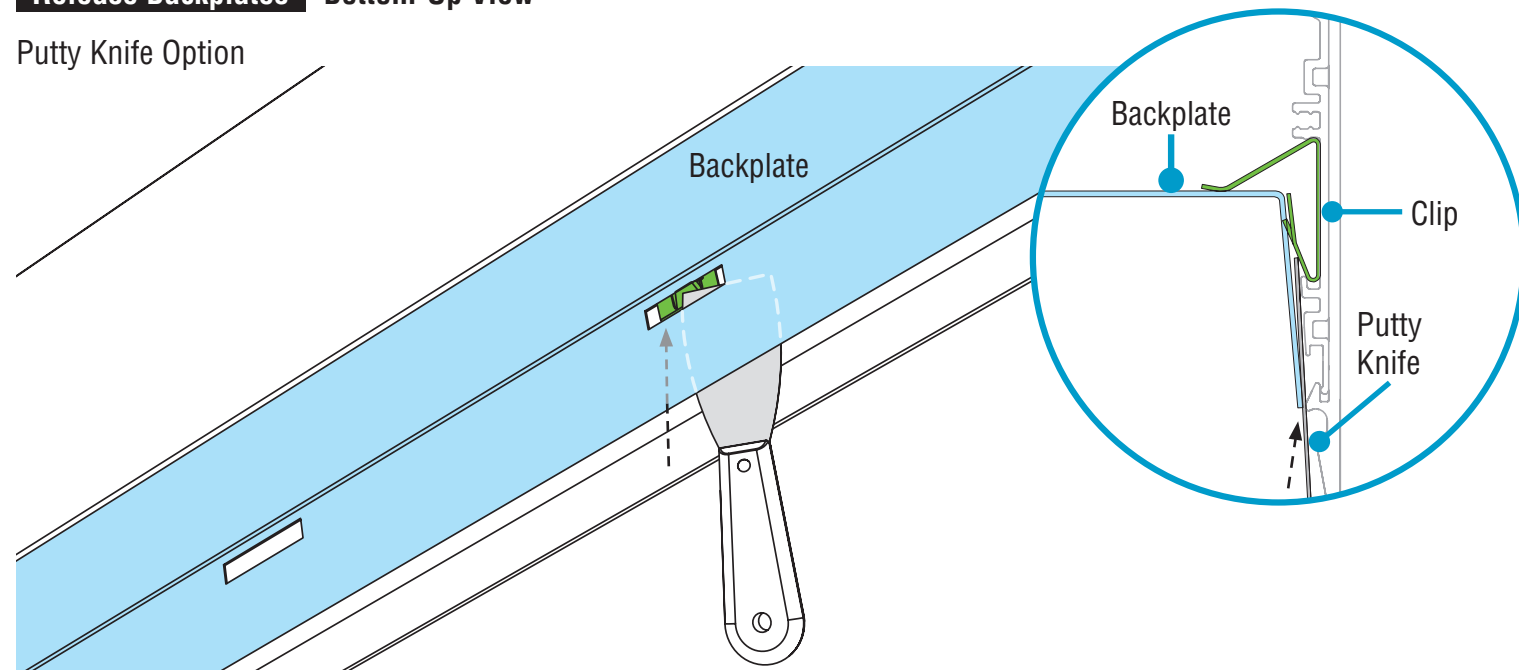

Flathead Screwdriver Option

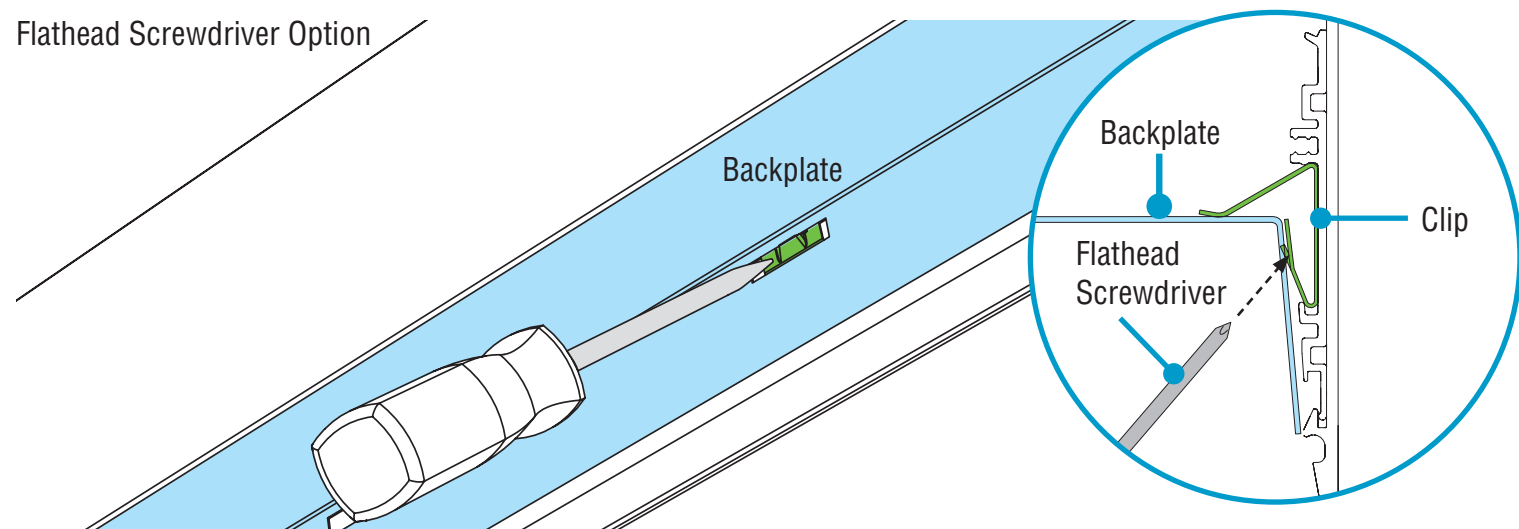

- **NOTE:** For independent luminaires, backplates do not need to be released.
- Release the backplates from clips by sliding the blade of a putty knife behind backplate edges.
- To use a flathead screwdriver, press end of screwdriver (from inside the luminaire) against the clip, until the backplate is released.

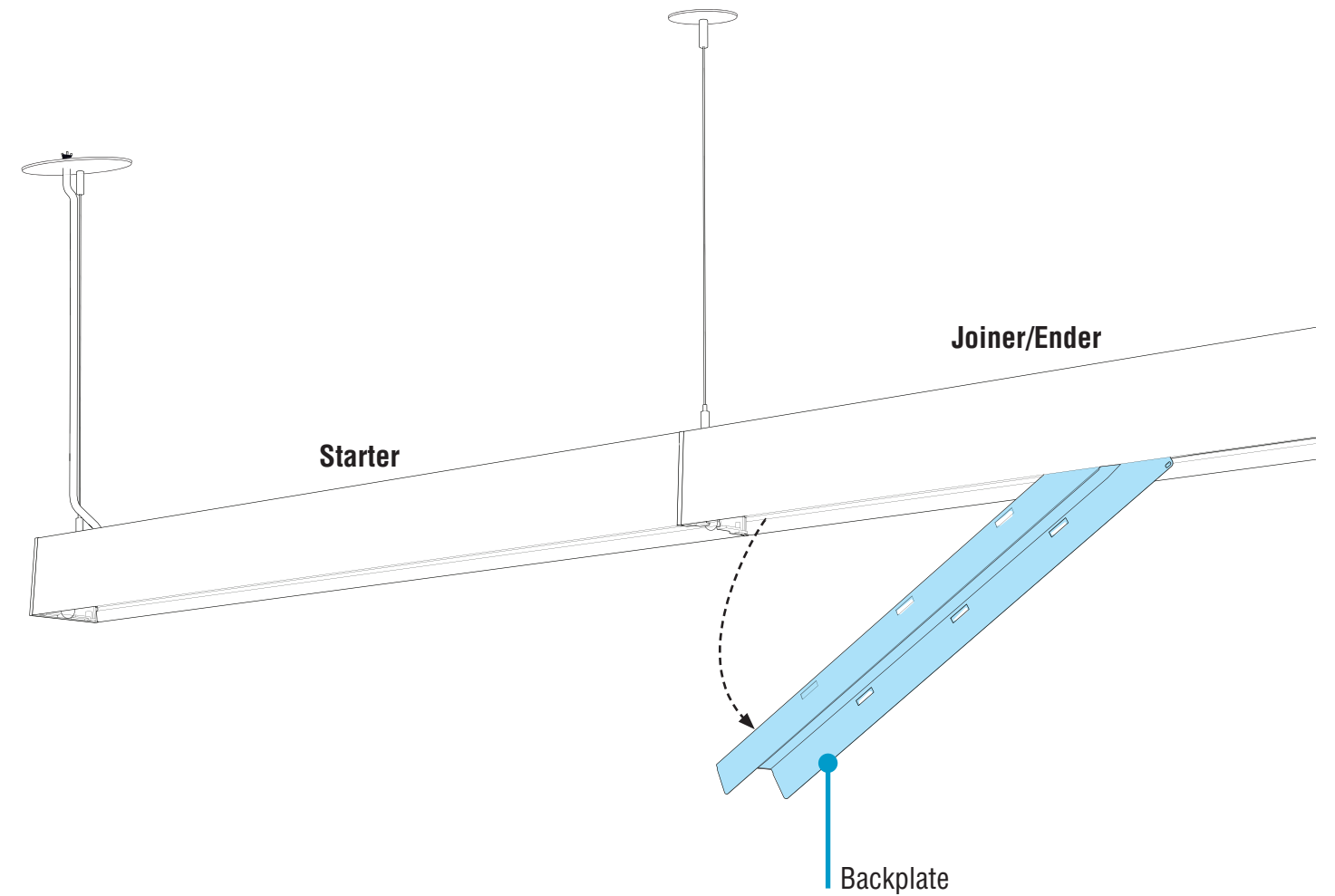

- Carefully rotate backplate out at joint only and let it hang from luminaire body.



Effortless
Access

HP-4 Wet Location Direct Installation Instruction

Step 5 - Joining Luminaires

A. Mount Joiner/Ender to Structure Bottom-Up View



CAUTION

DO NOT attempt to join luminaires together on the floor. Damage may result when lifted. Follow these instructions.

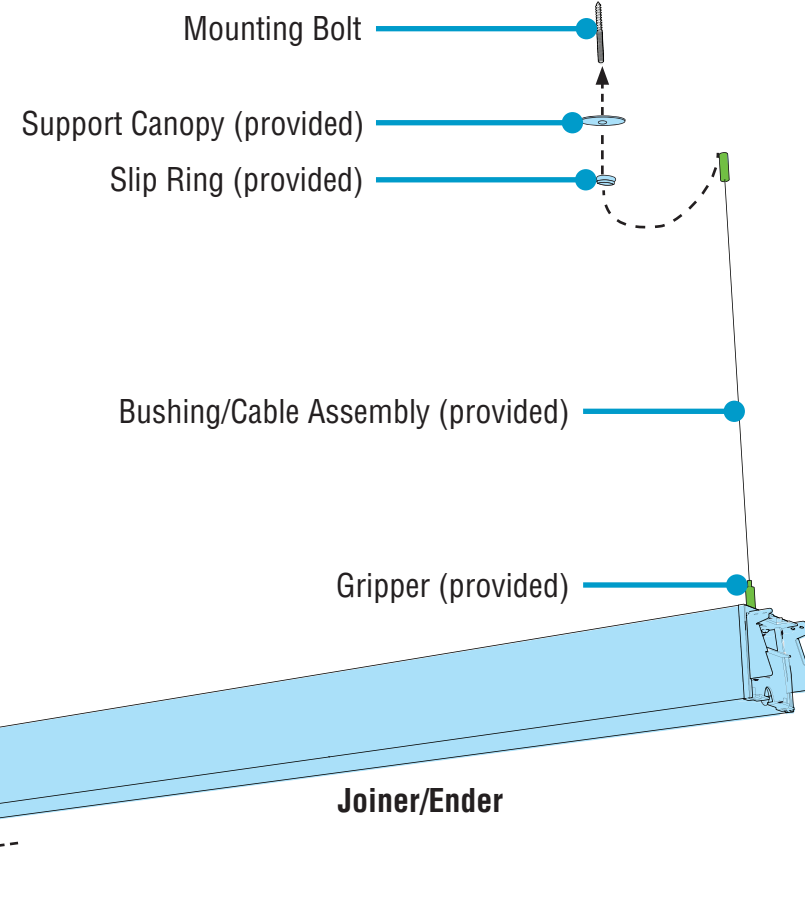

- For the joiner/ender luminaire, slide canopy appropriate for electrical type onto mounting bolt.
- Thread the bushing/cable assembly onto mounting bolt.
- Attach grippers onto threaded studs found on end plates of joiner/ender.
- While properly supporting luminaire, maneuver luminaire to ceiling.
- Turn the top grip on gripper counter clockwise to unlock.
- Depress the top of the gripper to feed the aircraft cable through.
- **CRITICAL:** Level each luminaire section.
- Turn the grip clockwise to lock aircraft cable.

B. Join Luminaires Bottom-Up View



CAUTION

Once luminaires are aligned together, **joiner luminaire is not yet secure.** Ensure it does not slide off as it rests on the starter luminaire.

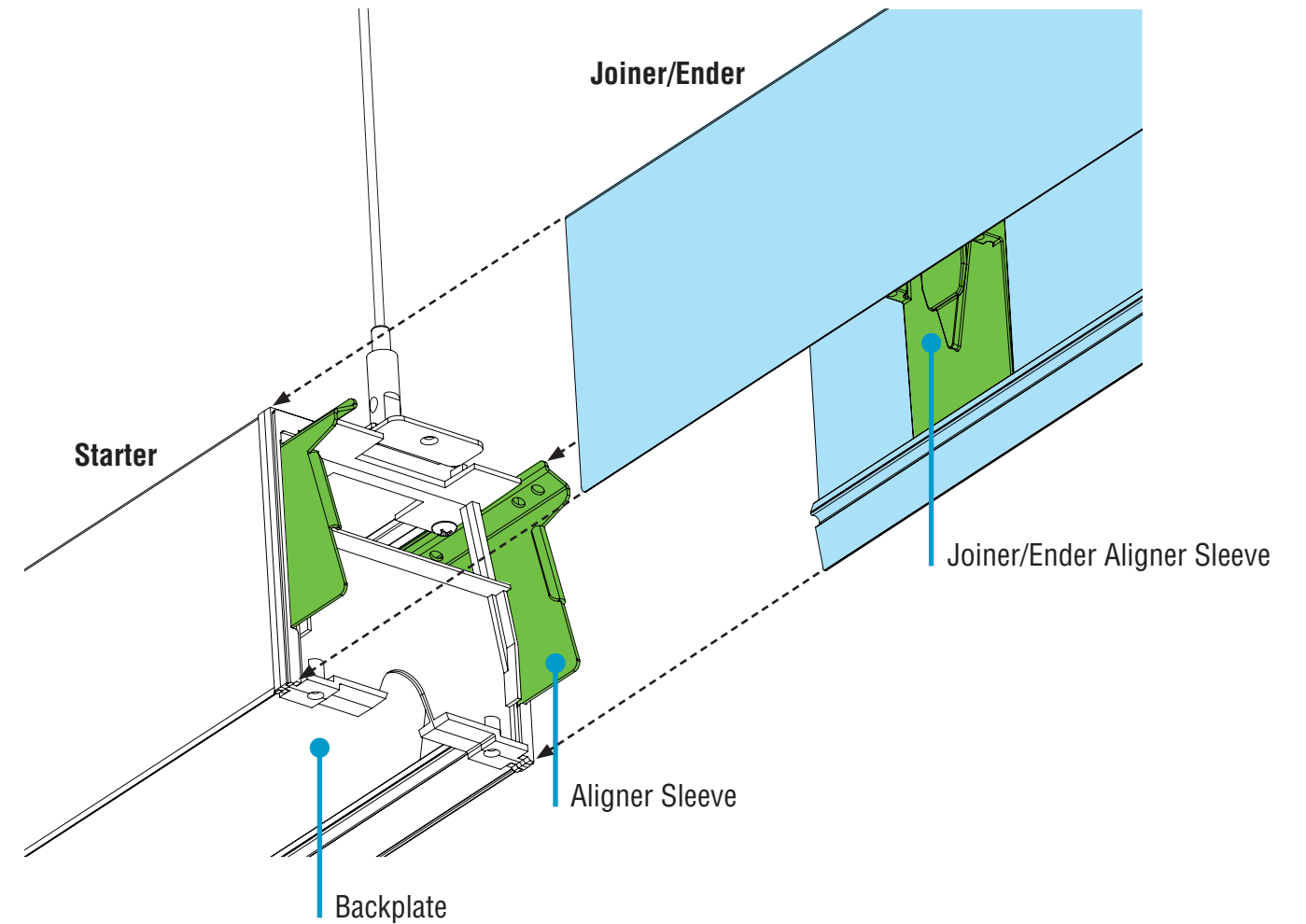

- Align joiner/ender with aligner sleeves on starter and slide together. Be careful not to damage any wiring.
- If necessary, **lift** both luminaires, then slide together.

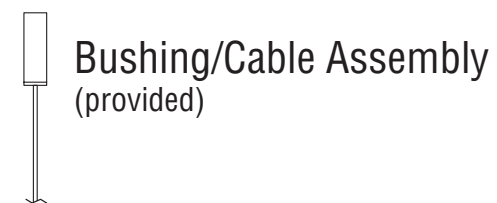
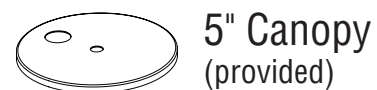

Universal & Robust Joints

HP-4 Wet Location Direct Installation Instruction

Step 6 - Securing Luminaire Joints

A. Secure Joint with Yoke Brackets Bottom-Up View

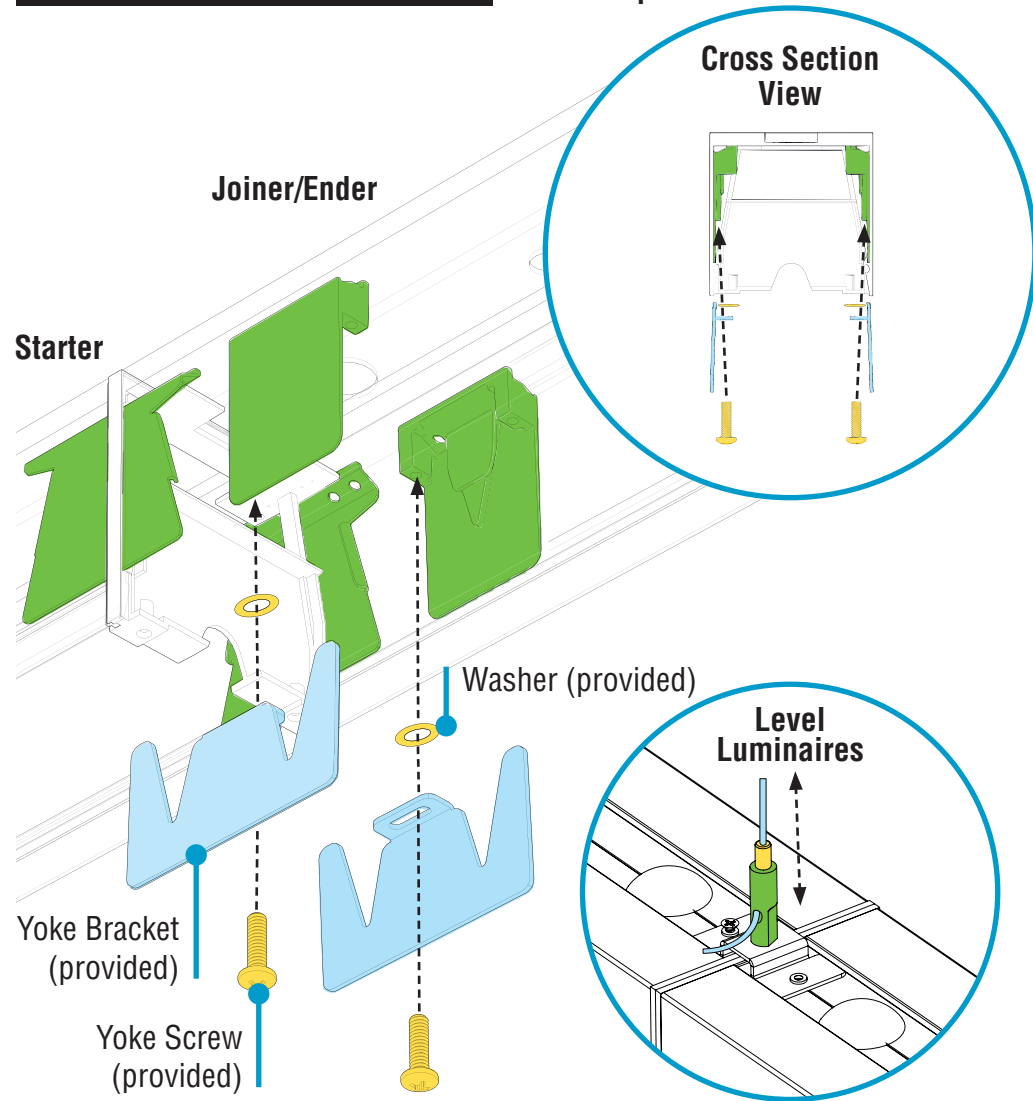

- Before installing yoke brackets, ensure the joining ends of luminaires meet flush and square.
- **CRITICAL:** Ensure yoke brackets properly engage with aligner sleeves.
- Secure joint by threading (but not yet tightening) yoke screws through yoke brackets and washers and into the aligner sleeves.
- Level each luminaire to desired height by depressing top of grippers to adjust cable lengths.
- **NOTE:** Ensure luminaires are level and meet flush and square before fully tightening yoke screws.
- Tighten yoke screws¹ until joint seam of luminaires is closed.

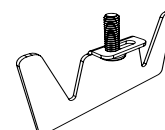
 Yoke Bracket w/ Screw and Washer
#10-32 x 5/8" (provided)

¹ Screwdriver with 6" bit required.

IN ALIGNMENT

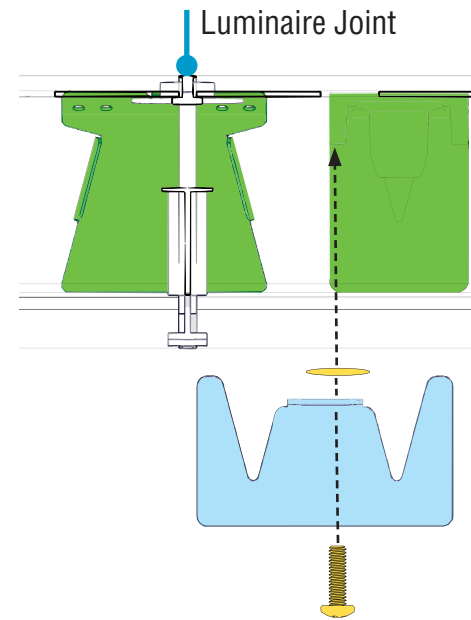

CORRECTLY INSTALLED

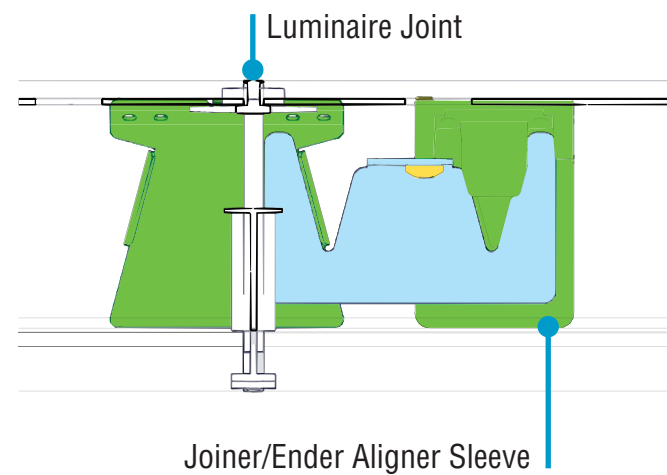

B. Make Electrical Connections Bottom-Up View

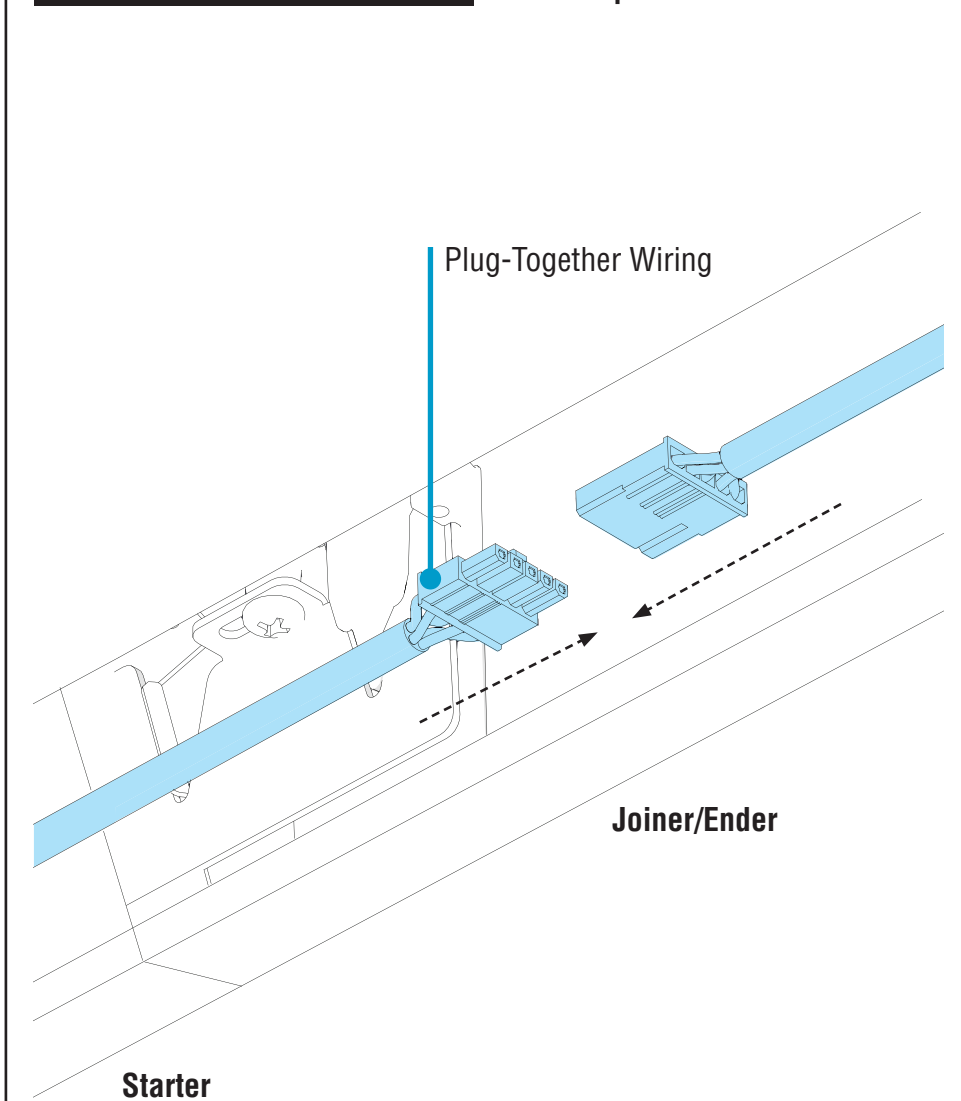

- Connect plug-together wiring.



Universal &
Robust Joints



Simple
Plug-Together
Wiring

HP-4 Wet Location Direct Installation Instruction

Step 7 - Closing Luminaires

A. Crimp Cables Top-Down View

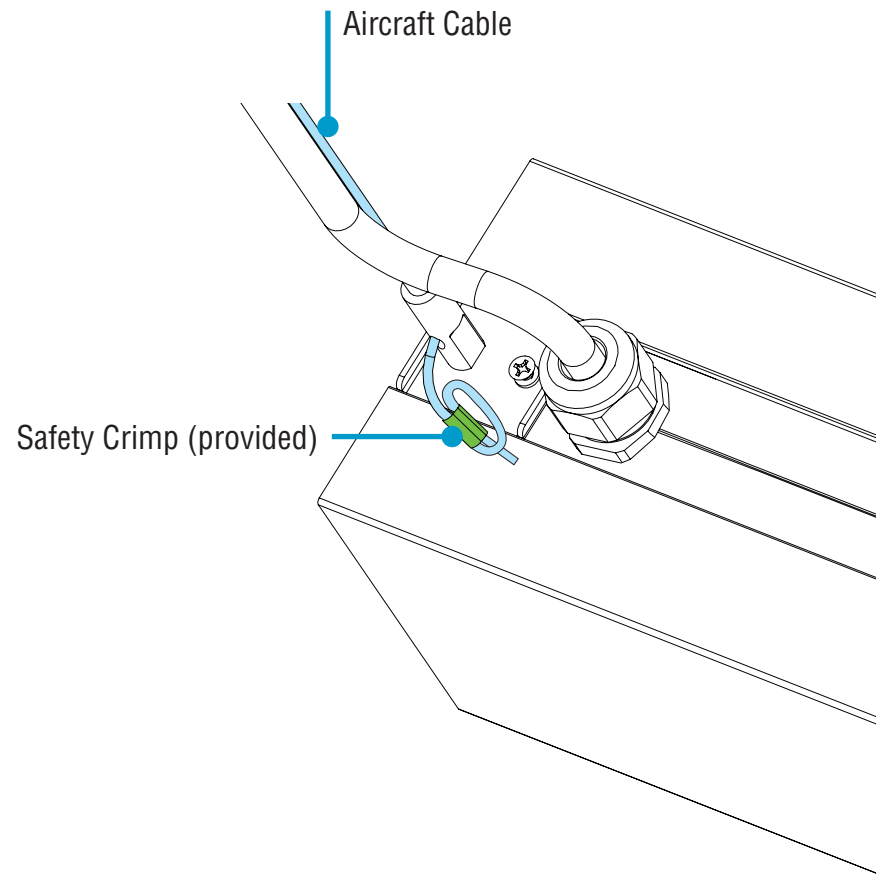

- Ensure all leveling has been performed prior to applying safety crimp.
- Loop aircraft cable through safety crimp.
- Crimp, then cut excess cable.

B. Final Step - Replace Backplates, Diffusers, & Covers Bottom-Up View

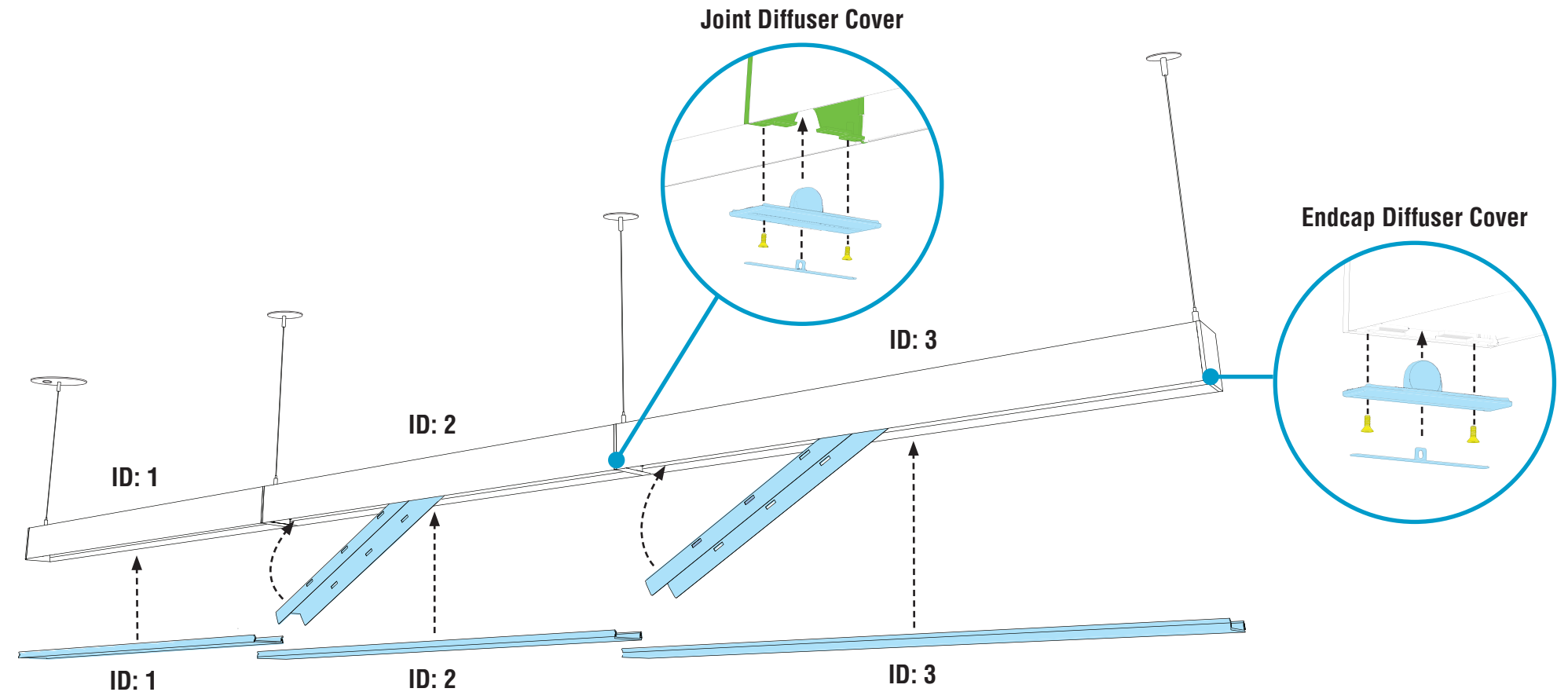

- **NOTE:** If your installation includes a battery backup, please see addendum (98333) that should be included with your kitting package.
- Reinstall any open backplates by rotating into luminaire body and snapping back into clips.
- Remove diffusers from protective plastic bag.
- **CAUTION:** Wear gloves to keep diffuser surface clean, take care to wipe off any water or condensation on diffusers before installing into luminaire.
- **CRITICAL:** Be sure to install correct diffuser to its corresponding luminaire ID.
- Install diffusers into luminaire body, ensuring they snap into place.
- Reinstall all endcap and joint diffuser covers.
- Turn power on to luminaire.

