

Submitted by:		Date:
Type:	Project:	
Ordering Info:		

High Performance Perimeter Slot (HP-WS)



The High Performance Perimeter Slot (HP-WS) creates a wash of ambient and vertical illumination at the transition between the wall and the ceiling plane. Available in 2', 3', 4', & 8' sections with telescoping options that can be combined to make longer runs, and 2", 4", and 6" regressed optic options.

This Product is enrolled in the International Living Future Institute (ILFI) Declare 2.0 Program and is third-party verified with options achieving **Red List Approved** and **Red List Declared** status.

CROSS SECTIONS

Distribution is attained with mid-power LEDs distributed evenly and paired with a precise regressed diffuser.

See page 6 for more options

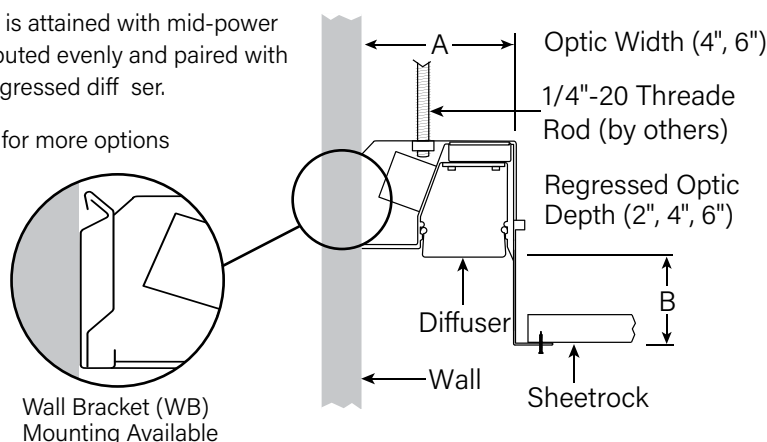

FEATURES

POST-CEILING THREADED-ROD (TR) MOUNTING INSTALLATION

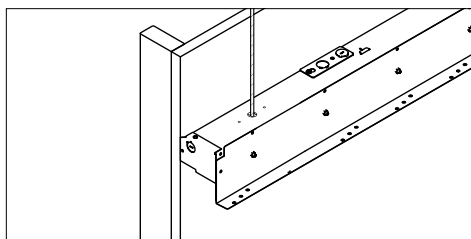

Allows a luminaire to be installed after ceiling framing is complete.

FULLY ILLUMINATED 90° CORNERS

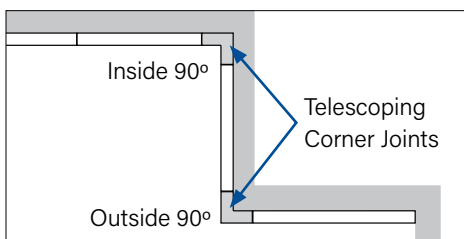

Fully illuminated 90° corners with telescoping standard. Refer to page 3 for telescoping lengths on inside and outside corners.

STRAIGHT RUNS WITH OPTIONAL TELESCOPING

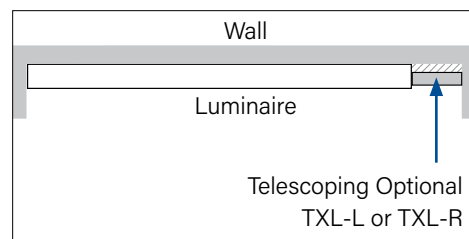

Optional telescoping section adds up to 12 inches for a straight run. Telescope section mounts securely to wall.



Declare.



Submitted by:		Date:
Type:	Project:	
Ordering Info:		

High Performance Perimeter Slot (HP-WS)

Ordering Guide Example: HP - WS - 4W - 2D - 36' - S - 835 - SW - 120 - SC - FC-10% - TR - C1 - FE-L - FE-R - SW - LGD18W - REE - RLD

BODY TYPE

OUTPUT and LED TYPE

Platform	Series Name	Optic Width	Regressed Optic Depth	Total Length of Run	Light Output
HP - High Performance	WS - Perimeter Slot	4W - 4" Width 6W - 6" Width	2D - 2" Depth 4D - 4" Depth 6D - 6" Depth	2', 3', 4', 8', multiples standard. Telescoping available for fractional lengths	S - Standard (317 lm/ft) B - Boosted (399 lm/ft) H - High (602 lm/ft) V - Very High (774 lm/ft)

* Specify Tailored lm/ft of outputs between Standard (S) and Very High (V). Consult factory for tailored lumen output outside of this range.

OUTPUT and LED TYPE

MECHANICAL/OPTICAL OPTIONS

ELECTRICAL OPTIONS

LED CRI/CCT	Reflector System	Voltage	Circuiting
830 - 80 CRI, 3000K 835 - 80 CRI, 3500K 840 - 80 CRI, 4000K 930 - 90 CRI, 3000K 935 - 90 CRI, 3500K 940 - 90 CRI, 4000K 8TW - 80 CRI, Tunable White 9TW - 90 CRI, Tunable White	SW - Signal White	120 - 120 Voltage 277 - 277 Voltage 347 - 347 Voltage	SC - Single Circuit * One single circuit in a run MC - Multi-Circuit * More than one switch leg or zone. Must provide circuiting requirements for each luminaire to manufacture. Factory shop drawings required.

* Battery, Night Light, and Emergency to Generator circuits are in addition to the normal luminaire circuit(s)

ELECTRICAL OPTIONS

MOUNTING OPTIONS

Driver Selection	Mounting Method	Ceiling Hardware Type*
0-10V Driver Options FC-10% - 0-10V 10% (standard) FC-1% - 0-10V 1% OTi-10% - EldoLED OTi, 0-10V 10% ¹ OTi-1% - EldoLED OTi, 0-10V 1% ¹ ELD-10V-0% - EldoLED SOLOdrive, 0-10V 0.1% 10V-TW-10% - EldoLED OTi, 0-10V 10% (Tunable White) ¹ DALI Driver Options FC-DALI-1% - DALI 1% DXL-DALI-1% - EldoLED Dexal, 1% ELD-DALI-0% - EldoLED SOLOdrive, 0.1% ELD-DALI-TW - EldoLED DUALdrive LightShape, 0.1% (Tunable White)	TR - Threaded Rod ³ WB - Wall Bracket ⁴	C1 - 15/16" T-Bar C2 - 9/16" T-Bar C3 - Screw Slot SF - Spackle Flange C1T - 15/16" Tegular C2T - 9/16" Tegular * Compatible with all T-Bar type. T-Bar width provided is 15/16" wide.

See Page 3 for additional driver options and details

NOTE: These mounting hardware will be difficult to change on the field.

OTHER OPTIONS

End Condition Left ⁵	End Condition Right ⁵	Finish	Emergency Style (Optional)	Sensor (Optional)	Special Options (Optional)
FE-L - Flat Endcap (standard) PE-L - Pocket Slot TXL-L - Telescoping	FE-R - Flat Endcap (standard) PE-R - Pocket Slot TXL-R - Telescoping	SW - Signal White (standard)	LGD18W - Legrand 18W Brand Battery Back-up LGD10W - Legrand 10W Brand Battery Back-up EM/GEN - Emergency to Generator NL - Night Light BSL310LP - Bodine Battery Back up Low Profile GTD - Generator Transfer Device ALCR - Automatic Load Control Relay	REE - Remote Enlighted ⁶ ARF-W - Lutron Athena RF ⁷ (Device Color White) ARF-B - Lutron Athena RF ⁷ (Device Color Black)	CP - Chicago Plenum ⁸ RLA - Red List Approved RLD - Red List Declared

Just one optional TXL provides a uniformly lit fixture with adjustability of up to 12". Choose TXL-L (left) or TXL-R (right)

¹ Add DTO to gain "Dim to Off" functionality (FC-10% - DTO, FC-1% - DTO)

² B & V outputs only

³ Pre- or post-ceiling

⁴ Pre-ceiling only

⁵ The end condition on each side can be specified with different hardware options to accommodate different installation features. See page 3 for more information.

⁶ Enlighted Control Unit & Sensor Cable installed for Remote mounting sensor.

⁷ 0-10V Drivers - ARF up to 40 driver may be connected. DALI Drivers - ARF up to 4 drivers can be connected

⁸ Only available with C1, C2, and C3 mounting hardware with Finelite Gridbox

Submitted by:		Date:
Type:	Project:	
Ordering Info:		

High Performance Perimeter Slot (HP-WS)

SUPPLEMENTARY DRIVER PAGE

0-10V Driver Options

FC-10%	Factory Choice, 0-10V 10% Dimming (Linear)
FC-10%-DTO	Factory Choice, 0-10V 10% Dimming, Dim-to-Off (Linear)
FC-1%	Factory Choice, 0-10V 1% Dimming (Linear)
FC-1%-DTO	Factory Choice, 0-10V 1% Dimming, Dim-to-Off (Linear)
ELD-10V-0%	EldoLED SOLOdrive, 0-10V 0.1% Dimming (Linear)
ELD-10V-1%	EldoLED ECOdrive, 0-10V 1% Dimming (Linear)
10V-TW-10%	EldoLED OTi, 0-10V 10% Dimming, <i>Tunable White</i> (Linear)
10V-TW-10%-DTO	EldoLED OTi, 0-10V 10% Dimming, Dim-to-Off, <i>Tunable White</i> (Linear)
OTi-10%	EldoLED OTi, 0-10V 10% Dimming (Linear)
OTi-10%-DTO	EldoLED OTi, 0-10V 10% Dimming, Dim-to-Off (Linear)
OTi-1%	EldoLED OTi, 0-10V 1% Dimming (Linear)
OTi-1%-DTO	EldoLED OTi, 0-10V 1% Dimming, Dim-to-Off (Linear)

DALI Driver Options

FC-DALI-1%	Factory Choice, DALI 1% Dimming (Logarithmic)
DXL-DALI-1%	EldoLED Dexal, DALI 1% Dimming (Logarithmic)
ELD-DALI-0%	EldoLED SOLOdrive, DALI 0.1% Dimming (Logarithmic)
ELD-DALI-1%	EldoLED ECOdrive, DALI 1% Dimming (Logarithmic)
ELD-DALI-TW	EldoLED DUALdrive Light Shape, DALI 0.1% Dimming, <i>Tunable White</i> (Logarithmic Dimming, Linear CCT Control)

Lutron Driver Options

LUT-ES1	Lutron, Ecosystem 1% Dimming
LUT-TW	Lutron T-Series, EcoSystem 0.1% Dimming, <i>Tunable White</i>

Submitted by:		Date:
Type:	Project:	
Ordering Info:		

High Performance Perimeter Slot (HP-WS)

SPECIFICATIONS

BODY TYPE

CONSTRUCTION: Precision cut 6063-T6 extruded aluminum visible flange. Internal joiner system, plug-together wiring standard. Steel sheet metal galvanized and powder coated body.

LENGTHS: Standard 2', 3', 4', and 8' section lengths can be combined to make longer runs. Optional telescoping sections on straight runs add a minimum of 1" up to 12" at the end of the luminaire. Contact factory for corner details and availability. Telescoping sections are available on either or both ends of the luminaire.

90° CORNERS: Illuminated 90° inside and outside corners. Standard with telescoping sections. Tapered optics is standard with inside corners.

TAPERED OPTIC: Constructed out of painted perforated metal, the Tapered Optic helps diffuse light contribution from the adjacent side to provide more uniform illumination in inside corners. Standard with 90° inside corners. Not recommended for use with outside corners.

OUTPUT AND LED TYPE

LIGHT OUTPUT: Four lumen packages available, Standard (**S**), Boosted Standard (**B**), High (**H**), and Very High (**V**). For lengths 3' and greater, the uplight and downlight can be specified with different lumen packages and dual controls. For Tailored Outputs outside of range from Standard (**S**) to Very High (**V**), consult factory. Light engines are replaceable.

MECHANICAL/OPTICAL OPTIONS

LUMEN MAINTENANCE: 90% of initial light output (L90) at 100,000+ hours; 70% of initial light output (L70) at 200,000+ hours.

REFLECTORS: Finelite Signal White powder coat finish standard.

ELECTRICAL OPTIONS

STATIC WHITE FEED: Standard with one 18-gauge/5-conductor single-circuit feed controlling uplight and downlight together (power and dimming). Specify dual feeds for independent control of uplight and downlight. 14-gauge feed used when luminaire current exceeds 5 amps.

TUNABLE WHITE FEED: Standard with one 18-gauge/5-conductor single-circuit feed. 14-gauge feed used when fixture current exceeds 5 amps.

STATIC WHITE DRIVER: Replaceable 120V, 277V, and 347V constant current reduction dimming driver standard. Can be wired dimming or non-dimming. 0-10V dimming controls with a range of 100%-10% standard. Dimming to 1% available. Separate dimming for uplight and downlight available. Driver is fully accessible from below the ceiling.

- **Power Factor:** ≥ 0.9
- **Total Harmonic Distortion (THD):** $<20\%$
- **Expected driver lifetime:** 100,000 hours

LUTRON STATIC DRIVER OPTIONS:

- **LUTES1 (LDE1)** (Hi-lume 1% EcoSystem with Soft-On, Fade-to-Black dimming (LDE1 series))

TUNABLE WHITE DRIVER: Replaceable LED driver. Driver is accessible from below the ceiling. 120V, 277V, and 347V.

- **Power factor:** ≥ 0.90
- **Total Harmonic Distortion (THD):** $<20\%$
- **Dimming Range:** 100%-10%
- **Expected driver lifetime:** 100,000 hours

LUTRON TUNABLE WHITE DRIVER OPTION: LUT-TW (0.1% T-Series 2-Channel Digital Tunable White (PSQ Series)).

MOUNTING OPTIONS

HANGING HARDWARE: The standard mounting (Threaded Rod - TR) option eliminates the need to install luminaires prior to the slot being framed. Luminaire mounts on threaded rods. Gasket runs length of luminaire ensuring a clean finish at the wall. Optional mounting includes a wall bracket that is attached to the wall. Luminaires are then snapped onto the bracket. Luminaire installation that uses the mounting bracket must be performed before the perimeter slot framing is built.

TUNABLE WHITE HANGING HARDWARE: For grid ceiling applications the dual GridBox™ mounting is supplied (standard). For hard ceiling applications the ceiling mounting box is supplied (standard).

TUNABLE WHITE INTERCONNECTION CABLES: Luminaires are pre-wired with plug-and-play interconnection cables to support easy plug-together joining of fixture runs.

OTHER OPTIONS

ENDCAPS: The luminaire can terminate in three different end conditions to accommodate project needs. Endcaps are made of 20-gauge die-formed powder-coated steel. Flat (standard) Endcap adds 1/8", Pocket Slot Endcap adds 1-1/4", and for Telescoping Endcap refer to telescoping section below.]

END CONDITIONS:

FLAT (standard) (FE-L or FE-R): Is used when the luminaire terminates at a wall. Adds 1/8" per endcap to overall length of the luminaire.

POCKET SLOT (PE-L or PE-R): Includes the necessary hardware to accommodate ceiling materials when the luminaire doesn't terminate at a wall. Adds 1-1/4" for Spackle Flange and 1" for T-Bar per endcap to overall length of the luminaire.

Continued

Page 4

Submitted by:		Date:
Type:	Project:	
Ordering Info:		

High Performance Perimeter Slot (HP-WS)

SPECIFICATIONS

TELESCOPING (TXL-L or TXL-R): Provides up to 12" of additional illuminated section to accommodate variances in the built-in wall slot. Telescoping available on both ends of 4' and 8' luminaire sections. Adds a minimum of 1" per end to overall section length. Telescoping only available at one end of 2' and 3' luminaire sections. Adds a minimum of 2" to overall length of 2' sections and a minimum of 1" to overall length of 3' sections. Telescoping is standard with corners. Telescoping section must end at wall and be secured with bracket (provided). Just **one** optional TXL provides a uniformly lit fixture with adjustability of up to 12".

Choose TXL-L (**left**) or TXL-R (**right**)

EMERGENCY STYLE: Optional emergency to generator/inverter wiring, internal generator transfer switch, nightlight wiring, backup battery. Factory-choice low-profile backup battery available. Chicago Plenum Option available (includes telescoping luminaries), 8' minimum luminaire length for low profile battery pack. Backup batteries deliver 1519 lumens. Half of a 4' section will be illuminated in emergency mode. Optional fusing is available.

Tunable White ELECTRICAL OPTIONS[®]:

- **TW Driver Options 0-10V:** EM/GEN, GTD or Battery Back up
- **DALI:** EM/GEN, GTD or Battery Back up
- **LUTRON:** EM/GEN, GTD or Battery Back up

FINISHES: Finelite Signal White powder coat finish standard. Optional adder: 179 colors available using RAL color chart. Custom color applies to the visible T-Bar flange.

LABELS: Luminaire and electrical components are ETL-listed conforming to UL 1598 in the U.S.A. and CAN/CSA C22.2 No. 250.0 in Canada. In accordance with NEC Code 410.130 (G), this luminaire contains an internal driver disconnect. UL 924 and UL 2108 - PoE options available on request. IC-Rated. Damp Location. These fixtures are rated for Damp Location. Finelite products use electronic components that are RoHS compliant, and the mechanical components of the luminaire have been verified to not knowingly contain any restricted substances listed per RoHS Directive 2015/863. Consult factory for tailored lighting options. Finelite makes the specification process easy when putting healthier products on your projects. Simply add – **RLA** (Red List Approved) or – **RLD** (Red List Declared) to your part number.

WEIGHT: 5.6 lb/ft

WARRANTY: 10-year performance-based warranty on all standard components. Optional accessories such as emergency battery packs are covered by their individual manufacturer warranties.

Submitted by:		Date:
Type:	Project:	
Ordering Info:		

High Performance Perimeter Slot (HP-WS)

THREADED-ROD (TR) MOUNTING LOCATION

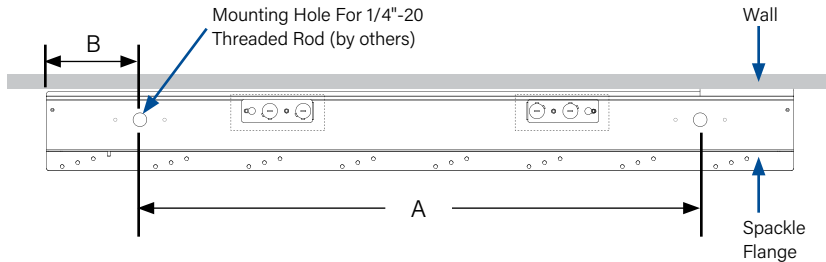

MOUNTING HOLE LOCATION TABLE		
LUMINAIRE LENGTH	A (in)	B (in)
2'	18	3
3'	30	3
4'	36	6
8'	84	6

THREADED-ROD (TR) MOUNTING CROSS SECTIONS

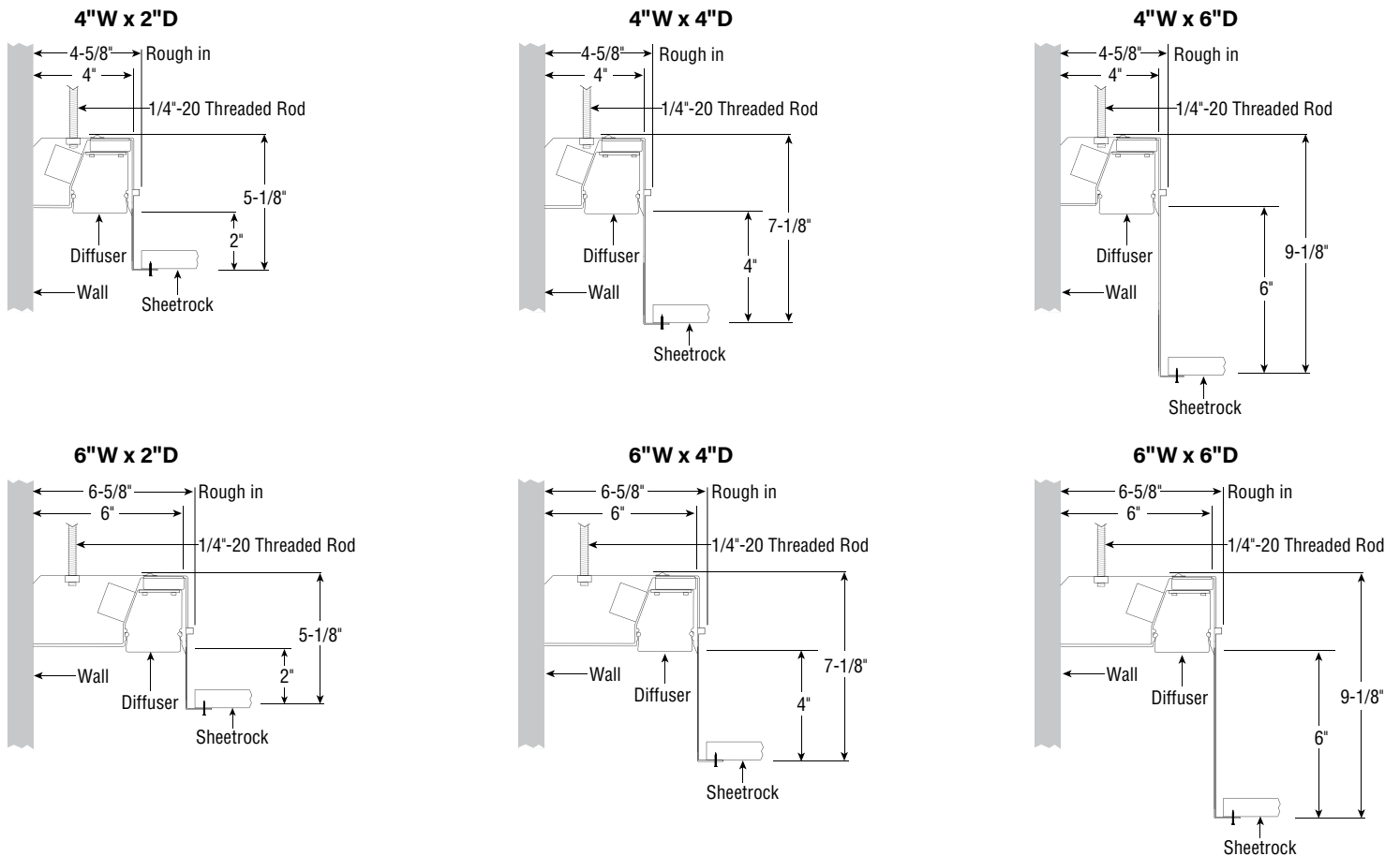

CEILING TYPES — THREADED-ROD (TR) MOUNTING

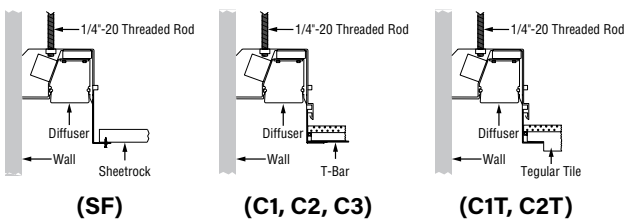

WALL BRACKET (WB) MOUNTING

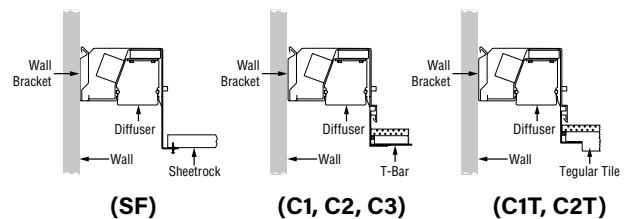

Submitted by:		Date:
Type:	Project:	
Ordering Info:		

High Performance Perimeter Slot (HP-WS)

RUN LENGTHS

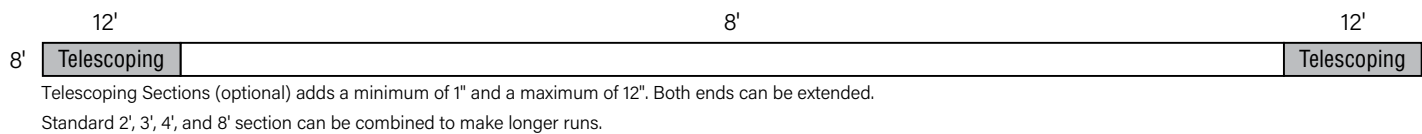
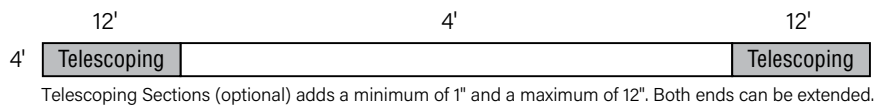
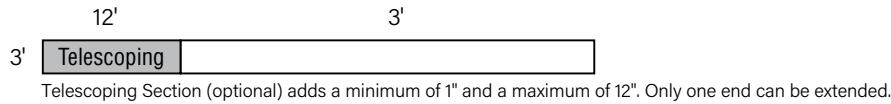
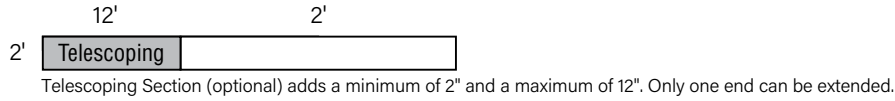

Endcaps Information

The **Flat Endcap** adds 1/8" per endcap to the section length.

The **Pocket Slot Endcap** adds 1-1/4" for Spackle Flange and 1" for T-Bar per endcap to the section length.

The **Telescoping Endcap** adds:

- A minimum of 2" to a 2' section
- A minimum of 1" to a 3' section
- A minimum of 1" to 4' and 8' sections

90° INSIDE AND OUTSIDE FULLY ILLUMINATED CORNER MEASURING DETAILS

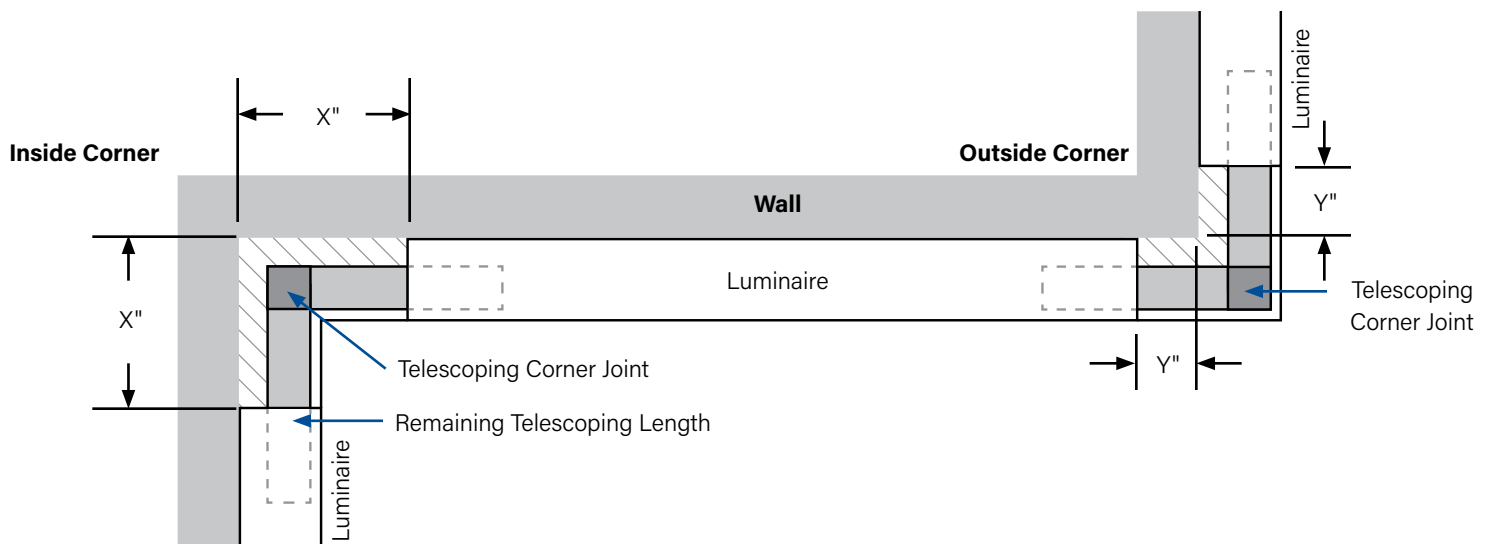

Luminaire Width Configuration	Measurement From End of Luminaire to Wall			
	Inside Corner		Outside Corner	
	X" Min	X" Max	Y" Min	Y" Max
4W	8"	14"	1"	8"
6W	10"	16"	1"	7"

Notes

- Inside and outside corners ship standard with telescoping.
- Telescoping is optional for straight runs.

Submitted by:		Date:
Type:	Project:	
Ordering Info:		

High Performance Perimeter Slot (HP-WS)

FEED OPTIONS

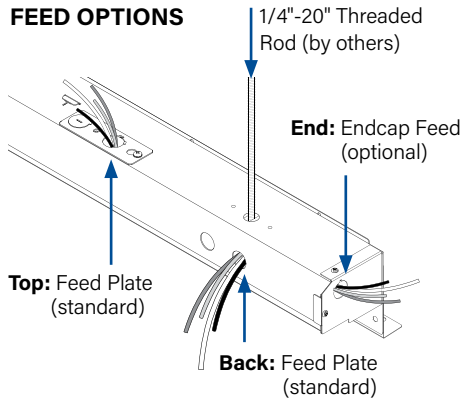

TELESCOPING (TXL-L or TXL-R)

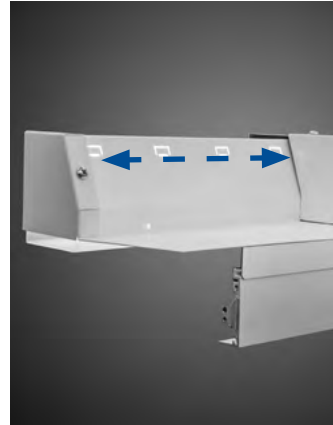

TAPERED OPTIC STANDARD WITH 90° INSIDE CORNERS

helps diffuse light contribution evenly in inside corners

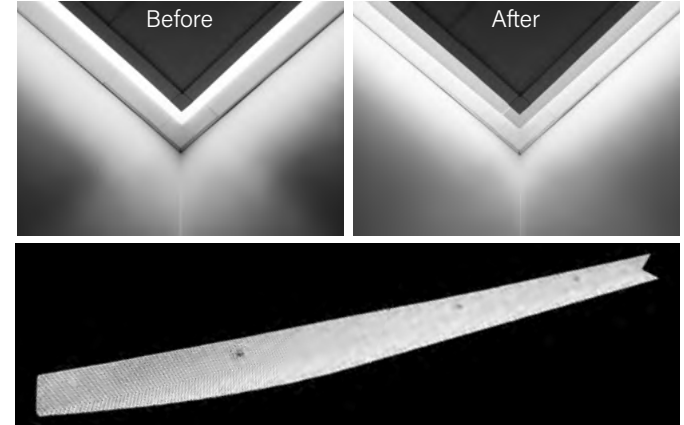

Refer to installation instructions for feed hole measurements.

ENDCAP OPTIONS

STANDARD FLAT (FE-L or FE-R)

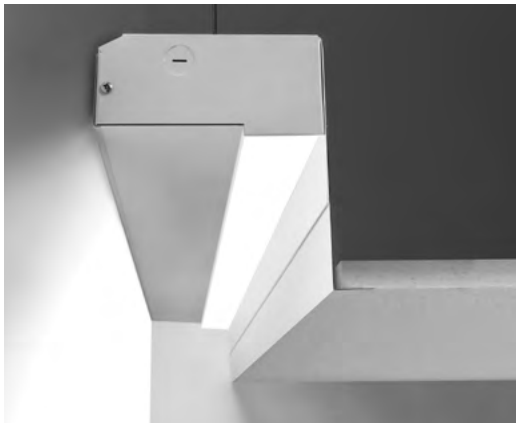

Adds 1/8" per endcap to the section length. Spackle Flange version shown, T-Bar available.

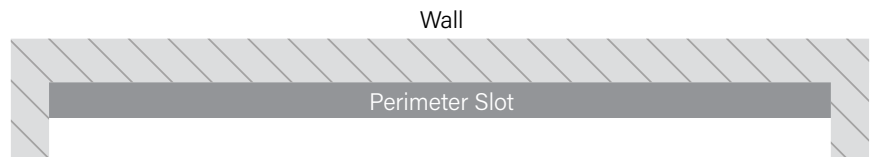

Flat end condition for when luminaire terminates at a vertical surface such as a wall.

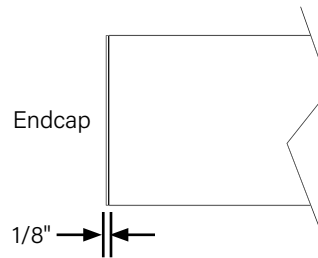

POCKET SLOT (PE-L or PE-R)



Adds 1-1/4" for Spackle Flange and 1" for T-Bar (includes endcap dimension 1/8") per endcap to the housing length on shop drawings. T-Bar version shown, Spackle Flange available.

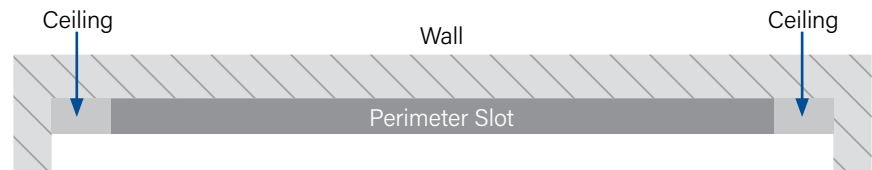

Pocket slot end condition for when slot terminates before meeting additional vertical wall surface.

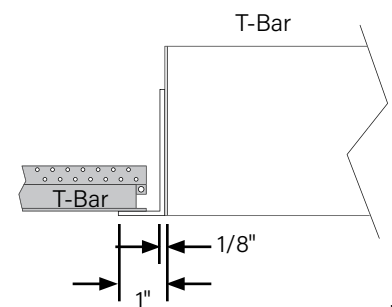
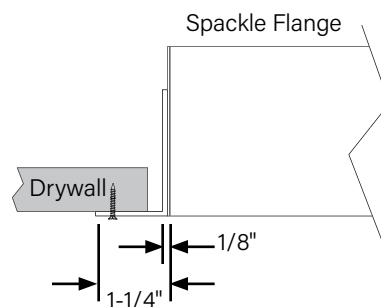

Submitted by:		Date:
Type:	Project:	
Ordering Info:		

High Performance Perimeter Slot (HP-WS)

Photometry - 4' Luminaire 3500K

4"W x 2"D

Very High Output - 120V

Efficacy: 84 lumens per watt

Total luminaire output: 3097 lumens (774 lm/ft)
37 watts (9.3 W/ft)

Peak Candela Value: 1333 @ 15°

CRI: 80 / CCT: 3500K

ITL LM79 Report 86712

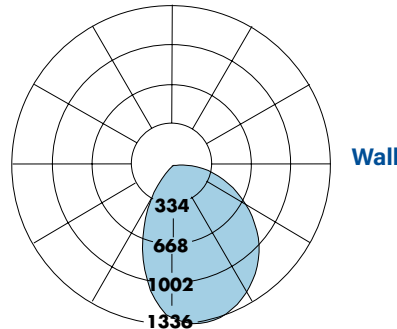

		CandELA distribution					
		0.0	45	90	135	180	Flux
0	1235	1235	1235	1235	1235	1235	
5	1280	1264	1229	1198	1168	116	116
15	1333	1280	1172	1002	903	321	321
25	1323	1241	1060	746	586	460	460
35	1258	1150	909	489	297	519	519
45	1144	1020	735	248	60	502	502
55	967	859	555	49	2	436	436
65	741	654	375	3	0	344	344
75	514	437	204	2	0	233	233
85	295	232	52	1	0		

Total Light Output, 3500K, 80 CRI (Lumens) - 4' Luminaire

	S ¹	B ¹	H ¹	V ²
4"W x 2"D	1268	1594	2409	3097

Light Output, 3500K, 80 CRI (Lumens Per Foot)

	S ¹	B ¹	H ¹	V ²
4"W x 2"D	317	398	602	774

Power, 3500K, 80 CRI (Watts Per Foot)

	S ¹	B ¹	H ¹	V ²
4"W x 2"D	3.6	4.6	7.1	9.3

Efficacy, 3500K, 80 CRI (Lumens Per Watt)

	S ¹	B ¹	H ¹	V ²
4"W x 2"D	88	87	85	84

Sample Lumen Adjustment Calculation

Lumen Adjustment Factors 80 CRI

3000K	0.985
3500K	1.000
4000K	1.032

Lumen Adjustment Factors 90 CRI

3000K	0.746
3500K	0.760
4000K	0.789

High Output (H) 4000K, 90 CRI

Lumen Adjustment Factor: 0.789

Total Light Output: 2409 lm x 0.789 = 1901 lm

Total Light Output per Foot: 602 lm/ft x 0.789 = 475 lm/ft.

watts/foot: 7.1 W/ft.

$$\text{Efficacy} = \frac{475 \frac{\text{lm}}{\text{ft.}}}{7.1 \frac{\text{W}}{\text{ft.}}} = 67 \text{ lm/W}$$

Notes

– Refer to LM-79 reports for other configurations.

Wattage is Real Power. If you would like additional details to calculate Apparent Power, please contact your local Finelite representative.

S - Standard Output, B - Boosted Standard Output, H - High Output, V - Very High Output

¹ Family Correlation based on 4' luminaire 3500K Very High Output (V) test - 120V.

² Based on ITL report: 86712

Submitted by:		Date:
Type:	Project:	
Ordering Info:		

0-10V Tunable White

Finelite's award-winning, contractor friendly Tunable White luminaires are available at low cost, with powerful and simple 0-10V tuning and intensity controls.

TUNABLE WHITE FEATURES

- CCT range: 2700K - 6500K
- Dimming Range: 100% to 10%
- CRI Options: 80 CRI or 90 CRI

LUMINAIRE FAMILY MODIFICATIONS/RESTRICTIONS

HP-WS	Section Lengths			
	2'	3'	4'	8'
Output S,B,H,V Single Circuit	Rows can be comprised of 2',3',4', & 8' sections. Tailored lengths available.			
Integral Battery Backup (BSL310LP)			✓	✓

EN/GEN sections available for all body lengths

PHOTOMETRY

Apply a power adjustment factor to calculate wattage usage

POWER	CONVERSION FACTOR
	1.1X

(Example: a 50 watt luminaire in static white would draw 55 watts using 0-10V Tunable White)

WIRING DIAGRAM - DIMMABLE TO 10%

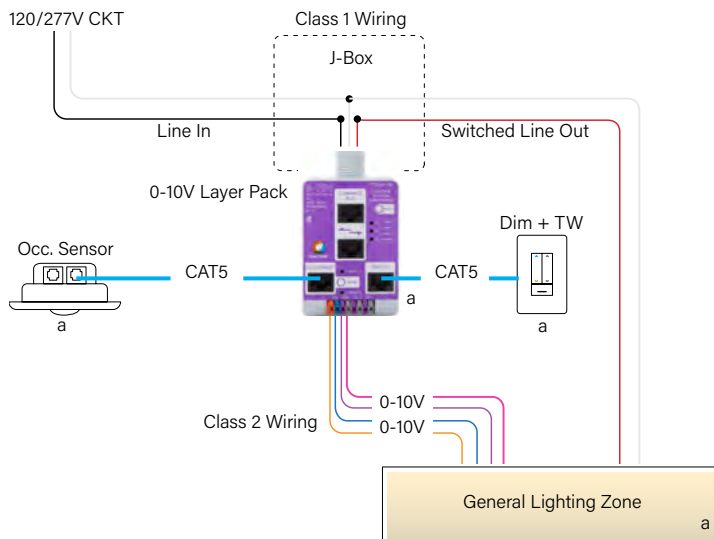

Luminaire Wiring

- **Purple (+) / Gray (-)** control wires are for intensity control
- **Orange (+) / Blue (-)** control wires are for Tunable White control

Note:

Load or Dim to Off options available.

DUAL FEED DETAIL

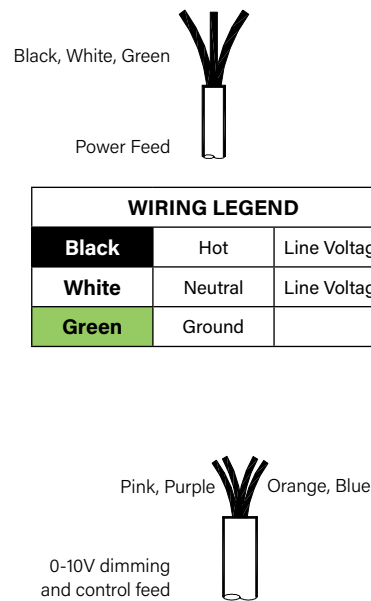

WIRING LEGEND		
Black	Hot	Line Voltage
White	Neutral	Line Voltage
Green	Ground	

WIRING LEGEND		
Pink	Dimming	0-10V DC
Purple	Dimming	0-10V DC
Orange	TW	0-10V DC
Blue	TW	0-10V DC

