

Submitted by:		Date:
Type:	Project:	
Ordering Info:		

High Performance 2" Aperture (HP-2) Surface Mount

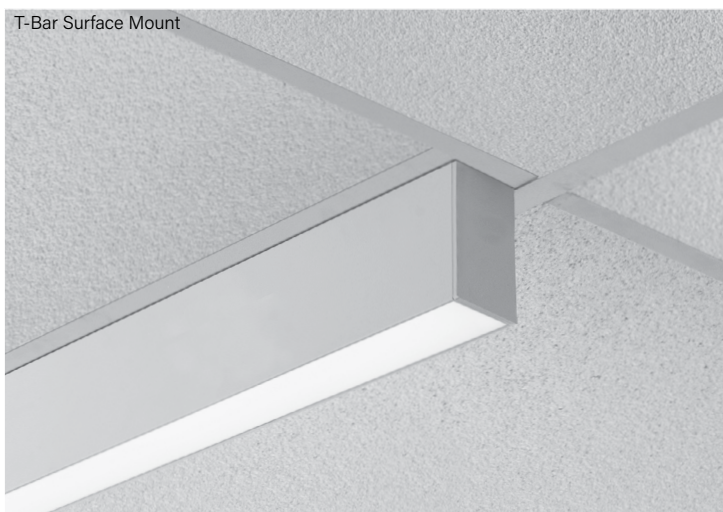

Indigo-Clean Technology is a Continuous Environmental Disinfection System that emits a narrow spectrum light that kills bacteria, Influenza-A', and SARS-CoV-2 – the virus that causes COVID-19' – and is proven effective by recently conducted independent lab testing. Unlike UV disinfection, Indigo-Clean Technology is designed to safely and continuously disinfect a space while it is fully occupied.

Single-Mode Indigo-Clean Technology utilizes a combination of blended white LEDs and 405nm LEDs on a single circuit board design. When the luminaires are on, the disinfection is active.

Dual-Mode Indigo-Clean Technology utilizes a mid-power of blended white LEDs and 405nm LEDs on a two circuit board design and full 405nm indigo light using automated controls to disinfect the space. When the space is unoccupied, it utilizes just the 405nm LEDs with increased output to increase disinfection efficacy.

These products are enrolled in the International Living Future Institute (ILFI), Declare 2.0 Program and is third-party verified with options achieving **Red List Approved** and **Red List Declared** status.

Signal White is standard finish

Note: see page 6 for all aesthetic options

CROSS SECTIONS

Surface Mount

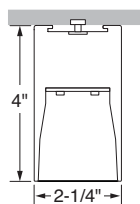

Flush Downlight Diffuser (standard)

Surface Mount Regressed

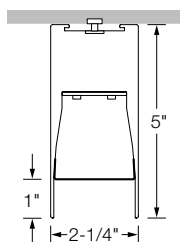

Flat Diffuser with 1" Regressed (RG)

OPTIC OPTIONS

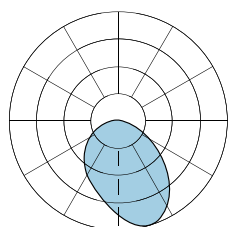

Downlight Asymmetric Optic (DAO)

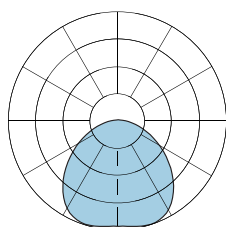

Downlight Spread Optic (DSO)

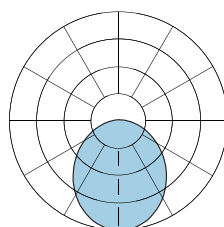

Standard Downlight Flush Optic (F)

ALSO AVAILABLE IN

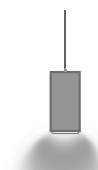

Pendant (D, ID, I)



Wall Mount (WM)



Recessed (R)



Indigo-Clean is a registered trademark of Kenall Manufacturing Co., a Legrand Company

Submitted by:		Date:
Type:	Project:	
Ordering Info:		

High Performance 2" Aperture (HP-2) Surface Mount

BODY TYPE

OUTPUT AND LED TYPE

Platform	Series Name	Luminaire Type	Luminaire Distribution	Total Length of Run	Downlight Output
HP - High Performance	2	SM - Surface Mount SM RG - Direct Regressed ^{1,2}	D - Direct	Minimum 2' section length. Increments accurate to 1/16" (±1/32"), standard. 12' maximum section length.	H - High (606 lm/ft) V - Very High (780 lm/ft) TL - Tailored: _____ lm/ft*

* Specify lm/ft of outputs between High (H) and Very High (V). Consult factory for tailored lumen output outside of this range.

OUTPUT AND LED TYPE

MECHANICAL/OPTICAL OPTIONS

ELECTRICAL OPTIONS

LED CRI/CCT	Downlight	Reflector System	Voltage	Circuiting ²
832-SMIC - 80 CRI, 3200K Single Mode Indigo-Clean	F - Flush (standard)	96LG - 96 Low Gloss White	120 - 120 Voltage	SC - Single Circuit* One single circuit in a run
837-SMIC - 80 CRI, 3700K Single Mode Indigo-Clean	BG - Bottom Glow		277 - 277 Voltage	MC - Multi-Circuit* More than one switch leg or zone. Factory shop drawings required
843-SMIC - 80 CRI, 4300K Single Mode Indigo-Clean	DL - 1" Drop Down Lens		347 - 347 Voltage	
832-DMIC - 80 CRI, 3200K Dual Mode Indigo-Clean	RG-D - Flat Diffuser with 1" Regress ¹			
837-DMIC - 80 CRI, 3700K Dual Mode Indigo-Clean	RG-WCB - White Cross Blade Baffle ¹			
843-DMIC - 80 CRI, 4300K Dual Mode Indigo-Clean	RG-LHE - Hollowed Ellipse Louver ¹			
	RG-LHC - Hex Louver ¹			
	DAO-L - Downlight Asymmetric Optic Left ⁴			
	DAO-R - Downlight Asymmetric Optic Right ⁴			
	DSO - Downlight Spread Optic ⁴			

* Battery, Night Light, and Emergency to Generator circuits are in addition to the normal luminaire circuit(s)

ELECTRICAL OPTIONS

MOUNTING OPTIONS

OTHER OPTIONS

Driver Selection	Ceiling Hardware Type	Endcap Style	Finish
0-10V Driver Options FC-10% - 0-10V 10% (standard) FC-1% - 0-10V 1% OTi-10% - EldoLED OTi, 0-10V 10% ³ OTi-1% - EldoLED OTi, 0-10V 1% ³ ELD-10V-0% - EldoLED SOLOdrive, 0-10V 0.1%	C1 - 15/16" T-Bar C2 - 9/16" T-Bar C3 - Screw Slot C4 - Hard Ceiling	FE - Flat Endcap (standard) DE - 1" Drop Endcap ⁵ OE - Open Endcap ⁶	SW - Signal White (standard) FB - Finelite Black SA - Satin Aluminum #### - RAL Color Code ⁷
DALI Driver Options FC-DALI-1% - DALI 1% DXL-DALI-1% - EldoLED Dexas, 1% ELD-DALI-0% - EldoLED SOLOdrive, 0.1%	DMX Driver Options ELD-DMX - EldoLED POWERdrive, 0.1% Lutron Driver Options LUT-ES1 - Lutron, Ecosystem 1%		

See Page 3 for additional driver options and details

OTHER OPTIONS

Emergency Style (Optional) <small>See page 5 Backup Battery table</small>	Integrated Sensor (Optional) ⁸	Special Options (Optional)
LGD18W - Legrand 18W Brand Battery Back-up LGD10W - Legrand 10W Brand Battery Back-up EM/GN - Emergency to Generator NL - Night Light BSL310LP - Bodine Battery Back up Low Profile GTD - Generator Transfer Device ALCR - Automatic Load Control Relay	OBO - Occupancy OBD - Daylight W601 - Wattstopper ⁹ Wireless Sensor OBE - Enlighted ¹⁰ REE - Remote Enlighted ¹¹ CLM - Encelium Sensor RE7 - nLight Air Sensor Integrated Sensor not available for Dual-Mode	AOCC-W - Lutron Athena Sensor (Device Color White) ¹² AOCC-B - Lutron Athena Sensor (Device Color Black) ¹² ARF-W - Lutron Athena RF (Device Color White) ¹² ARF-B - Lutron Athena RF (Device Color Black) ¹² VOCC - Lutron Vive Sensor ¹³ VRF - Lutron Vive RF ¹³ CP - Chicago Plenum ¹⁴ RLA - Red List Approved RLD - Red List Declared

¹ Regressed only

² Contact factory for switching options

³ Add DTO to gain "Dim to Off" functionality (FC-10% - DTO, FC-1% - DO). Not available with Dual-Mode.

⁴ Not available with Regressed

⁵ 1" Drop Down Lens downlight only

⁶ Available with Hollowed Ellipse Louver (LHE) only

⁷ 20 business days lead time for color

⁸ Minimum fixture length with a sensor is 3ft.

⁹ LMFS-601 w/ 0-10V driver(s) and LMFI-111, up to 6 drivers may be connected. LMFS-601 w/ Dali driver, only 1 driver can be connected.

¹⁰ Enlighted components installed by Finelite, provided by others

¹¹ Enlighted Control Unit & Sensor Cable installed for Remote mounting sensor.

¹² 0-10V Drivers - **AOCC** up to 10 drivers may be connected; **ARF** up to 40 drivers may be connected

DALI Drivers - **AOCC & ARF** up to 4 drivers can be connected.

¹³ Lutron Vive Ingrated Sensors require a DALI driver

¹⁴ Only available with C1, C2, and C3 mounting hardware with Finelite Gridbox

Submitted by:		Date:
Type:	Project:	
Ordering Info:		

High Performance 2" Aperture (HP-2) Surface Mount

SUPPLEMENTARY DRIVER PAGE

0-10V Driver Options

FC-10%	Factory Choice, 0-10V 10% Dimming (Linear)
FC-10%-DTO	Factory Choice, 0-10V 10% Dimming, Dim-to-Off (Linear)
FC-1%	Factory Choice, 0-10V 1% Dimming (Linear)
FC-1%-DTO	Factory Choice, 0-10V 1% Dimming, Dim-to-Off (Linear)
ELD-10V-0%	EldoLED SOLOdrive, 0-10V 0.1% Dimming (Linear)
ELD-10V-1%	EldoLED ECOdrive, 0-10V 1% Dimming (Linear)
OTi-10%	EldoLED OTi, 0-10V 10% Dimming (Linear)
OTi-10%-DTO	EldoLED OTi, 0-10V 10% Dimming, Dim-to-Off (Linear)
OTi-1%	EldoLED OTi, 0-10V 1% Dimming (Linear)
OTi-1%-DTO	EldoLED OTi, 0-10V 1% Dimming, Dim-to-Off (Linear)

DALI Driver Options

FC-DALI-1%	Factory Choice, DALI 1% Dimming (Logarithmic)
DXL-DALI-1%	EldoLED Dexal, DALI 1% Dimming (Logarithmic)
ELD-DALI-0%	EldoLED SOLOdrive, DALI 0.1% Dimming (Logarithmic)
ELD-DALI-1%	EldoLED ECOdrive, DALI 1% Dimming (Logarithmic)

DMX Driver Options

ELD-DMX	EldoLED POWERdrive, DMX 0.1% Dimming (8 Bit, 1CH) (Linear)
ELD-DMX-16	EldoLED POWERdrive, DMX 0.1% Dimming (16 Bit, 2CH) (Linear)

Lutron Driver Options

LUT-ES1	Lutron, Ecosystem 1% Dimming
----------------	------------------------------

Submitted by:		Date:
Type:	Project:	
Ordering Info:		

High Performance 2" Aperture (HP-2) Surface Mount

SPECIFICATIONS

BODY TYPE

CONSTRUCTION: Precision-cut 6061-T6 extruded aluminum body. Internal joiner system and plug-together wiring are standard.

LENGTHS: Any length, 2' minimum, in increments down to 1/16th" ($\pm 1/32"$). 12' maximum section length. Hollowed Ellipse Louver (**LHE**), Hex Louver (**LHC**), and White Cross Blade Baffle (**WCB**) are available in 1' increments.

MITERED CORNERS: Illuminated corners of greater than 60° and less than 180° in a single plane, available with Flush Diffuser, Bottom Glow Diffuser, 1" Drop Down Lens, Regressed Diffuser, or White Cross Blade Baffle¹. Hollowed Ellipse Louver (**LHE**) or Hex Louver (**LHC**). Contact factory for Double miters using the White Cross Blade Baffle. Consult factory for tailored lighting options.

OUTPUT AND LED TYPE

LIGHT OUTPUT: Two lumen packages available, High (**H**), and Very High (**V**). For lengths 3' and greater, the uplight and downlight can be specified with different lumen packages and dual controls. For Tailored Outputs outside of range from High (**H**) to Very High (**V**), consult factory. Light engines are replaceable.

INDIGO-CLEAN TECHNOLOGY: Single-Mode Indigo-Clean Technology utilizes a combination of blended white LEDs, and safe 405nm LEDs to continually disinfect a space and kill bacteria, Influenza-A², and SARS-CoV-2 – the virus that causes COVID-19². Unlike UV disinfection, Indigo-Clean Technology is designed to safely and continuously disinfect a space while it is fully occupied. When the Indigo-Clean Technology light is on, disinfection is active. For optimum performance, continuously provide an average 50-60 footcandles on the work plane and high touch surfaces (24/7). Dimming generally reduces effectiveness and increases the variation in the disinfecting light's visual appearance.

Single-Mode Indigo-Clean Technology: Continuous environmental disinfection system that uses a blended white LEDs and 405nm Indigo-Clean LEDs. The narrow spectrum light provides a safe visible light that disinfects the space. When the light is on, disinfection is active.

Dual-Mode Indigo-Clean Technology: Utilizes a two circuit board design. When the space is occupied it utilizes a combination of blended white LEDs and 405nm LEDs. When the space is unoccupied, it utilizes just the 405nm LEDs with increased output to increase disinfection efficacy.

Dual-Mode Indigo-Clean Technology Controller: It is a lowvoltage internal device that determines the operational mode based on the input received from the external automated controls. An Off manual push will not turn the lights off, but rather turn the lights to Blue Mode. Please refer to Dual-Mode Application Guide for wiring diagram. Dim to Off not available.

MECHANICAL/OPTICAL OPTIONS

DOWNLIGHT OPTION: 12' maximum diffuser length. Flush frost white snap-in diffuser standard, 73% transmissive, 99% diffusion. Internal secondary diffusers at corners ensure visually seamless, uniform, continuous illumination. Available with Flush (**F**), Bottom Glow (**BG**), 1" Drop Down Lens (**DL**), White Cross Blade Baffle (**WCB**)³, Ellipse Louver (**LHE**)³, Hex Louver (**LHC**)³, Downlight Asymmetric Optic (**DAO**)⁴, Downlight Spread Optic (**DSO**)⁴, and Regressed downlight diffusers (**RG**). 1" Drop Down Lens made of highly efficient acrylic. Available with a solid endcap or an endcap with a diffuse filler to continue the luminous aesthetic. Downlight Spread Optic is an extruded lens with a subtle ribbed appearance providing a batwing distribution for improved optical performance. Consult factory for more tailored lumen outputs.

LUMEN MAINTENANCE: White LEDs: 90% of initial light output (L90) at 100,000+ hours; 70% of initial light output (L70) at 200,000+ hours. 405nm LEDs: 70% of initial output at L70 @ 60,000 hours.

REFLECTORS: Die-formed 20-gauge cold-rolled steel reflectors finished in 96LG High Reflectance white powder coat paint.

ELECTRICAL OPTIONS

STATIC WHITE FEED: Standard with one 18-gauge/5-conductor single-circuit feed controlling uplight and downlight together (power and dimming). Specify dual feeds for independent control of uplight and downlight. 14-gauge feed used when luminaire current exceeds 5 amps.

STATIC WHITE DRIVER: Replaceable 120V, 277V, and 347V Constant Current Reduction dimming driver standard. Can be wired dimming or non-dimming. 0-10V dimming controls with a range of 10%- 100% standard. Dimming to 1% available. Separate dimming for uplight and downlight available. Driver is fully accessible from below the ceiling.

- **Power Factor:** ≥ 0.9
- **Total Harmonic Distortion (THD):** <20%
- **Expected driver lifetime:** 100,000 hours

LUTRON DRIVER OPTIONS:

- **LUT-ES1 (LDE1)** - (Hi-Lume 1% EcoSystem with Soft-On, Fade-to- Black dimming (LDE1 series))

MOUNTING OPTIONS

HANGING HARDWARE: Lay-in ceiling types: caddy clip with 1/4" - 20 stud and nut. Drywall or concrete surfaces (walls or ceilings): 1/4" - 20 stud and nut (provided by others). Mounted with three equidistant suspension points.

¹ White Cross Blade (WCB) baffles not available with custom angles. Available in 90 degrees only

² [Indigo-Clean Research Reports](#)

³ Regressed only

⁴ Not available with Regressed

Protected by one or more US Patents: 8915613; D702,391; D702,390; D700,732

Submitted by:		Date:
Type:	Project:	
Ordering Info:		

High Performance 2" Aperture (HP-2) Surface Mount

SPECIFICATIONS

OTHER FEATURES

ENDCAPS: Flat diecast aluminum endcaps (**FE**) add 1/4" to each end of luminaire. 1" Drop Down Lens Endcap (**DE**) includes diffuse element to continue luminance of drop lens. Open Endcap (**OE**) is for use with the Hollowed Ellipse Louver (**LHE**)²; following the curve of the louver.

EMERGENCY STYLE: Optional emergency to generator/inverter wiring, internal generator transfer switch, nightlight wiring, step-dimming driver, backup battery.

Backup Battery		
	Legrand 18W	Legrand 10W / Bodine BSL310LP
HP2-SM-D		
Min. Housing Length	8'	4'*
EM Lumen Output	1560	929
EM Section Illuminated	2'	2' or 4'

Based on 3700K and 80-CRI

* Minimum fixture housing length for battery pack approved without sensor

** Exception: 5' not available, 6'+ okay.

Bodine GTD and Legrand ALCR Min. Length	
Configuration	Min Length
Generator	4'
Generator + OCC	6'
Day	4'
Generator + Day	6'

INTEGRATED SENSORS: Integrated PIR (Passive Infrared) Occupancy (**OBO**) or Daylight Sensors (**OBD**) available with Flush and Bottom Glow downlight diffusers. PIR sensors not recommended for stairwell applications. Refer to Occupancy Sensor

& Daylight Sensor tech sheet and the Embedded Intelligence landing page for more information and additional sensor options. Minimum fixture length with a sensor is 3ft.

PATENT: Indigo-Clean products and technology covered by U.S. Patent No.US 9,039,966 and US 8,398,264. Product may also be covered by patents found at www.kenall.com/patents.

FINISHES: Finelite Signal White (**SW**) powder coat, Finelite Black (RAL 9005) with semi gloss fine texture (**FB**), and Satin Aluminum (**SA**) are standard. Optional Adder: 179 RAL colors⁵ are available.

LABELS: Luminaire and electrical components are ETL-listed conforming to UL 1598 in the U.S.A. and CAN/CSA C22.2 No. 250.0 in Canada. In accordance with NEC Code 410.130 (G), this luminaire contains an internal driver disconnect. UL 924 and UL 2108 - PoE options available on request. EPA Est.No. 99530-CA-1, -2, -3. These fixtures are rated for Damp Location. IC Rated. Finelite products use electronic components that are RoHS compliant, and the mechanical components of the luminaire have been verified to not knowingly contain any restricted substances listed per RoHS Directive 2015/863. Consult factory for tailored lighting options. Finelite makes the specification process easy when putting healthier products on your projects. Simply add - **RLA** (Red List Approved) or - **RLD** (Red List Declared) to your part number.

WEIGHT⁶: SM - 2.3 lb/ft; WW - 2.9 lb/ft

WARRANTY: 5-year performance-based warranty on all standard components. Optional accessories such as emergency battery packs are covered by their individual manufacturer warranties.

SURFACE MOUNT OPTIONS



Ceiling Surface Mount



Horizontal Surface Mount

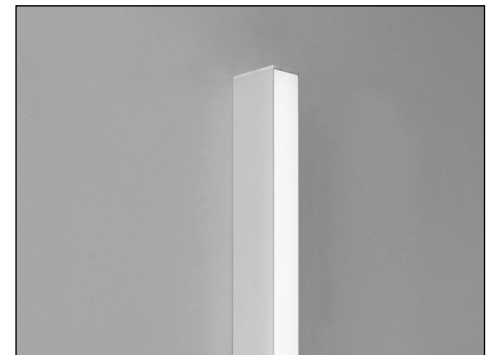

Vertical Surface Mount

⁵ 20 business days lead time for color

⁶ Excludes Battery Back up and Generator Transfer Device weight

Submitted by:		Date:
Type:	Project:	
Ordering Info:		

High Performance 2" Aperture (HP-2) Surface Mount

AESTHETIC OPTIONS

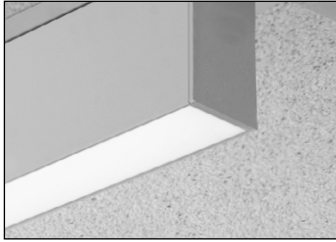

Flush Diffuser (F)

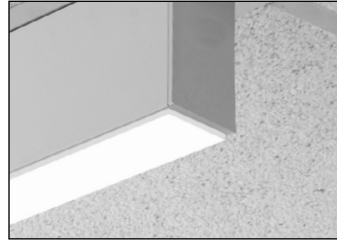

Bottom Glow Diffuser (BG)

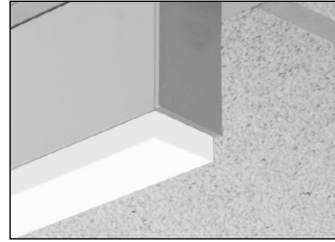

1" Drop Down Lens (DL)

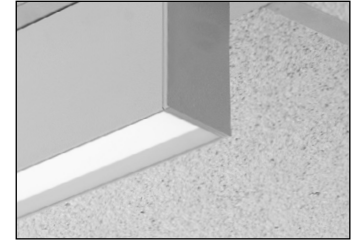

Flat Diffuser with 1" Regressed (RG-D)



Downlight Asymmetric Optic (DAO)¹
Externally flush



Downlight Spread Optic (DSO)¹
Externally flush

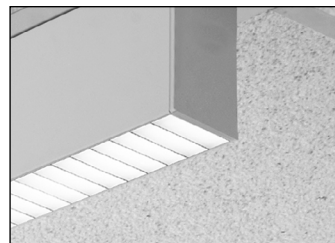

White Cross Blade Baffle² (RG-WCB)



Hex Louver² (RG-LHC)

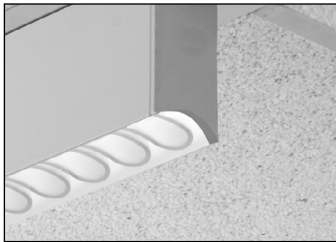

Hollowed Ellipse Louver² (RG-LHE)

DOWNLIGHT ASYMMETRIC OPTIONS

Use this tool to understand how to specify Downlight Asymmetric for your project. The diagrams below show a linear run from power feed to ender. Specify DAO-L distributes light to the left or DAO-R distributes light to the right.

Downlight Asymmetric Optic Left (DAO-L)

Starter

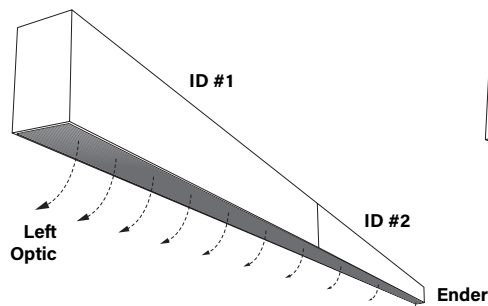

Downlight Asymmetric Optic Right (DAO-R)

Starter

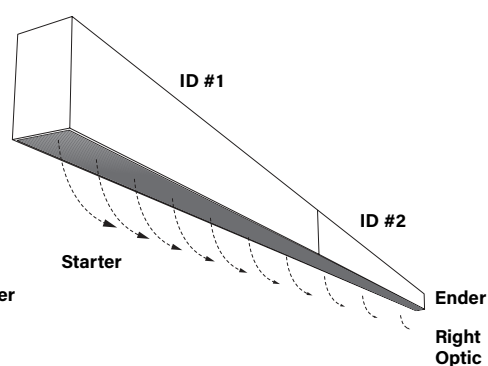

PREINSTALLED LABEL

For DAO, Preinstalled label on diffuser shows direction of light. Remove after installation.



¹ With a subtle ribbed appearance providing an asymmetric or batwing distribution

² Regressed only. Not available with Wall Wash

Protected by one or more US Patents: 8915613; D702,391; D702,390; D700,732

Submitted by:		Date:
Type:	Project:	
Ordering Info:		

High Performance 2" Aperture (HP-2) Surface Mount

Direct Photometry - 4' Luminaire 3500K

HP2-P-D-4'-V-837-SMIC-DSO

Downlight: Downlight Spread Optic

Efficacy: 91 lm/W

Total luminaire output: 3175 lumens (794 lm/ft)
35 watts (8.8 W/ft)

Peak Candela Value: 1161 @ 15°

CRI: 80 / CCT: 3700K

ITL LM79 Report 94139 (Family Correlated)

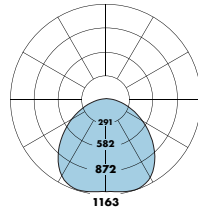

CANDELA DISTRIBUTION

	0.0	22.5	45.0	67.5	90.0	FLUX
0	1131	1131	1131	1131	1131	
5	1123	1124	1129	1134	1136	108
15	1060	1070	1116	1151	1161	314
25	942	972	1063	1121	1135	483
35	790	840	955	1005	1011	578
45	625	682	790	817	811	579
55	461	509	590	598	590	497
65	305	338	386	385	375	359
75	166	179	202	197	191	201
85	49	50	51	49	47	57
90	0	0	0	0	0	

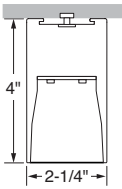

Direct Photometry - 4' Luminaire 3500K

HP2-P-D-V-837-SMIC-F

Downlight: Flush Diffuser

Efficacy: 89 lm/W

Total luminaire output: 3119 lumens (780 lm/ft)
35 watts (8.8 W/ft)

Peak Candela Value: 1294 @ 0°

CRI: 80 / CCT: 3700K

TL LM79 Report 85136 (Family Correlated)

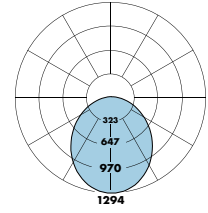

CANDELA DISTRIBUTION

	0.0	22.5	45.0	67.5	90.0	FLUX
0	1294	1294	1294	1294	1294	
5	1287	1286	1286	1285	1284	122
15	1225	1214	1213	1207	1199	341
25	1099	1084	1076	1055	1043	493
35	929	914	895	869	860	559
45	739	725	703	676	665	542
55	546	534	516	494	485	460
65	363	354	340	327	321	339
75	200	195	189	182	179	200
85	60	59	57	55	55	64
90	0	0	0	0	0	

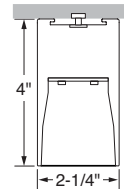

Information in chart below is for reference and based on ITL LM79 report 94139 (Family Correlated)

Total Light Output, 3700K, 80 CRI (Lumens) - 4' Luminaire

H'	V
2469	3175

Light Output, 3700K, 80 CRI (Lumens Per Foot)

H'	V
617	794

Single Mode Power, 3700K (Watts Per Foot)

H'	V
6.8	8.9

Dual Mode Power, 3700K (Watts Per Foot)

H'			V		
Occupied	LPD	Unoccupied	Occupied	LPD	Unoccupied
6.9	5.5	4.1	9.0	7.1	5.2

Efficacy, 3700K, 80 CRI (Lumens Per Watt)

H'	V
92	91

1 Family Correlation based on 4' luminaire 3700K Very High Output (V) test - 120V.
H - High Output, V - Very High Output

Information in chart below is for reference and based on ITL LM79 report 94139 (Family Correlated)

Total Light Output, 3700K, 80 CRI (Lumens) - 4' Luminaire

H'	V
2426	3119

Light Output, 3700K, 80 CRI (Lumens Per Foot)

H'	V
606	780

Single Mode Power, 3700K (Watts Per Foot)

H'	V
6.7	8.8

Dual Mode Power, 3700K (Watts Per Foot)

H'			V		
Occupied	LPD	Unoccupied	Occupied	LPD	Unoccupied
6.9	5.5	4.1	9.0	7.1	5.2

Efficacy, 3700K, 80 CRI (Lumens Per Watt)

H'	V
90	89

1 Family Correlation based on 4' luminaire 3700K Very High Output (V) test - 120V.
H - High Output, V - Very High Output

Wattage is Real Power. If you would like additional details to calculate Apparent Power, please contact your local Finelite representative.

- Use **Occupied Power** for total electrical load calculations. Use this value to estimate branch circuit lighting loads.
- Use **LPD Power** for lighting power density calculations. Only the power attributed to white light is required per NEMA LSD EB 84-202X. Power used toward germicidal disinfection has been removed for this calculation.
- Use **Unoccupied** and **Occupied Power** for energy calculations to determine the power consumed over time based on the use of the space.

Sample Lumen Adjustment Calculation

Lumen Adjustment Factors 80 CRI	
Indigo-Clean	
3200K	0.98
3700K	1.00
4300K	1.03

FLUSH - Very High Output (V), 3200K, 80 CRI
Lumen Adjustment Factor: 0.98
Total Light Output: 3119 lm x 0.98 = 3057 lm
Total Light Output per Foot: 780 lm/ft x 0.98 = 764 lm/ft.
watts/foot: 8.8 W/ft.

$$\text{Efficacy} = \frac{764 \frac{\text{lm}}{\text{ft}}}{8.8 \frac{\text{W}}{\text{ft}}} = 87 \text{ lm/W}$$

Protected by one or more US Patents: 8915613; D702,391; D702,390; D700,732

Submitted by:		Date:
Type:	Project:	
Ordering Info:		

Indigo Clean Dual Mode - Basic Wiring Diagram

WIRING DIAGRAM

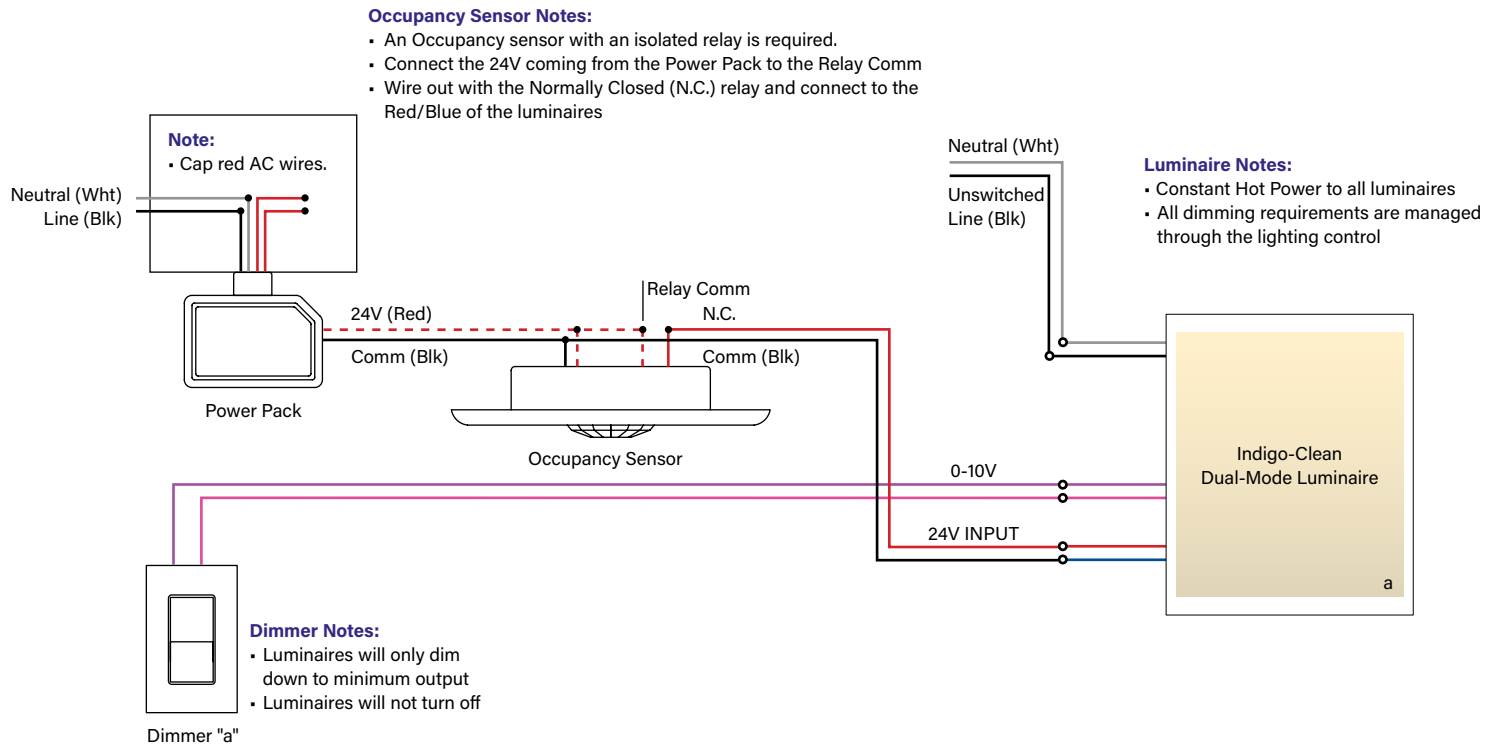

DUAL FEED DETAIL

CONTROL FEED

Blue / Red
Blue / Black

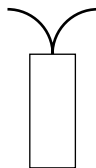

24V Dual Mode Control Pair

Each Indigo-Clean Dual Mode fixture will have a pair of #18awg low voltage wires

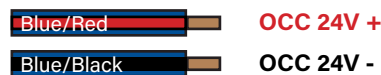

POWER FEED

Black, White, Green,
Purple, Pink

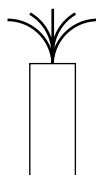

WIRING LEGEND	
Black	Hot
White	Neutral
Green	Ground
Purple	0-10V +
Pink	0-10V -