

HP-2 & HP-4 Circle Direct 2', 3', & 4' Installation Instructions

Overview

NOTES

- All power connections should be installed according to local/national codes by a Certified Electrician.
- This installation requires **proper support** as each luminaire is being installed.
- **DO NOT attempt to install with single operator.**



HELPFUL
VIDEO



0-10V
Dimming



Circle
Diffuser
Installation

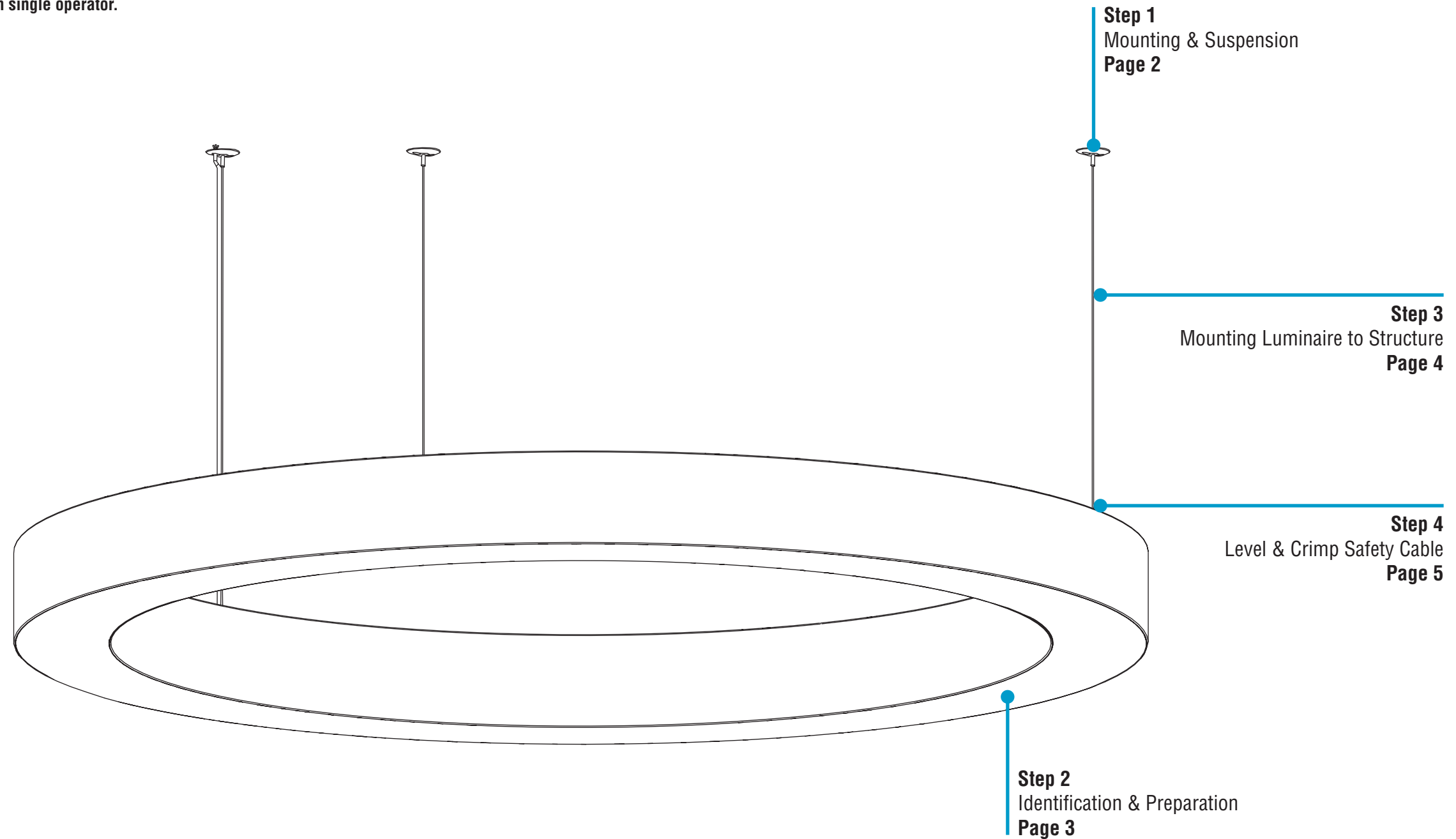

HP-2 & HP-4 Circle Direct 2', 3', & 4' Installation Instructions

Step 1 - Mounting & Suspension

Mounting Options Top-Down View

Option 1 T-Bar Mounting GridBox™ and Caddy Clips

- Locate power feed on luminaire.
- Install GridBox™ and electrical conduit at feed location.
- Install caddy clips at mounting point locations.
- All caddy clips are to be secured to structure, per local building codes.

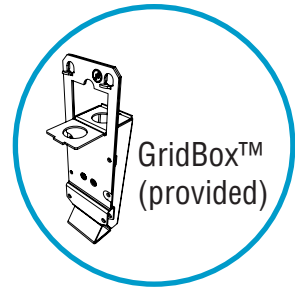

Option 2 Drywall (C4) or other hard surfaces* J-Box and Anchor Bolts

- Locate power feed on luminaire.
- Install J-Box and electrical conduit at feed location.
- Install anchor bolts at mounting point locations.
- All anchor bolts are to be secured to structure, per local building codes.

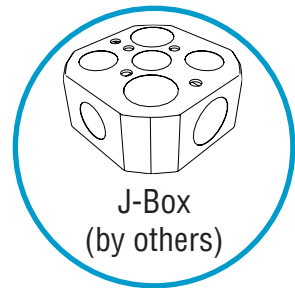

*Other hard surfaces include: wood, sheet metal panels, steel beams, concrete or masonry. Use hardware appropriate for each surface material type.

● = Feed Location

Mounting Location	Label	HP-2 & HP-4 Nominal Circle Diameter (ft)		
		2	3	4
Equal Triangle Location	T	17-5/16"	27-11/16"	38-1/8"
Reference Center Diameter	CD	20"	32"	44"

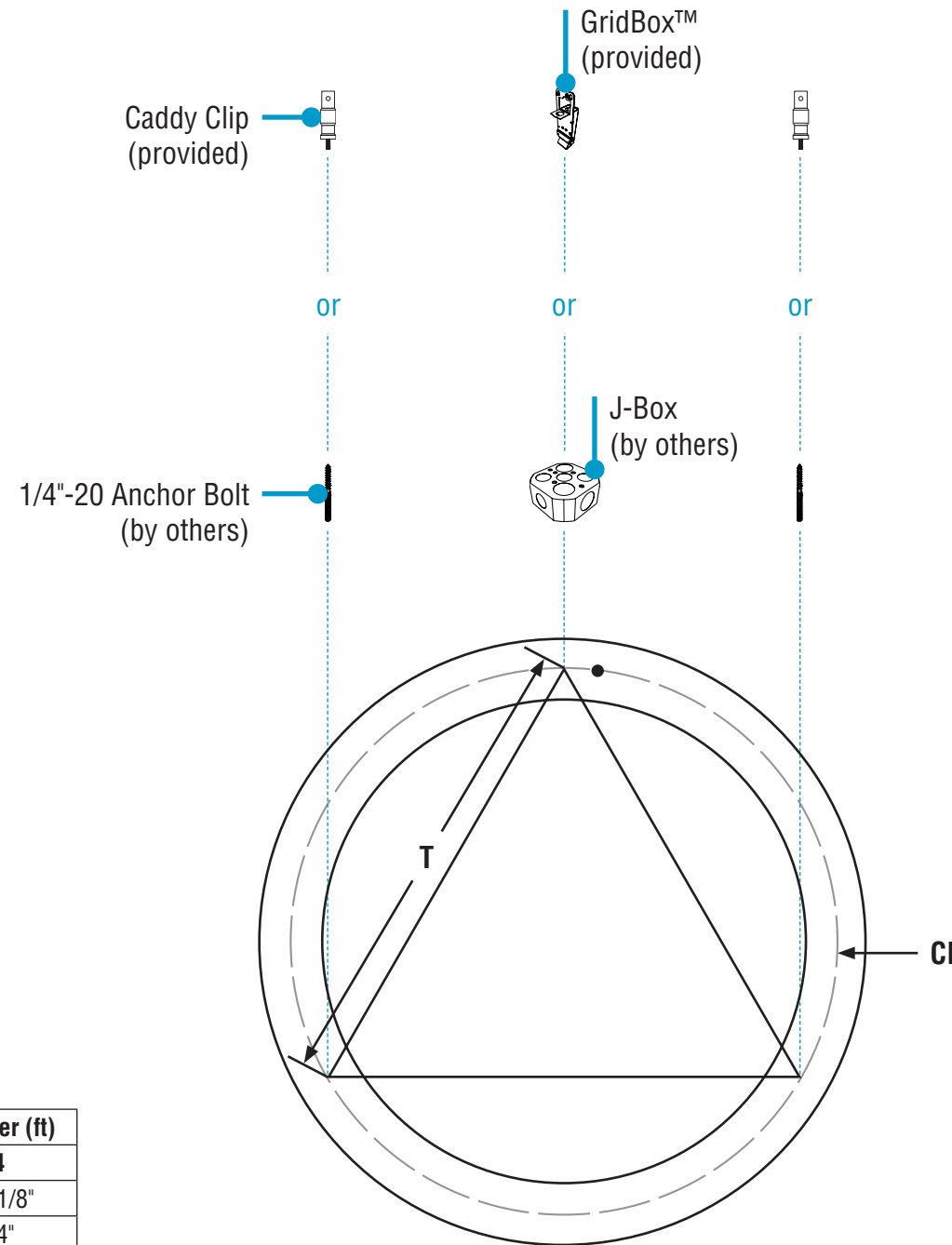

On-Grid Suspension Points Bottom-Up View

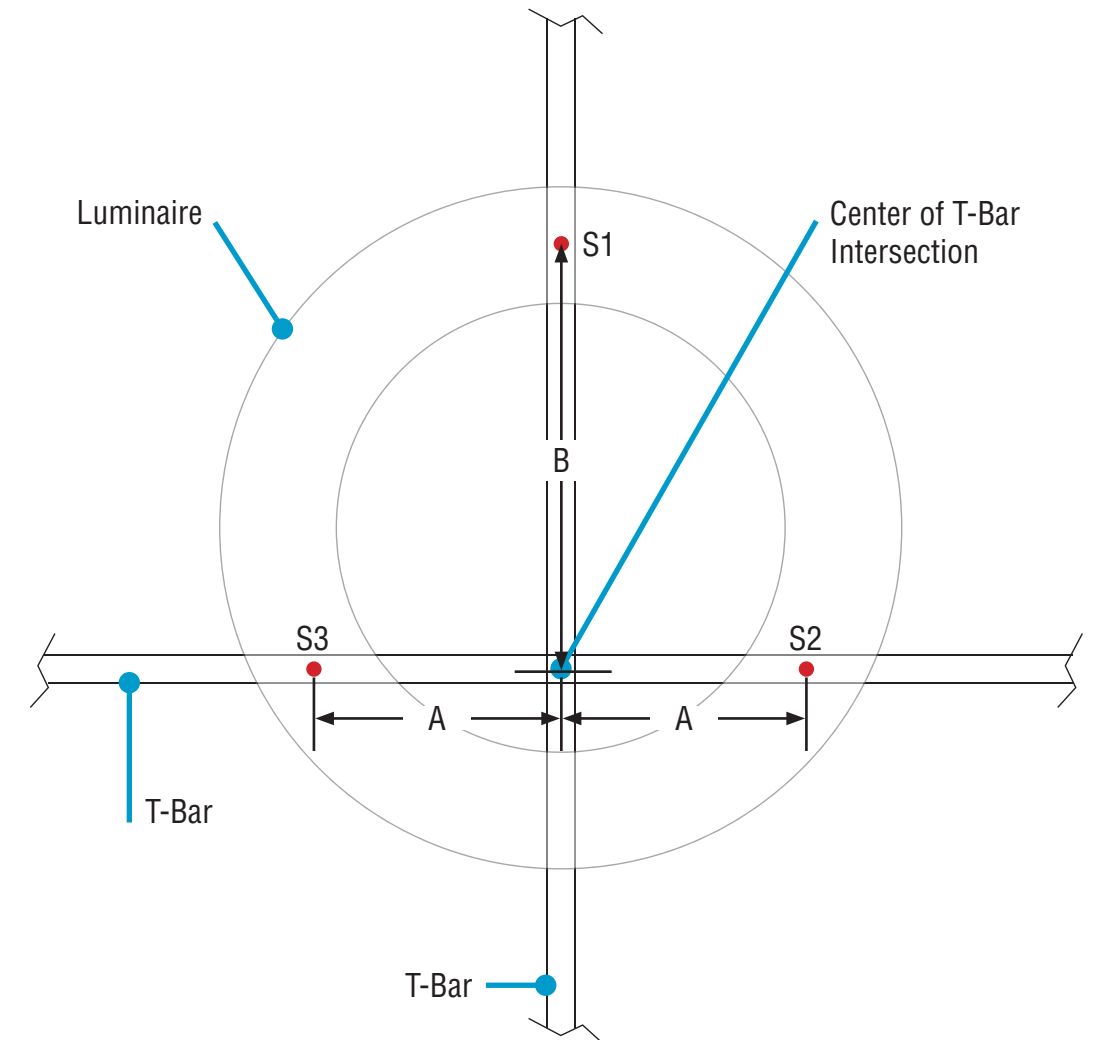

● = Suspension Point

On-Grid Suspension Location	Label	HP-2 & HP-4 Nominal Circle Diameter (ft)		
		2	3	4
Suspension Point 1 (S1) Distance	B	15"	24"	33"
Suspension Point 2 & 3 (S2, S3) Distance	A	8-11/16"	13-7/8"	19-1/16"

Measure from Center of T-Bar Intersection to Suspension Points

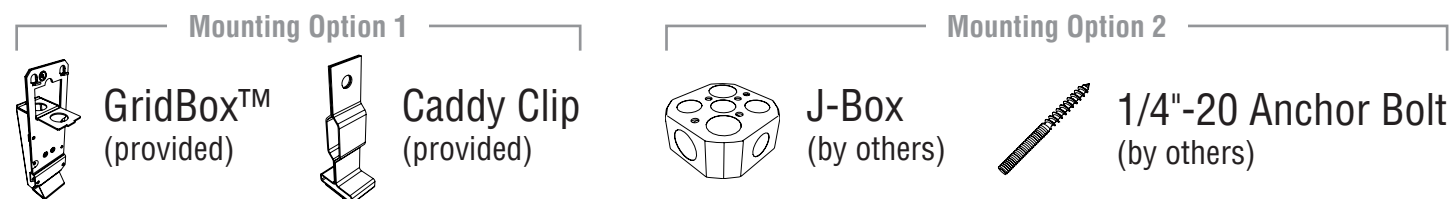

HP-2 & HP-4 Circle Direct 2', 3', & 4' Installation Instructions

Step 2 - Identification & Preparation

A. Identify Luminaires

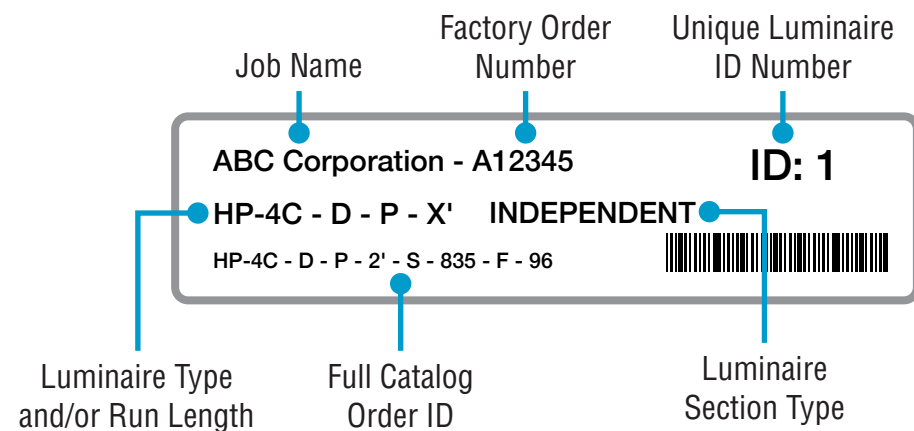

- Identify all luminaires by their ID label that can be found on the box and inside the luminaire.
- NOTE:** Exact location of labels in these areas may vary.
- Remove all luminaires from their box.
- Refer to Record Drawings that can be found in the hardware kit.



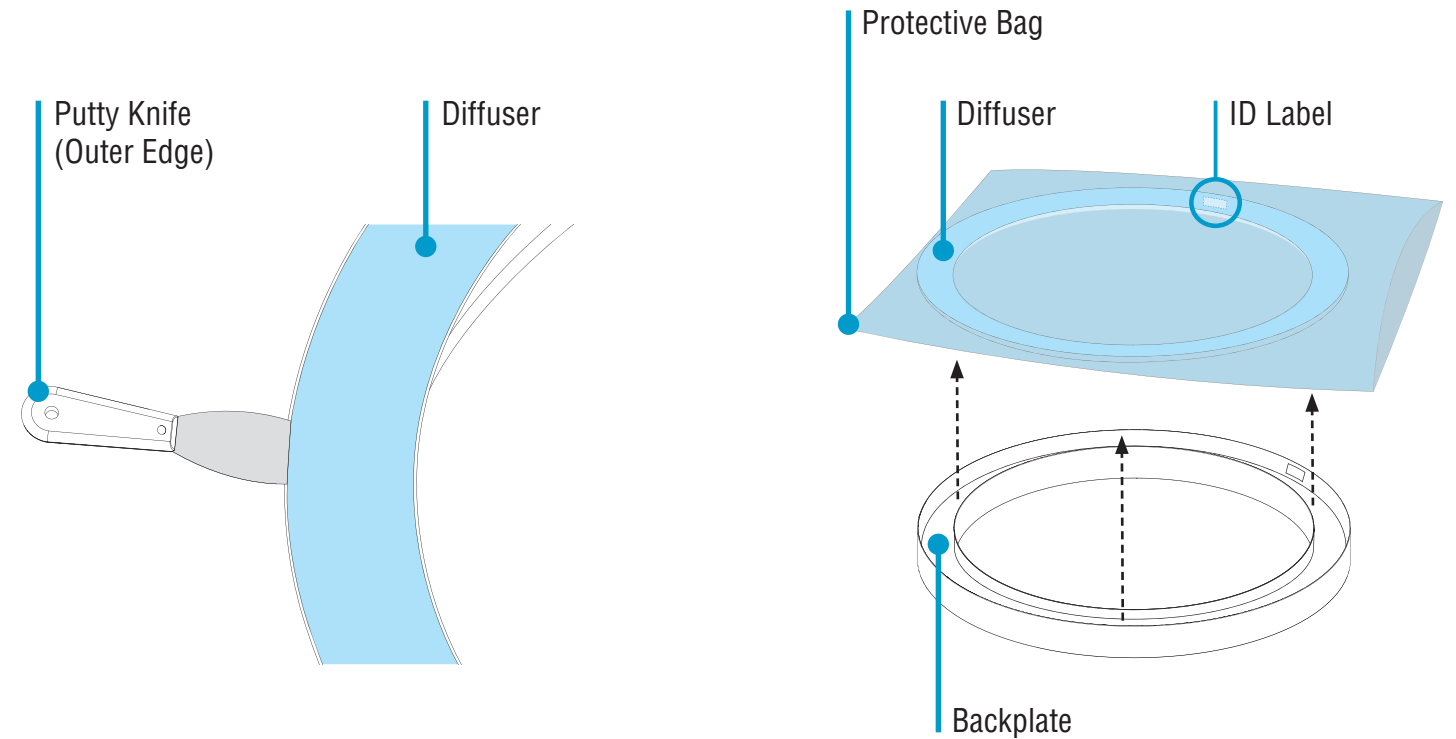





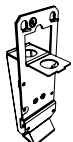

B. Remove Diffuser Top-Down View

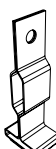

- NOTE:** Maximum width of putty knife is 2 inches.
- 1.** To release diffuser, carefully slide putty knife between outer edge of diffuser and luminaire.
- 2.** Then, directly across from you carefully slide putty knife between inner edge of diffuser and luminaire.
- 3.** Work your way around outer edge of diffuser to fully release it from luminaire.
- Keep diffuser inside protective bag.
- Set aside diffuser to prevent it from getting dirty or damaged.
- Ensure diffuser can be clearly identified back to corresponding luminaire.

Kitted Hardware

- Finelite has provided items listed here, with their Finelite part numbers. These items can be found in separate boxes shipped with the luminaire.
- Account for all parts and set aside until they are needed.
- All other hardware needed for this installation will be by others.

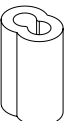
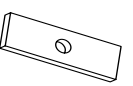
Mounting Option 1		Mounting Option 2			
	GridBox™ Part# 89159		3-1/2" Canopy Part# 89191		5" Canopy Part# 94085
	Dual GridBox™ Part# 89199 Mounting & Suspension p. 2, Step 1		3-1/2" Dual Feed Canopy Part# 89192 Mounting Luminaire to Structure p. 4, Step 3		5" Dual Feed Canopy Part# 94145 Mounting Luminaire to Structure p. 4, Step 3
	Caddy Clip C1 Ceiling - Part# 94001 C2 Ceiling - Part# 94020 C3 Ceiling - Part# 94029 Mounting & Suspension p. 2, Step 1		2" T-Bar Support Canopy Part# 89193 Mounting Luminaire to Structure p. 4, Step 3		2" Drywall Support Canopy Part# 94017 Mounting Luminaire to Structure p. 4, Step 3
					Cable Bushing Part# 94014
					Aircraft Cable 50" - Part# 94515-12 (Std.) 100" - Part# 94515-14 150" - Part# 94515-18 Mounting Luminaire to Structure p. 4, Step 3 Level & Crimp Safety Cable p. 5, Step 4
					Slip Ring w/ Set Screw Part# 94015 Mounting Luminaire to Structure p. 4, Step 3
					Safety Crimp Part# 94514 Level & Crimp Safety Cable p. 5, Step 4
					Safety Bar Part# 93500 Closing Luminaires p. 8, Step 6

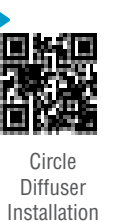

HP-2 & HP-4 Circle Direct 2', 3', & 4' Installation Instructions

Step 3 - Mounting Luminaire to Structure

A. Mount Luminaire to Structure

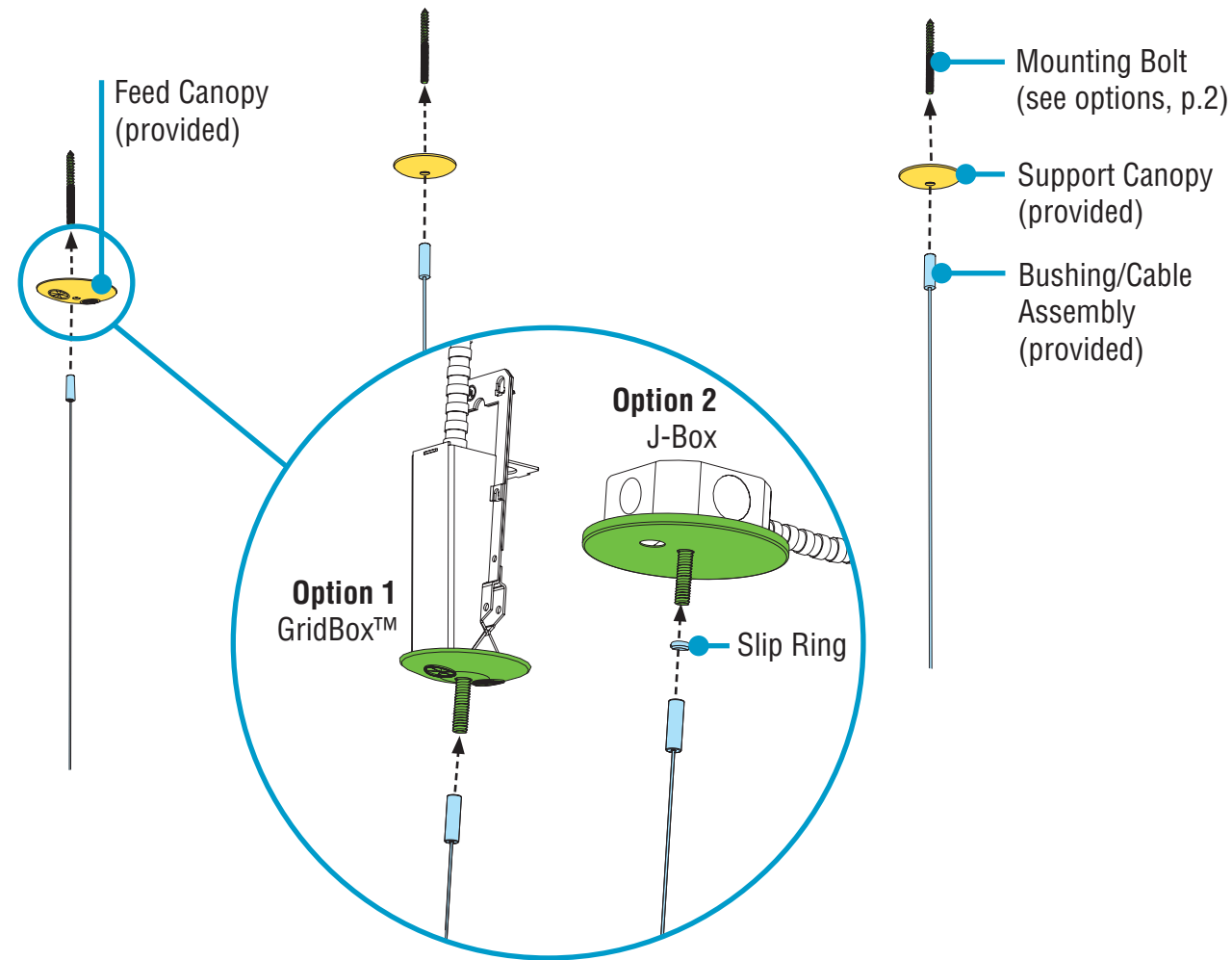

- Slide canopy appropriate for electrical type options onto mounting bolt (anchor bolt or caddy clip bolt).
- **(Option 2 only)** Thread the slip ring onto anchor bolts and secure with set screw at both mounting locations.
- Thread the bushing/cable assembly onto mounting bolts.
- While properly supporting luminaire, maneuver luminaire to ceiling and insert cables into cable grippers to support luminaire from the ceiling.

B. Make Electrical Connections

WIRING LEGEND		
Black	Hot	Line Voltage
White	Neutral	Line Voltage
Green	Ground	
Pink	Dimming	0-10V DC
Purple	Dimming	0-10V DC

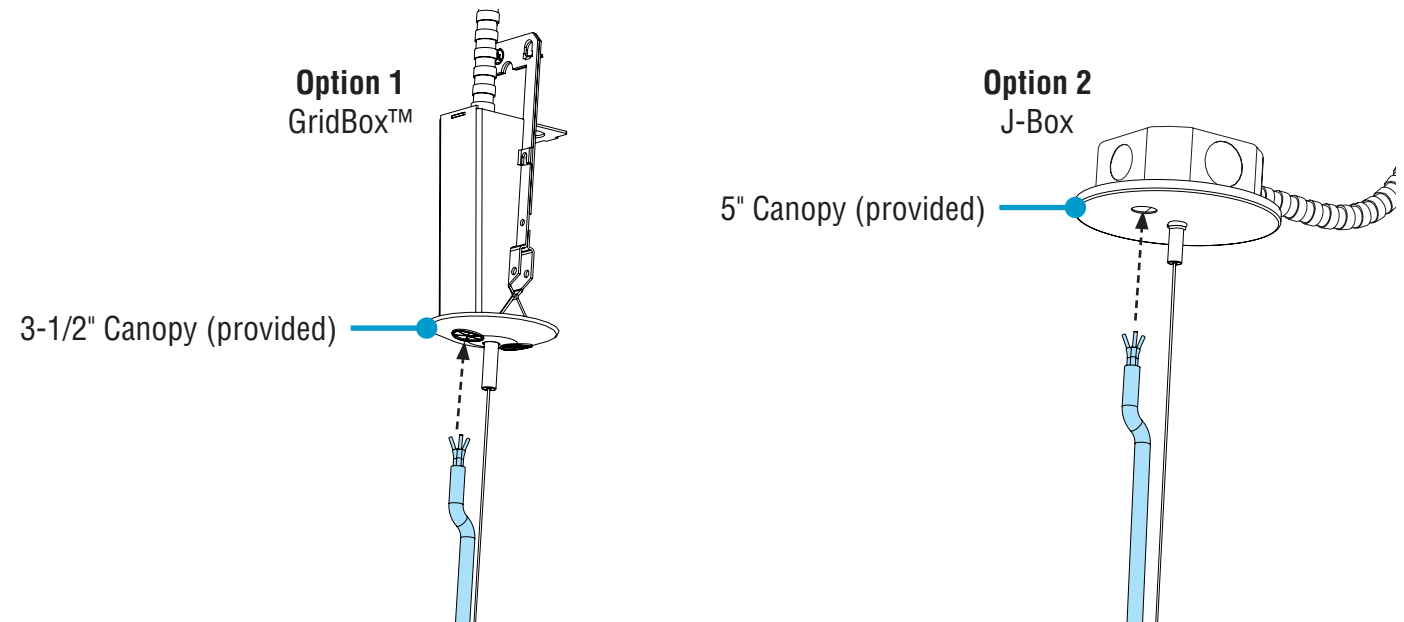

- **(Option 1)** Feed power cord through the 3-1/2" canopy and connect wires inside the GridBox™.
- **(Option 2)** Feed power cord through the 5" canopy and connect wires inside the J-Box.

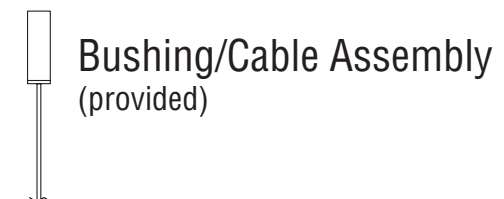
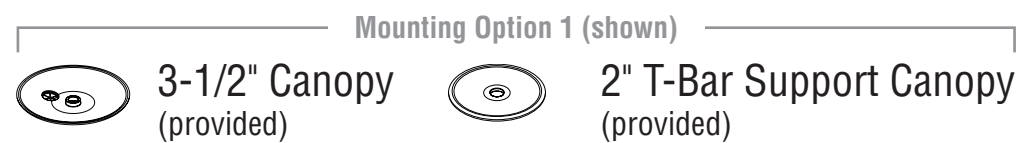

0-10V
Dimming

HP-2 & HP-4 Circle Direct 2', 3', & 4' Installation Instructions

Step 4 - Level & Crimp Safety Cable

A. Level, Crimp Safety Cable, & Safety Bar Top-Down View

HP-4

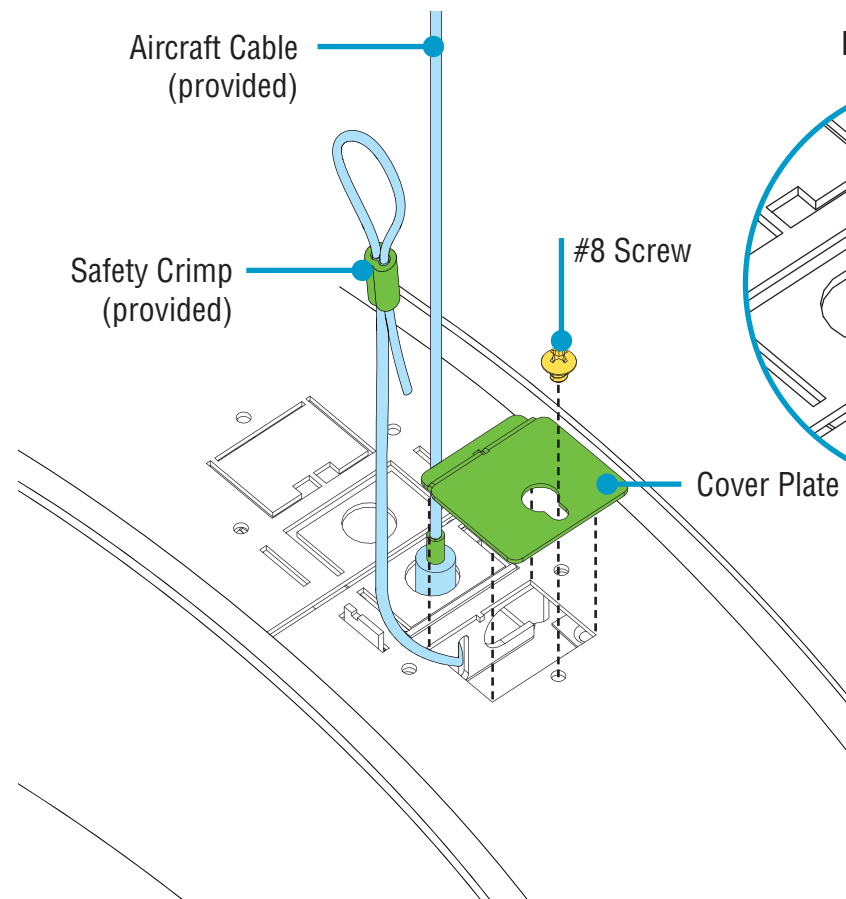

HP-4

- Remove #8 screw(s) and cover plate to gain access to safety cable.
- Ensure all leveling has been performed by depressing top of grippers to adjust cable lengths prior to applying safety crimp.
- Loop aircraft cable through safety crimp.
- Crimp, cut excess cable, and tuck back into luminaire body.
- Reinstall cover plate and #8 screw. Typical for each aircraft cable.



HP-2

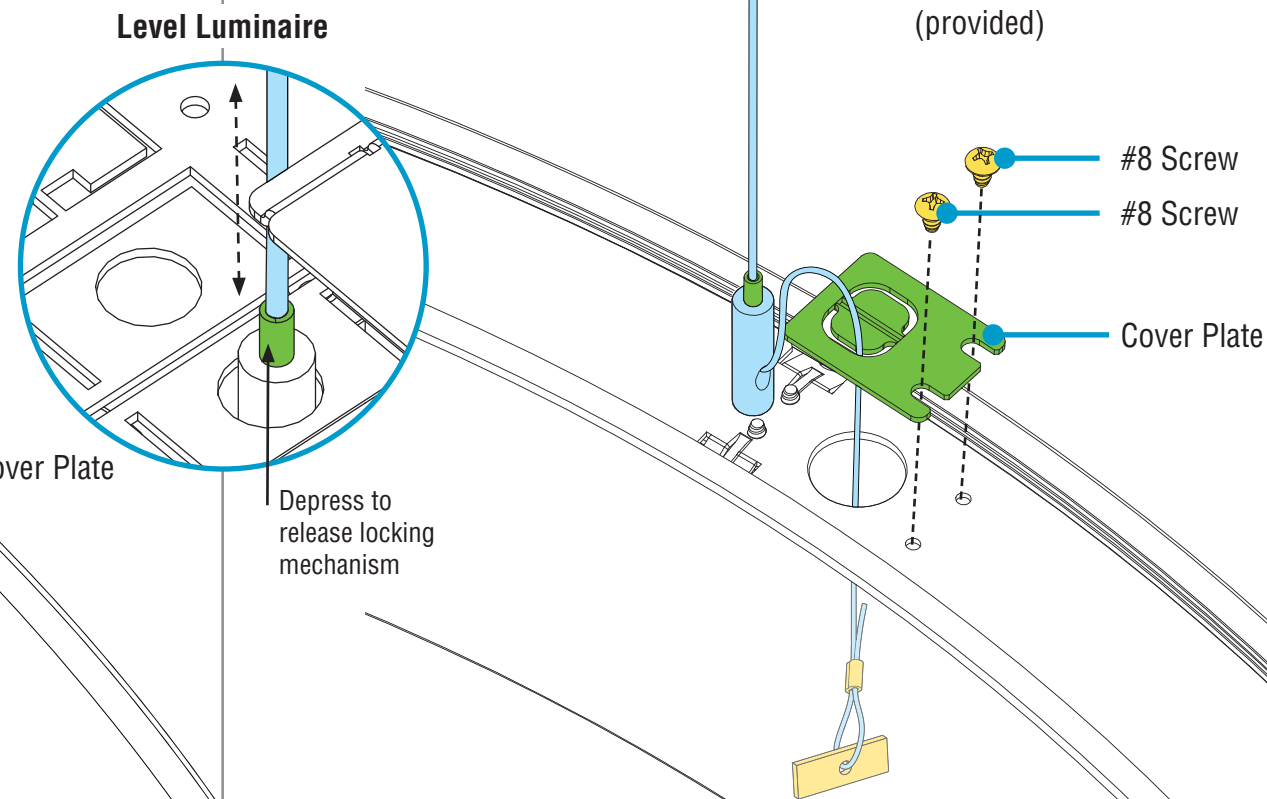

HP-2

- Remove #8 screw(s) and cover plate to gain access to safety cable.
- Ensure all leveling has been performed by depressing top of grippers to adjust cable lengths prior to applying safety crimp.
- Run excess cable through feed hole.
- Ensure all leveling has been performed prior to applying safety crimp.
- Run excess cable through feed hole.
- Loop cable through safety crimp and safety bar, then back through safety crimp.
- Crimp, then cut excess cable.
- Tuck safety loop inside luminaire.

B. Final Step - Replace Diffuser Side View

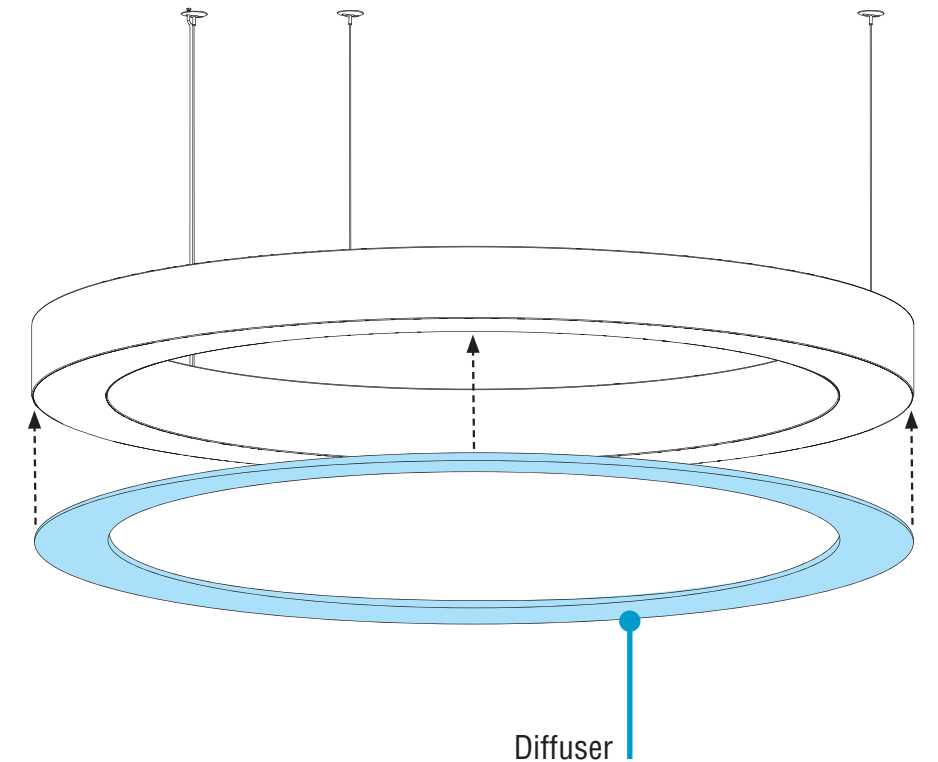

- Carefully remove diffuser from protective plastic bag.
- **CAUTION:** Wear gloves to keep diffuser surface clean.
- **CRITICAL:** Be sure to install correct diffuser to its corresponding luminaire ID.
- Install diffuser by snapping into place.
- **NOTE:** Push area of diffuser closest to you first until it snaps in place. Then work your way around the luminaire.
- Turn power on to luminaire.



Circle Diffuser Installation