

Submitted by:		Date:
Type:	Project:	
Ordering Info:		

High Performance 6" Aperture (HP-6) Recessed

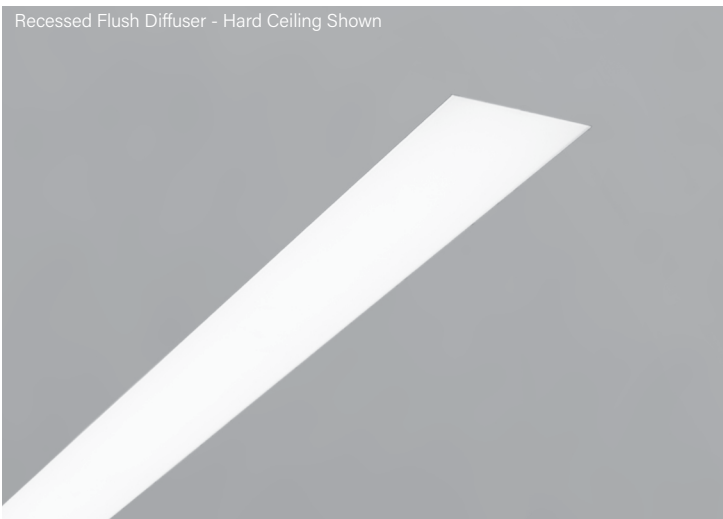

Indigo-Clean Technology is a Continuous Environmental Disinfection System that emits a narrow spectrum light that kills bacteria, Influenza-A¹, and SARS-CoV-2 – the virus that causes COVID-19¹ – and is proven effective by recently conducted independent lab testing. Unlike UV disinfection, Indigo-Clean Technology is designed to safely and continuously disinfect a space while it is fully occupied.

Single-Mode Indigo-Clean Technology utilizes a combination of blended white LEDs and 405nm LEDs on a single circuit board design. When the luminaires are on, the disinfection is active.

Dual-Mode Indigo-Clean Technology utilizes a mid-power of blended white LEDs and 405nm LEDs on a two circuit board design and full 405nm indigo light using automated controls to disinfect the space. When the space is unoccupied, it utilizes just the 405nm LEDs with increased output to increase disinfection efficacy.

These products are enrolled in the International Living Future Institute (ILFI) Declare 2.0 Program and is third-party verified with options achieving **Red List Approved** and **Red List Declared** status.

Note: see page 6 for all aesthetic options

CROSS SECTIONS

Recessed Direct

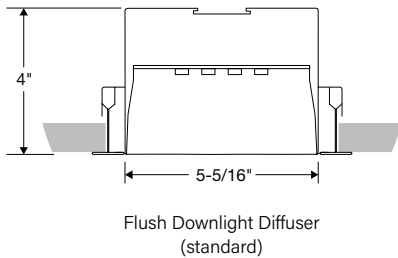

Recessed Direct with Air Return

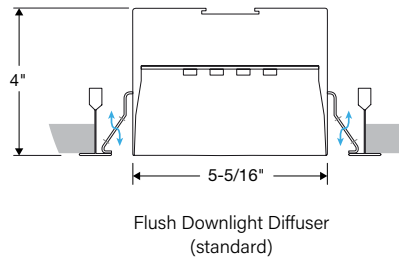

GET MORE WITH TAILORED LIGHTING

- Tailored Length
- Tailored Angle
- Tailored Color
- Tailored Output
- Tailored Control

ALSO AVAILABLE IN



Indigo-Clean is a registered trademark of Kenall Manufacturing Co., a Legrand Company

Submitted by:		Date:
Type:	Project:	
Ordering Info:		

High Performance 6" Aperture (HP-6) Recessed

BODY TYPE				OUTPUT AND LED TYPE	
Platform	Series Name	Luminaire Type	Luminaire Distribution	Total Length of Run	Downlight Output (Flush)
HP - High Performance	6	R - Recessed	D - Direct	Minimum 2' section length. Increments accurate to 1/16" (±1/32"), standard. 12" maximum section length.	H - High (670 lm/ft) V - Very High (862 lm/ft) TL - Tailored: _____ lm/ft*

* Specify lm/ft of outputs between High (H) and Very High (V). Consult factory for tailored lumen output outside of this range.

OUTPUT AND LED TYPE		MECHANICAL OPTIONS		ELECTRICAL OPTIONS	
LED CRI/CCT	Downlight	Reflector System	Voltage	Circuiting ¹	
832-SMIC - 80 CRI, 3200K Single Mode Indigo-Clean	F - Flush (standard)	96LG - 96 Low Gloss White	120 - 120 Voltage 277 - 277 Voltage 347 - 347 Voltage	SC - Single Circuit* One single circuit in a run	
837-SMIC - 80 CRI, 3700K Single Mode Indigo-Clean				MC - Multi-Circuit* More than one switch leg or zone. Factory shop drawings required	
843-SMIC - 80 CRI, 4300K Single Mode Indigo-Clean					
832-DMIC - 80 CRI, 3200K Dual Mode Indigo-Clean					
837-DMIC - 80 CRI, 3700K Dual Mode Indigo-Clean					
843-DMIC - 80 CRI, 4300K Dual Mode Indigo-Clean			* Battery, Night Light, and Emergency to Generator circuits are in addition to the normal luminaire circuit(s)		

ELECTRICAL OPTIONS		MOUNTING OPTIONS		OTHER OPTIONS			
Driver Selection		Ceiling Hardware Type		Endcap Style	Finish		
0-10V Driver Options FC-10% - 0-10V 10% (standard) FC-1% - 0-10V 1% OTi-10% - EldoLED OTi, 0-10V 10% ² OTi-1% - EldoLED OTi, 0-10V 1% ² ELD-10V-0% - EldoLED SOLOdrive, 0-10V 0.1% DALI Driver Options FC-DALI-1% - DALI 1% DXL-DALI-1% - EldoLED Dexal, 1% ELD-DALI-0% - EldoLED SOLOdrive, 0.1%		DMX Driver Options ELD-DMX - EldoLED POWERdrive, 0.1% Lutron Driver Options LUT-ES1 - Lutron, Ecosystem 1% LUT-2W - Lutron, 2-wire (120V only) 1% See Page 3 for additional driver options and details		C1 - 15/16" T-Bar C1T - 15/16" Tegular C2 - 9/16" T-Bar C2T - 9/16" Tegular C3 - Screw Slot C3F - Flush Screw Slot SF - Spackle Flange VF - Visible Flange TZ6 - Tech Zone 6" (C2, C2T, C3, C3F)		FE - Flat Endcap (standard)	SW - Signal White (standard) FB - Finelite Black SA - Satin Aluminum #### - RAL Color Code ³

OTHER OPTIONS			
Emergency Style (Optional) See page 5 Backup Battery table	Integrated Sensor (Optional)	Special Options (Optional)	Air Return (Optional)
LGD18W - Legrand 18W Brand Battery Back-up LGD10W - Legrand 10W Brand Battery Back-up EM/GEN - Emergency to Generator NL - Night Light BSL722 - Bodine Battery Back up BSL310LP - Bodine Battery Back up Low Profile GTD - Generator Transfer Device ALCR - Automatic Load Control Relay	OBO - Occupancy OBD - Daylight W601 - Wattstopper Wireless Sensor ⁴ OBE - Enlighted ⁵ CLM - Encelium Sensor RE7 - nLight Air Sensor AOCC-W - Lutron Athena Sensor (Device Color White) ⁶ AOCC-B - Lutron Athena Sensor (Device Color Black) ⁶ ARF-W - Lutron Athena RF (Device Color White) ⁶ ARF-B - Lutron Athena RF (Device Color Black) ⁶ VOCC - Lutron Vive Sensor ⁷ VRF - Lutron Vive RF ⁷ Integrated Sensor not available for Dual-Mode	CP - Chicago Plenum FLX - Flex Whip RLA - Red List Approved RLD - Red List Declared	AR - Air Return

¹ Contact factory for switching options
² Add DTO to gain "Dim to Off" functionality (FC-10% - DTO, FC-1% - DTO). Not available with Dual-Mode.
³ 20 business days lead time for color
⁴ LMFS-601 w/ 0-10V driver(s) and LMFI-111, up to 6 drivers may be connected.
 LMFS-601 w/ Dali driver, only 1 driver can be connected.
⁵ Enlighted components installed by Finelite, provided by others
⁶ 0-10V Drivers - **AOCC** up to 10 drivers may be connected; **ARF** up to 40 drivers may be connected
 DALI Drivers - **AOCC & ARF** up to 4 drivers can be connected.
⁷ Lutron Vive Integrated Sensors require a DALI driver

Submitted by:		Date:
Type:	Project:	
Ordering Info:		

High Performance 6" Aperture (HP-6) Recessed

SUPPLEMENTARY DRIVER PAGE

0-10V Driver Options

FC-10%	Factory Choice, 0-10V 10% Dimming (Linear)
FC-10%-DTO	Factory Choice, 0-10V 10% Dimming, Dim-to-Off (Linear)
FC-1%	Factory Choice, 0-10V 1% Dimming (Linear)
FC-1%-DTO	Factory Choice, 0-10V 1% Dimming, Dim-to-Off (Linear)
ELD-10V-0%	EldoLED SOLOdrive, 0-10V 0.1% Dimming (Linear)
ELD-10V-1%	EldoLED ECOdrive, 0-10V 1% Dimming (Linear)
OTi-10%	EldoLED OTi, 0-10V 10% Dimming (Linear)
OTi-10%-DTO	EldoLED OTi, 0-10V 10% Dimming, Dim-to-Off (Linear)
OTi-1%	EldoLED OTi, 0-10V 1% Dimming (Linear)
OTi-1%-DTO	EldoLED OTi, 0-10V 1% Dimming, Dim-to-Off (Linear)

DALI Driver Options

FC-DALI-1%	Factory Choice, DALI 1% Dimming (Logarithmic)
DXL-DALI-1%	EldoLED Dexal, DALI 1% Dimming (Logarithmic)
ELD-DALI-0%	EldoLED SOLOdrive, DALI 0.1% Dimming (Logarithmic)
ELD-DALI-1%	EldoLED ECOdrive, DALI 1% Dimming (Logarithmic)

DMX Driver Options

ELD-DMX	EldoLED POWERdrive, DMX 0.1% Dimming (8 Bit, 1CH) (Linear)
ELD-DMX-16	EldoLED POWERdrive, DMX 0.1% Dimming (16 Bit, 2CH) (Linear)

Lutron Driver Options

LUT-ES1	Lutron, Ecosystem 1% Dimming
LUT-2W	Lutron, 2-wire (120V only) 1% Dimming

Submitted by:		Date:
Type:	Project:	
Ordering Info:		

High Performance 6" Aperture (HP-6) Recessed

SPECIFICATIONS

BODY TYPE

CONSTRUCTION: Precision-cut 6061-T6 extruded aluminum body. Internal joiner system, plug-together wiring, standard.

LENGTHS: Any length, 2' minimum, in increments down to 1/16" ($\pm 1/32"$). 12' maximum section length.

MITERED CORNERS: Fully illuminated 90° corners have double-diffusers to ensure against light leaks. Custom angles are available (90° minimum on inside corners.) Consult factory for tailored lighting options.

OUTPUT AND LED TYPE

LIGHT OUTPUT: Lumen packages available for **HP-6 D:** High (**H**), and Very High (**V**). For Tailored Outputs outside of range from High (**H**) to Very High (**V**), consult factory. Light engines are replaceable.

INDIGO-CLEAN TECHNOLOGY: Indigo-Clean Technology utilizes a combination of blended white LEDs, and safe 405nm LEDs to continually disinfect a space and kill bacteria, Influenza-A¹, and SARS-CoV-2 – the virus that causes COVID-19¹. Unlike UV disinfection, Indigo-Clean Technology is designed to safely and continuously disinfect a space while it is fully occupied. When the Indigo-Clean Technology light is on, disinfection is active. For optimum performance, continuously provide an average 50-60 footcandles on the work plane and high touch surfaces (24/7). Dimming generally reduces effectiveness and increases the variation in the disinfecting light's visual appearance.

Single-Mode Indigo-Clean Technology: Continuous environmental disinfection system that uses a blended white LEDs and 405nm Indigo-Clean LEDs. The narrow spectrum light provides a safe visible light that disinfects the space. When the light is on, disinfection is active.

Dual-Mode Indigo-Clean Technology: Utilizes a two circuit board design. When the space is occupied it utilizes a combination of blended white LEDs and 405nm LEDs. When the space is unoccupied, it utilizes just the 405nm LEDs with increased output to increase disinfection efficacy.

Dual-Mode Indigo-Clean Technology Controller: It is a low-voltage internal device that determines the operational mode based on the input received from the external automated controls. An Off manual push will not turn the lights off, but rather turn the lights to Blue Mode. Please refer to Dual-Mode Application Guide for wiring diagram. Dim to Off not available.

MECHANICAL/OPTICAL OPTIONS

DOWNLIGHT OPTION: 12' maximum diffuser length. Flush frost white snap-in diffuser standard, 73% transmissive, 99% diffusion. Internal secondary diffusers at corners ensure visually seamless, uniform, continuous illumination. Available with Flush (**F**) downlight diffuser. Consult factory for more tailored lumen outputs.

LUMEN MAINTENANCE: White LEDs: 90% of initial light output (L90) at 100,000+ hours; 70% of initial light output (L70) at 200,000+ hours. 405nm LEDs: 70% of initial output at L70 @ 60,000 hours.

REFLECTORS: Die-formed 20-gauge cold-rolled steel reflectors finished in 96LG High Reflectance white powder coat paint.

ELECTRICAL OPTIONS

STATIC WHITE FEED: Standard with one 18-gauge/5-conductor single-circuit feed wire. 14-gauge feed wire used when luminaire current exceeds 5 amps.

STATIC WHITE DRIVER: Replaceable 120V, 277V, and 347V constant current reduction dimming driver standard. Can be wired dimming or non-dimming. 0-10V dimming controls with a range of 10%- 100% standard. Dimming to 1% available. Driver is fully accessible from below the ceiling.

- **Power Factor:** ≥ 0.9
- **Total Harmonic Distortion (THD):** <20%
- **Expected driver lifetime:** 100,000 hours

LUTRON DRIVER OPTIONS:

- **LUT-ES1 (LDE1)** - (Hi-lume 1% EcoSystem with Soft-On, Fade-to-Black dimming (LDE1 series))

MOUNTING OPTIONS

HANGING HARDWARE:

- **Recessed T-Bar:** Standard bracket design works with most lay-in ceiling types. Brackets secure luminaire to the ceiling grid from above. Tie-in T-Bar brackets connect the luminaire to the T-Bar for securing to structure. Consult local codes for tie-wire recommendations.
- **Recessed Spackle Flange:** Drywall surfaces (walls or ceilings): 1/4" - 20 stud and nut (provided by others). Mounted with three equidistant suspension points.

OTHER OPTIONS

ENDCAPS: Flat endcaps (**FE**) at each end of run add 1/16" to each end of luminaire.

Continued

¹ [Indigo-Clean Research Reports](#)

Submitted by:		Date:
Type:	Project:	
Ordering Info:		

High Performance 6" Aperture (HP-6) Recessed

SPECIFICATIONS

EMERGENCY STYLE: Optional emergency to generator/inverter wiring, internal generator transfer switch, nightlight wiring, step-dimming driver, backup battery.

Backup Battery		
	Legrand 18W	Legrand 10W / Bodine BSL310LP
HP6-R-D		
Min. Housing Length	6'	4'
EM Lumen Output	1724	1026
EM Section Illum.	2'	2' or 4'

Based on 3700K and 80-CRI.

Bodine GTD and Legrand ALCR Min. Length	
Configuration	Min Length
Generator	2'
Generator + OCC	2'
Daylight	2'
Generator + Daylight	2'

INTEGRATED SENSORS: Integrated PIR (Passive Infrared) Occupancy (OBO) or Daylight Sensors (OBD) available with Flush and Bottom Glow downlight diffusers. PIR sensors not recommended for stairwell applications. Refer to Occupancy Sensor & Daylight Sensor tech sheet and the Embedded Intelligence landing page for more information and additional sensor options.

PATENT: Indigo-Clean products and technology covered by U.S. Patent No.US 9,039,966 and US 8,398,264. Product may also be covered by patents found at www.kenall.com/patents.

FINISHES: Finelite Signal White (SW) powder coat, Finelite Black (RAL 9005) with semi gloss fine texture (FB) and Satin Aluminum (SA) are standard. Optional Adders: 179 RAL colors².

LABELS: Luminaire and electrical components are ETL-listed conforming to UL 1598 in the U.S.A. and CAN/CSA C22.2 No. 250.0 in Canada. In accordance with NEC Code 410.130 (G), this luminaire contains an internal driver disconnect. UL 924 and UL 2108 - PoE options available on request. EPA Est.No. 99530-CA-2. These fixtures are rated for Damp Location. Chicago Plenum options available for C1, C2, or C3 suspension using our GridBox. Finelite products use electronic components that are RoHS compliant, and the mechanical components of the luminaire have been verified to not knowingly contain any restricted substances listed per RoHS Directive 2015/863. Consult factory for tailored lighting options. Finelite

makes the specification process easy when putting healthier products on your projects. Simply add – **RLA** (Red List Approved) or – **RLD** (Red List Declared) to your part number.

WEIGHT³: R - 3.7 lb/ft

WARRANTY: 5-year performance-based warranty on all standard components. Optional accessories such as emergency battery packs are covered by their individual manufacturer warranties.

AIR HANDLING INFORMATION

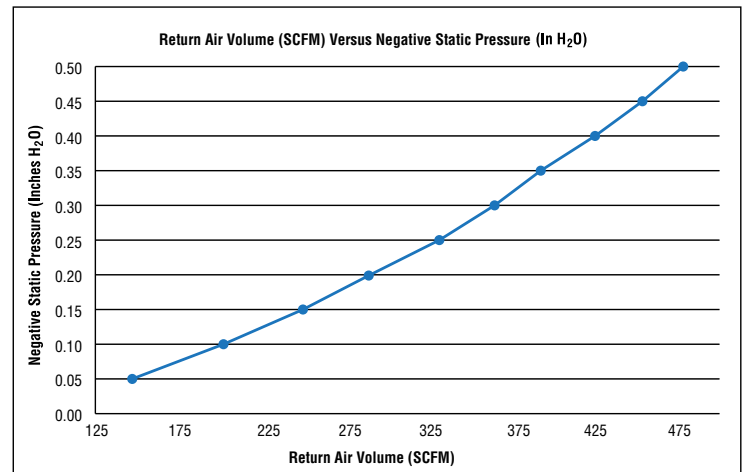

AIR RETURN: Luminaire tested in accordance with ADC1062 and ASHRAE 70. Air Return slots positioned along outside edge of luminaire. Consult factory for tailored lighting options.

² 20 business days lead time for color

³ Excludes Battery Backup and Generator Transfer Device weight

Submitted by:		Date:
Type:	Project:	
Ordering Info:		

High Performance 6" Aperture (HP-6) Recessed

HARD CEILING MOUNTING OPTIONS

Threaded Rod Option

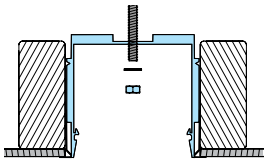

Screw Mount Option

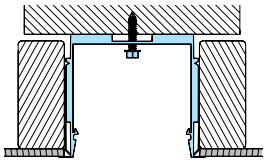

Mounting Location for Securing to Structure

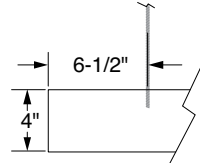

Two mounting options: threaded rod and screw mounting options. Mounting locations are located on each end of the luminaire. Mounting location is 6" away from each end of luminaire.

T-BAR INSTALLATION

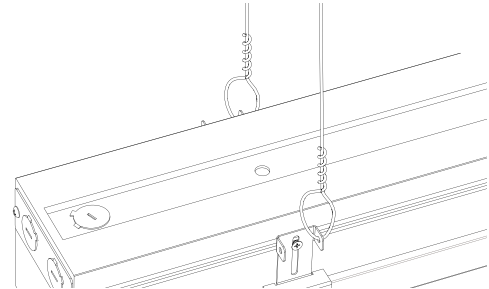

HP-6 R and HP-6 EO R for T-Bar installations comes standard with a splice plate at the end of the luminaire. Mounting brackets (supplied) secure the luminaire to T-Bar and provide support to structure location. All even foot length (2, 4, 6, ...) luminaire runs are reduced in length by an appropriate amount to fit within typical 2x2 and 2x4 T-Bar grid systems. For uncommon T-Bar systems please consult factory.

GRID LENGTH DETAIL - 4' EXAMPLE

15/16" T-Bar

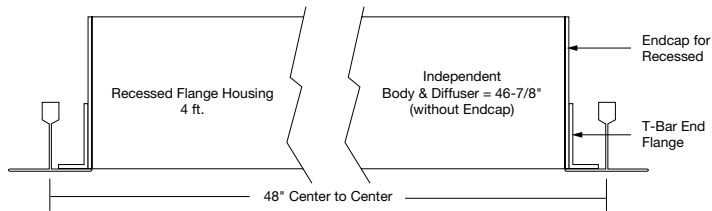

9/16" T-Bar

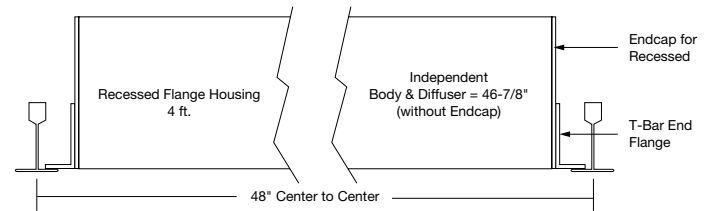

9/16" Screw Slot

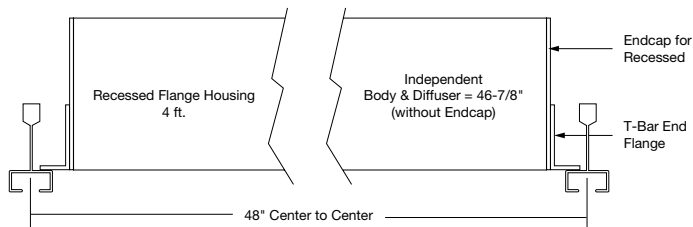

HARD CEILING LENGTH DETAIL - 4' EXAMPLE

Spackle Flange

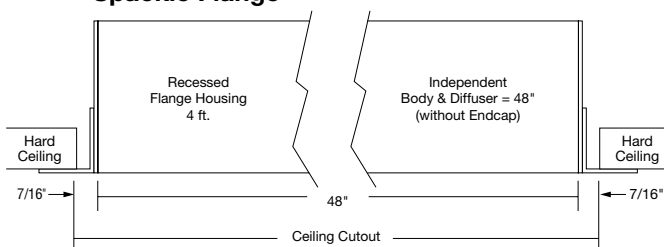

Visible Flange

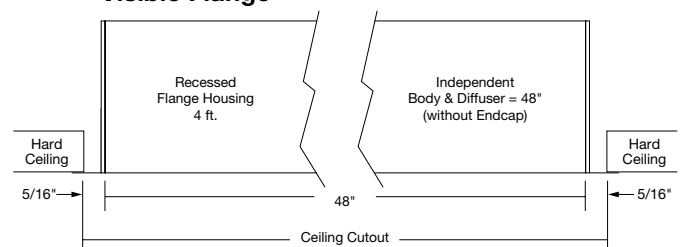

Protected by one or more US Patents: 8915613; D702,391; D702,390; D700,732

Submitted by:		Date:
Type:	Project:	
Ordering Info:		

High Performance 6" Aperture (HP-6) Recessed

RECESSED MOUNTING TYPES - T-BAR

Rough-In Dimensions

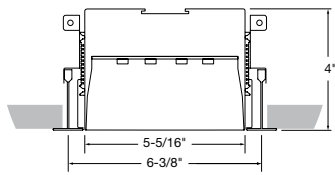

15/16" T-Bar (C1)

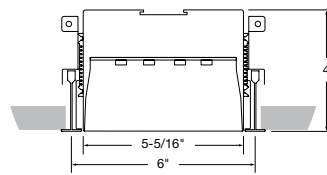

9/16" T-Bar (C2)

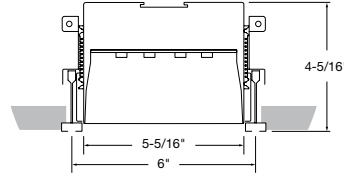

Standard Screw Slot (C3)

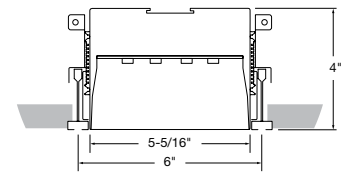

Flush Screw Slot (C3F)

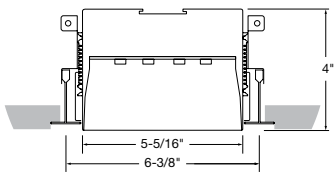

15/16" Tegular (C1T)

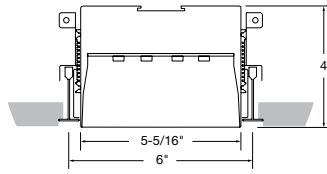

9/16" Tegular (C2T)

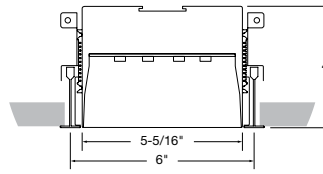

Tech Zone 6" (TZ6)
9/16" T-Bar (C2)

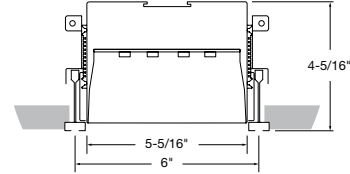

Tech Zone 6" (TZ6)
Standard Screw Slot (C3)

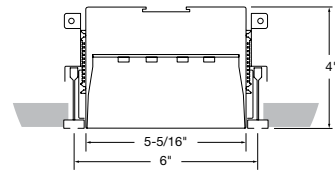

Tech Zone 6" (TZ6)
Flush Screw Slot (C3F)

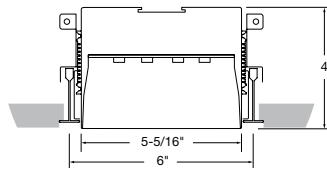

Tech Zone 6" (TZ6)
9/16" Tegular (C2T)

RECESSED MOUNTING TYPES - CUTOUT DIMENSIONS

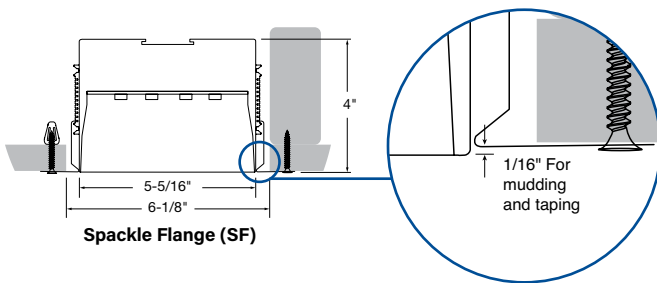

Spackle Flange (SF)

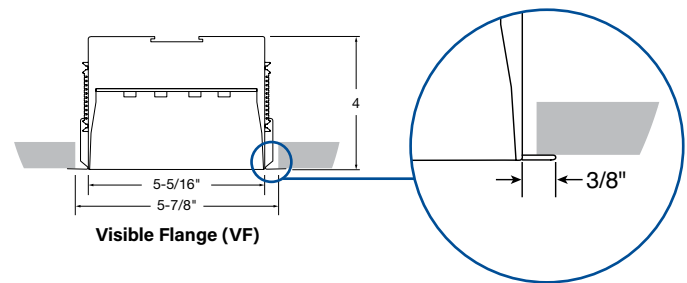

Visible Flange (VF)

HOUSING

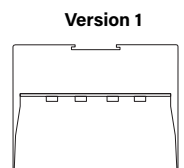

Version 1

Ceiling Option VF

No modification on flange

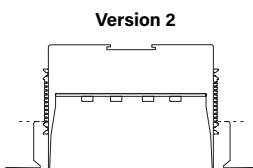

Version 2

Ceiling Options
C1T, C2T, C3F, SF, TZ6

Flange can be modify individually
on each side of the housing

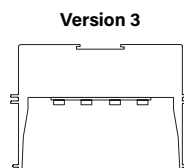

Version 3

Ceiling Options
C1, C2, C3

No modification on flange

Note: +/- 1/16"

Protected by one or more US Patents: 8915613; D702,391; D702,390; D700,732

Page 7

Submitted by:		Date:
Type:	Project:	
Ordering Info:		

High Performance 6" Aperture (HP-6) Recessed

AIR RETURN MOUNTING TYPES - T-BAR

Rough-In Dimensions

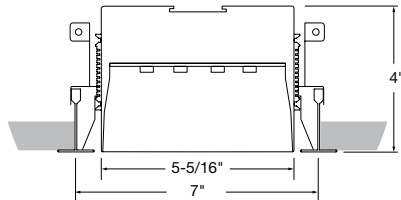

15/16" T-Bar (C1)

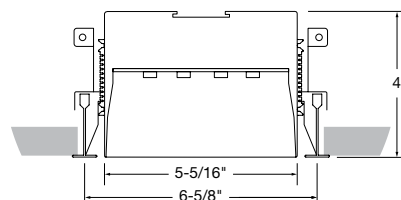

9/16" T-Bar (C2)

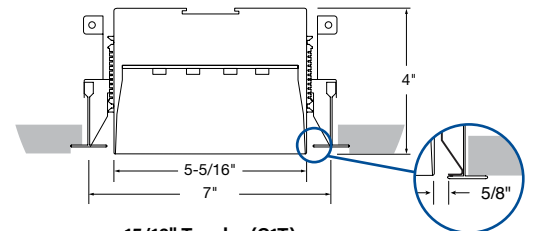

15/16" Tegular (C1T)

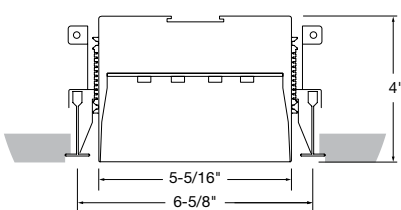

9/16" Tegular (C2T)

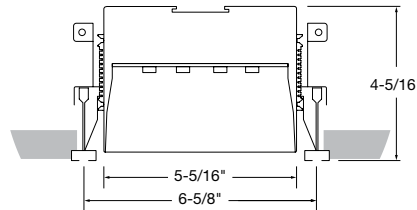

Standard Screw Slot (C3)

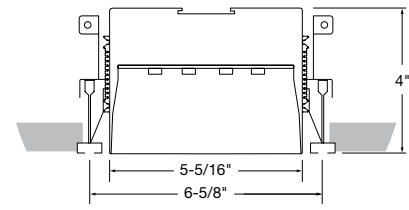

Flush Screw Slot (C3F)

AIR RETURN



Note: +/- 1/16"

Protected by one or more US Patents: 8915613; D702,391; D702,390; D700,732

Page 8

Submitted by:		Date:
Type:	Project:	
Ordering Info:		

High Performance 6" Aperture (HP-6) Recessed

Direct Photometry - 4' Luminaire 3700K

HP6-R-D-4'-V-837-F

Downlight: Flush Diffuser

Efficacy: 98 lm/W

Total luminaire output: 3446 lumens (862 lm/ft)
35 watts (8.8 W/ft)

Peak Candela Value: 1242 @ 0°

CRI: 80 / CCT: 3700K

TL LM79 Report 85124 (Family Correlated)

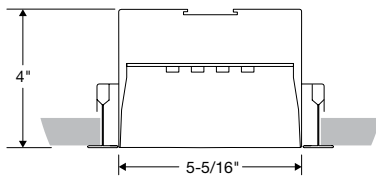
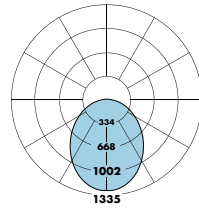

CANDELA DISTRIBUTION

	0.0	22.5	45.0	67.5	90.0	FLUX
0	1242	1242	1242	1242	1242	
5	1235	1235	1234	1234	1234	126
15	1179	1170	1175	1174	1168	355
25	1069	1056	1060	1054	1048	523
35	917	906	906	897	891	607
45	743	734	733	723	719	606
55	560	553	551	543	539	529
65	375	374	373	368	367	395
75	204	204	205	203	204	233
85	58	59	60	61	60	71
90	0	0	0	0	0	

Information in chart below is for reference and based on ITL LM79 report 94139 (Family Correlated)

Total Light Output, 3700K, 80 CRI (Lumens) - 4' Luminaire

H ¹	V
2680	3446

Light Output, 3700K, 80 CRI (Lumens Per Foot)

H ¹	V
670	862

Single Mode Power, 3700K (Watts Per Foot)

H ¹	V
6.8	8.8

Dual Mode Power, 3700K (Watts Per Foot)

H ¹			V		
Occupied	LPD	Unoccupied	Occupied	LPD	Unoccupied
6.9	5.4	4.1	9.0	7.0	5.2

Efficacy, 3700K, 80 CRI (Lumens Per Watt)

H ¹	V
99	98

¹ Family Correlation based on 4' luminaire 3700K Very High Output (V) test - 120V.
H - High Output, V - Very High Output

Wattage is Real Power. If you would like additional details to calculate Apparent Power, please contact your local Finelite representative.

- Use **Occupied Power** for total electrical load calculations. Use this value to estimate branch circuit lighting loads.
- Use **LPD Power** for lighting power density calculations. Only the power attributed to white light is required per NEMA LSD EB 84-202X. Power used toward germicidal disinfection has been removed for this calculation.
- Use **Unoccupied** and **Occupied Power** for energy calculations to determine the power consumed over time based on the use of the space.

Sample Lumen Adjustment Calculation

Lumen Adjustment Factors 80 CRI	
Indigo-Clean	
3200K	0.98
3700K	1.00
4300K	1.03

FLUSH: Very High Output (V), 3200K, 80 CRI
Lumen Adjustment Factor: 0.98
Total Light Output: 3446 lm x 0.98 = 3377 lm
Total Light Output per Foot: 862 lm/ft x 0.98 = 845 lm/ft.
watts/foot: 8.8 W/ft.
Efficacy = $\frac{845 \frac{\text{lm}}{\text{ft}}}{8.8 \frac{\text{W}}{\text{ft}}}$ = 96 lm/W

Protected by one or more US Patents: 8915613; D702,391; D702,390; D700,732

Submitted by:		Date:
Type:	Project:	
Ordering Info:		

Indigo Clean Dual Mode - Basic Wiring Diagram

WIRING DIAGRAM

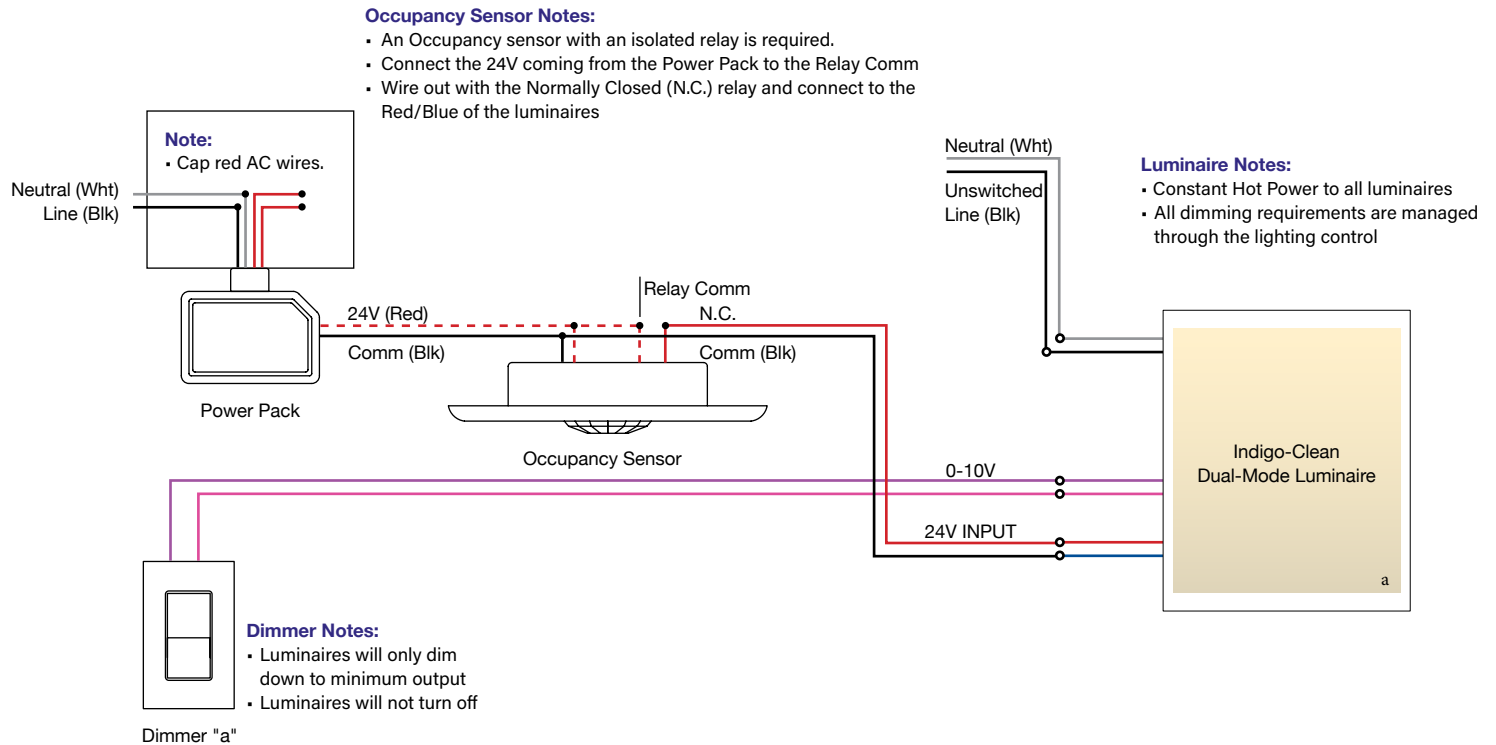

DUAL FEED DETAIL

CONTROL FEED

Blue / Red
Blue / Black

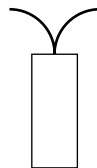

24V Dual Mode Control Pair

Each Indigo-Clean Dual Mode fixture will have a pair of #18awg low voltage wires

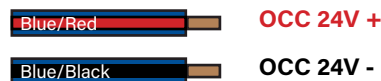

POWER FEED

Black, White, Green,
Purple, Pink

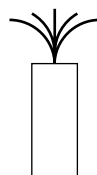

WIRING LEGEND	
Black	Hot
White	Neutral
Green	Ground
Purple	0-10V +
Pink	0-10V -