

Submitted by:		Date:
Type:	Project:	
Ordering Info:		

High Performance 2" Aperture (HP-2) Recessed

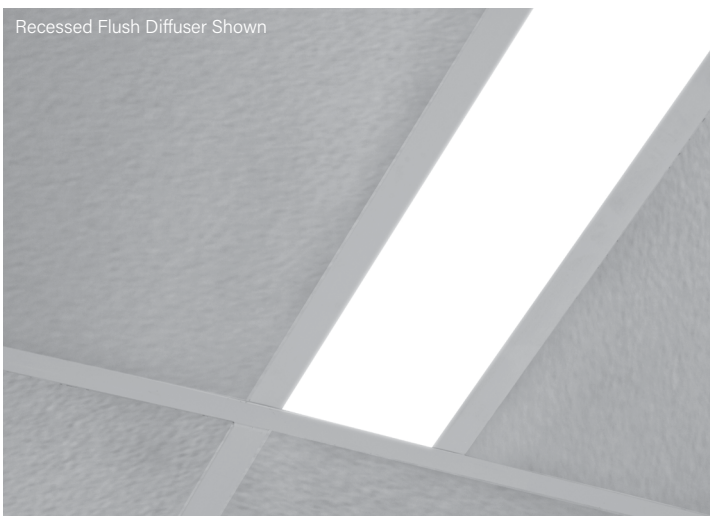

Indigo-Clean Technology is a Continuous Environmental Disinfection System that emits a narrow spectrum light that kills bacteria, Influenza-A¹, and SARS-CoV-2 – the virus that causes COVID-19¹ – and is proven effective by recently conducted independent lab testing. Unlike UV disinfection, Indigo-Clean Technology is designed to safely and continuously disinfect a space while it is fully occupied.

Single-Mode Indigo-Clean Technology utilizes a combination of blended white LEDs and 405nm LEDs on a single circuit board design. When the luminaires are on, the disinfection is active.

Dual-Mode Indigo-Clean Technology utilizes a mid-power of blended white LEDs and 405nm LEDs on a two circuit board design and full 405nm indigo light using automated controls to disinfect the space. When the space is unoccupied, it utilizes just the 405nm LEDs with increased output to increase disinfection efficacy.

These products are enrolled in the International Living Future Institute (ILFI) Declare 2.0 Program and is third-party verified with options achieving **Red List Approved** and **Red List Declared** status.

Note: see page 6 for all aesthetic options

CROSS SECTIONS

Recessed

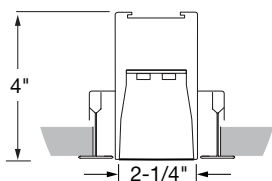

Flush Downlight Diffuser (standard)

Regressed

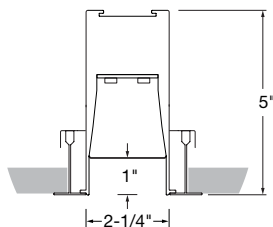

Flat Diffuser with 1" Regressed

OPTIC OPTIONS

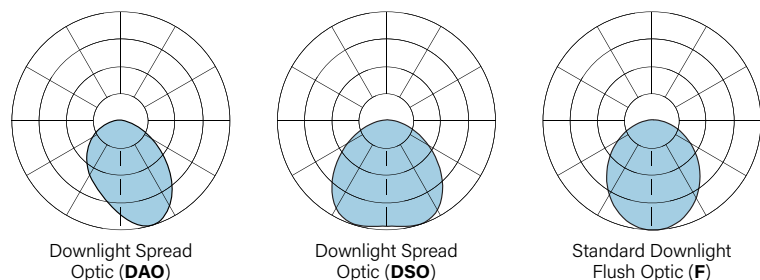

Downlight Spread Optic (DAO)

Downlight Spread Optic (DSO)

Standard Downlight Flush Optic (F)

ALSO AVAILABLE IN

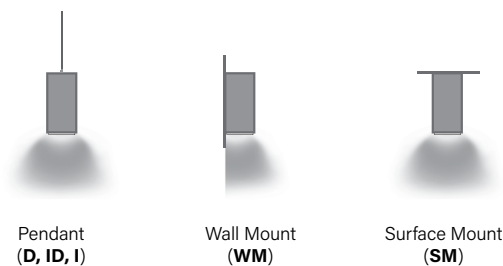

Pendant (D, ID, I)

Wall Mount (WM)

Surface Mount (SM)



Indigo-Clean is a registered trademark of Kenall Manufacturing Co., a Legrand Company

¹ Indigo-Clean Research Reports

Protected by one or more US Patents: 8915613; D702,391; D702,390; D700,732

Submitted by:		Date:
Type:	Project:	
Ordering Info:		

High Performance 2" Aperture (HP-2) Recessed

BODY TYPE

OUTPUT AND LED TYPE

Platform	Series Name	Luminaire Type	Luminaire Distribution	Total Length of Run	Downlight Output
HP - High Performance	2	R - Recessed R RG - Recessed Regressed ^{1,2} (Wall Wash not available)	D - Direct	Minimum 2' section length. Increments accurate to 1/16" (±1/32"), standard. 12' maximum section length.	H - High (606 lm/ft) V - Very High (780 lm/ft) TL - Tailored: _____lm/ft*

* Specify lm/ft of outputs between High (H) and Very High (V). Consult factory for tailored lumen output outside of this range.

OUTPUT AND LED TYPE

MECHANICAL/OPTICAL OPTIONS

ELECTRICAL OPTIONS

LED CRI/CCT	Downlight	Reflector System	Voltage	Circuiting ⁴
832-SMIC - 80 CRI, 3200K Single Mode Indigo-Clean 837-SMIC - 80 CRI, 3700K Single Mode Indigo-Clean 843-SMIC - 80 CRI, 4300K Single Mode Indigo-Clean 832-DMIC - 80 CRI, 3200K Dual Mode Indigo-Clean 837-DMIC - 80 CRI, 3700K Dual Mode Indigo-Clean 843-DMIC - 80 CRI, 4300K Dual Mode Indigo-Clean	F - Flush (standard) ¹ DL - 1" Drop Down Lens RG-D - Flat Diffuser with 1" Regress ² RG-WCB - White Cross Blade Baffle ² RG-LHE - Hollowed Ellipse Louver ² RG-LHC - Hex Louver ² DAO-L - Downlight Asymmetric Optic Left ³ DAO-R - Downlight Asymmetric Optic Right ³ DSO - Downlight Spread Optic ³	96LG - 96 Low Gloss White	120 - 120 Voltage 277 - 277 Voltage 347 - 347 Voltage	SC - Single Circuit* One single circuit in a run MC - Multi-Circuit* More than one switch leg or zone. Factory shop drawings required <small>* Battery, Night Light, and Emergency to Generator circuits are in addition to the normal luminaire circuit(s)</small>

ELECTRICAL OPTIONS

MOUNTING OPTIONS

OTHER OPTIONS

Driver Selection	Ceiling Hardware Type	Endcap Style	Finish
0-10V Driver Options FC-10% - 0-10V 10% (standard) FC-1% - 0-10V 1% OTi-10% - EldoLED OTi, 0-10V 10% ⁵ OTi-1% - EldoLED OTi, 0-10V 1% ⁵ ELD-10V-0% - EldoLED SOLOdrive, 0-10V 0.1% DALI Driver Options FC-DALI-1% - DALI 1% DXL-DALI-1% - EldoLED Dexal, 1% ELD-DALI-0% - EldoLED SOLOdrive, 0.1%	DMX Driver Options ELD-DMX - EldoLED POWERdrive, 0.1% Lutron Driver Options LUT-ES1 - Lutron, Ecosystem 1% See Page 3 for additional driver options and details	C1 - 15/16" T-Bar C1T - 15/16" Tegular C2 - 9/16" T-Bar C2T - 9/16" Tegular C3 - Screw Slot C3F - Flush Screw Slot SF - Spackle Flange VF - Visible Flange TZ4 - Tech Zone 4" (C1, C2, C2T, C3, C3F)	FE - Flat Endcap (standard) DE - 1" Drop Endcap SW - Signal White (standard) FB - Finelite Black SA - Satin Aluminum #### - RAL Color Code ⁶

Emergency Style (Optional) <small>See page 5 Backup Battery table</small>	Integrated Sensor (Optional) ⁷	Special Options (Optional)
LGD18W - Legrand 18W Brand Battery Back-up LGD10W - Legrand 10W Brand Battery Back-up EM/GEN - Emergency to Generator NL - Night Light BSL310LP - Bodine Battery Back up Low Profile GTD - Generator Transfer Device ALCR - Automatic Load Control Relay	OBO - Occupancy OBD - Daylight W601 - Wattstopper ⁸ Wireless Sensor OBE - Enlighted ⁹ REE - Remote Enlighted ¹⁰ CLM - Encelium Sensor RE7 - nLight Air Sensor <small>Integrated Sensor not available for Dual-Mode</small>	AOCC-W - Lutron Athena Sensor (Device Color White) ¹¹ AOCC-B - Lutron Athena Sensor (Device Color Black) ¹¹ ARF-W - Lutron Athena RF (Device Color White) ¹¹ ARF-B - Lutron Athena RF (Device Color Black) ¹¹ VOCC - Lutron Vive Sensor ¹² VRF - Lutron Vive RF ¹² CP - Chicago Plenum ¹³ FLX - Flex Whip RLA - Red List Approved RLD - Red List Declared

¹ Not available with Wall Wash

² Recessed Regressed straight run only

³ Not available with Regressed or Curves

⁴ Contact factory for switching options

⁵ Add DTO to gain "Dim to Off" functionality (FC-10% - DTO, FC-1% - DTO).

Not available with Dual-Mode.

⁶ 20 business days lead time for color

⁷ Minimum fixture length with a sensor is 3ft.

⁸ LMFS-601 w/ 0-10V driver(s) and LMFI-111, up to 6 drivers may be connected. LMFS-601 w/ DALI driver, only 1 driver can be connected.

⁹ Enlighted components installed by Finelite, provided by others

¹⁰ Enlighted Control Unit & Sensor Cable installed for Remote mounting sensor.

¹¹ 0-10V Drivers - **AOCC** up to 10 drivers may be connected; **ARF** up to 40 drivers may be connected

DALI Drivers - **AOCC** & **ARF** up to 4 drivers can be connected.

¹² Lutron Vive Ingrated Sensors require a DALI driver

¹³ Only available with C1, C2, and C3 mounting hardware with Finelite Gridbox

Submitted by:		Date:
Type:	Project:	
Ordering Info:		

High Performance 2" Aperture (HP-2) Recessed

SUPPLEMENTARY DRIVER PAGE

0-10V Driver Options

FC-10%	Factory Choice, 0-10V 10% Dimming (Linear)
FC-10%-DTO	Factory Choice, 0-10V 10% Dimming, Dim-to-Off (Linear)
FC-1%	Factory Choice, 0-10V 1% Dimming (Linear)
FC-1%-DTO	Factory Choice, 0-10V 1% Dimming, Dim-to-Off (Linear)
ELD-10V-0%	EldoLED SOLOdrive, 0-10V 0.1% Dimming (Linear)
ELD-10V-1%	EldoLED ECOdrive, 0-10V 1% Dimming (Linear)
OTi-10%	EldoLED OTi, 0-10V 10% Dimming (Linear)
OTi-10%-DTO	EldoLED OTi, 0-10V 10% Dimming, Dim-to-Off (Linear)
OTi-1%	EldoLED OTi, 0-10V 1% Dimming (Linear)
OTi-1%-DTO	EldoLED OTi, 0-10V 1% Dimming, Dim-to-Off (Linear)

DALI Driver Options

FC-DALI-1%	Factory Choice, DALI 1% Dimming (Logarithmic)
DXL-DALI-1%	EldoLED Dexal, DALI 1% Dimming (Logarithmic)
ELD-DALI-0%	EldoLED SOLOdrive, DALI 0.1% Dimming (Logarithmic)
ELD-DALI-1%	EldoLED ECOdrive, DALI 1% Dimming (Logarithmic)

DMX Driver Options

ELD-DMX	EldoLED POWERdrive, DMX 0.1% Dimming (8 Bit, 1CH) (Linear)
ELD-DMX-16	EldoLED POWERdrive, DMX 0.1% Dimming (16 Bit, 2CH) (Linear)

Lutron Driver Options

LUT-ES1	Lutron, Ecosystem 1% Dimming
----------------	------------------------------

Submitted by:		Date:
Type:	Project:	
Ordering Info:		

High Performance 2" Aperture (HP-2) Recessed

SPECIFICATIONS

BODY TYPE

CONSTRUCTION: Precision-cut 6061-T6 extruded aluminum body. Internal joiner system and plug-together wiring are standard.

LENGTHS: Any length, 2' minimum, in increments down to 1/16th" (±1/32"). 12' maximum section length. Hollowed Ellipse Louver (**LHE**), Hex Louver (**LHC**), and White Cross Blade Baffle (**WCB**) are available in 1' increments.

MITERED CORNERS: Illuminated corners of greater than 60° and less than 180° in a single plane, available with Flush Diffuser, Bottom Glow Diffuser, 1" Drop Down Lens, Regressed Diffuser, or White Cross Blade Baffle¹, Hollowed Ellipse Louver (**LHE**) or Hex Louver (**LHC**). Contact factory for Double miters using the White Cross Blade Baffle. Consult factory for tailored lighting options.

OUTPUT AND LED TYPE

LIGHT OUTPUT: Two lumen packages available, High (**H**), and Very High (**V**). For lengths 3' and greater, the uplight and downlight can be specified with different lumen packages and dual controls. For Tailored Outputs outside of range from High (**H**) to Very High (**V**), consult factory. Light engines are replaceable.

INDIGO-CLEAN TECHNOLOGY: Indigo-Clean Technology utilizes a combination of blended white LEDs, and safe 405nm LEDs to continually disinfect a space and kill bacteria, Influenza-A², and SARS-CoV-2 – the virus that causes COVID-19². Unlike UV disinfection, Indigo-Clean Technology is designed to safely and continuously disinfect a space while it is fully occupied. When the Indigo-Clean Technology light is on, disinfection is active. For optimum performance, continuously provide an average of 50-60 footcandles on the work plane and high touch surfaces (24/7). Dimming generally reduces effectiveness and increases the variation in the disinfecting light's visual appearance.

Single-Mode Indigo-Clean Technology: Continuous environmental disinfection system that uses a blended white LEDs and 405nm Indigo-Clean LEDs. The narrow spectrum light provides a safe visible light that disinfects the space. When the light is on, disinfection is active.

Dual-Mode Indigo-Clean Technology: Utilizes a two circuit board design. When the space is occupied it utilizes a combination of blended white LEDs and 405nm LEDs. When the space is unoccupied, it utilizes just the 405nm LEDs with increased output to increase disinfection efficacy. Dim to Off not available.

Dual-Mode Indigo-Clean Technology Controller: It is a low-voltage internal device that determines the operational mode based on the input received from the external automated controls. An Off manual push will not turn the lights off, but rather turn the lights to Blue Mode. Please refer to Dual-Mode Application Guide for wiring diagram.

MECHANICAL/OPTICAL OPTIONS

DOWNLIGHT OPTION: 12' maximum diffuser length. Flush frost white snap-in diffuser standard, 73% transmissive, 99% diffusion. Internal secondary diffusers at corners ensure visually seamless, uniform, continuous illumination. Available with Flush (**F**), Bottom Glow (**BG**), 1" Drop Down Lens (**DL**), White Cross Blade Baffle (**WCB**)^{3,4}, Ellipse Louver (**LHE**)³, Hex Louver (**LHC**)³, Downlight Asymmetric Optic (**DAO**)⁵, Downlight Spread Optic (**DSO**)⁵, and Regressed downlight diffusers (**RG**)³. 1" Drop Down Lens made of highly efficient acrylic. Available with a solid endcap or an endcap with a diffuse filler to continue the luminous aesthetic. Downlight Spread Optic and Downlight Asymmetric Optic are extruded lenses with a subtle ribbed appearance providing asymmetric or batwing distribution for improved optical performance. Consult factory for more tailored lumen outputs.

LUMEN MAINTENANCE: White LEDs: 90% of initial light output (L90) at 100,000+ hours; 70% of initial light output (L70) at 200,000+ hours. 405nm LEDs: 70% of initial output at L70 @ 60,000 hours.

REFLECTORS: Die-formed 20-gauge cold-rolled steel reflectors finished in 96LG High Reflectance white powder coat paint.

ELECTRICAL OPTIONS

STATIC WHITE FEED: Standard with one 18-gauge/5-conductor single-circuit feed wire controlling uplight and downlight together (power and dimming). Specify dual feed wires for independent control of uplight and downlight. 14-gauge feed wire used when luminaire current exceeds 5 amps.

STATIC WHITE DRIVER: Replaceable 120V, 277V, and 347V constant current reduction dimming driver standard. Can be wired dimming or non-dimming. 0-10V dimming controls with a range of 10%- 100% standard. Dimming to 1% available. Separate dimming for uplight and downlight available. Driver is fully accessible from below the ceiling.

- **Power Factor:** ≥ 0.9
- **Total Harmonic Distortion (THD):** <20%
- **Expected driver lifetime:** 100,000 hours

¹ White Cross Blade (WCB) baffles not available with custom angles. Available in 90 degrees only

² [Indigo-Clean Research Reports](#)

³ Recessed Regressed straight run only

⁴ White Cross Blade Baffle (WCB) currently not advisable for drywall

⁵ Not available with Regressed

Submitted by:		Date:
Type:	Project:	
Ordering Info:		

High Performance 2" Aperture (HP-2) Recessed

SPECIFICATIONS

LUTRON DRIVER OPTIONS:

- **LUT-ES1 (LDE1)** - (Hi-lume 1% EcoSystem with Soft-On, Fade-to-Black dimming (LDE1 series))

MOUNTING OPTIONS

HANGING HARDWARE:

- **Recessed T-Bar:** Standard bracket design works with most lay-in ceiling types. Brackets secure luminaire to the ceiling grid from above. Tie-in T-Bar brackets connect the luminaire to the T-Bar for securing to structure. Consult local codes for tie-wire recommendations.
- **Recessed Spackle Flange:** Drywall surfaces (walls or ceilings): 1/4" - 20 stud and nut (provided by others). Mounted with three equidistant suspension points.

OTHER OPTIONS

ENDCAPS: Flat endcaps (**FE**) at each end of run add 1/16" to each end of luminaire. Drop Down Lens Illuminated Endcap (**DE**) includes diffuse element to continue luminance of drop lens.

EMERGENCY STYLE: Optional emergency to generator/inverter wiring, internal generator transfer switch, nightlight wiring, step-dimming driver, backup battery.

Backup Battery		
	Legrand 18W	Legrand 10W/ Bodine BSL310LP
HP2-R-D		
Min. Housing Length	8' [*]	4' ^{**}
EM Lumen Output	1560	929
EM Section Illuminated	2'	2' or 4'

Based on 3700K and 80-CRI

^{*} Minimum fixture housing length for battery pack approved without sensor

^{**} Exception: 5' not available, 6'+ okay.

Bodine GTD and Legrand ALCR Min. Length	
Configuration	Min Length
Generator	6'
Generator + OCC	8'
Day	6'
Generator + Day	8'

INTEGRATED SENSORS: Integrated PIR (Passive Infrared) Occupancy (**OBO**) or Daylight Sensors (**OBD**) available with Flush and Bottom Glow downlight diffusers. PIR sensors not recommended for stairwell applications. Refer to Occupancy Sensor & Daylight Sensor tech sheet and the Embedded Intelligence landing page for more information and additional sensor options. Minimum fixture length with a sensor is 3ft.

PATENT: Indigo-Clean products and technology covered by U.S. Patent No.US 9,039,966 and US 8,398,264. Product may also be covered by patents found at www.kenall.com/patents.

FINISHES: Finelite Signal White (**SW**) powder coat, Finelite Black (RAL 9005) with semi gloss fine texture (**FB**), and Satin Aluminum (**SA**) are standard. Optional Adder: 179 RAL colors[®] are available.

LABELS: Luminaire and electrical components are ETL-listed conforming to UL 1598 in the U.S.A. and CAN/CSA C22.2 No. 250.0 in Canada. In accordance with NEC Code 410.130 (G), this luminaire contains an internal driver disconnect. UL 924 and UL 2108 - PoE options available on request. EPA Est.No. 99530-CA-1, -2, -3. These fixtures are rated for Damp Location, IC Rated. Finelite products use electronic components that are RoHS compliant, and the mechanical components of the luminaire have been verified to not knowingly contain any restricted substances listed per RoHS Directive 2015/863. Consult factory for tailored lighting options. Finelite makes the specification process easy when putting healthier products on your projects. Simply add - **RLA** (Red List Approved) or - **RLD** (Red List Declared) to your part number.

WEIGHT: R - 2.3 lb/ft; WW-R - 2.9 lb/ft

WARRANTY: 5-year performance-based warranty on all standard components. Optional accessories such as emergency battery packs are covered by their individual manufacturer warranties.

⁶ 20 business days lead time for color

⁷ Excludes Battery Backup and Generator Transfer Device weight

Submitted by:		Date:
Type:	Project:	
Ordering Info:		

High Performance 2" Aperture (HP-2) Recessed

AESTHETIC OPTIONS

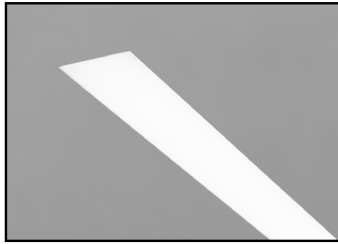

Flush Diffuser (F)

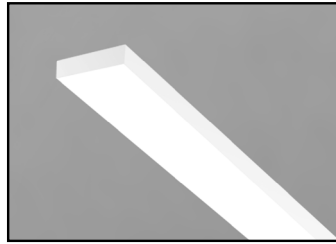

1" Drop Down Lens (DL)

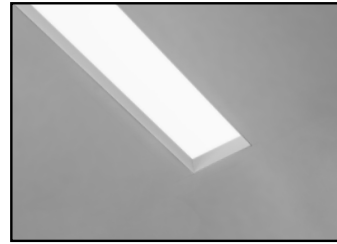

Flat Diffuser with 1" Regressed (RG-D)

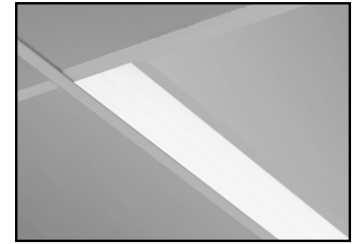

Downlight Asymmetric Optic (DAO)¹
Externally flush

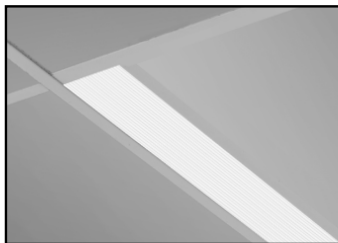

Downlight Spread Optic (DSO)¹
Externally flush

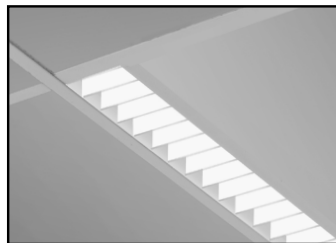

White Cross Blade Baffle² (RG-WCB)

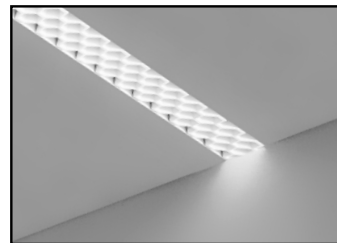

Hex Louver² (RG-LHC)

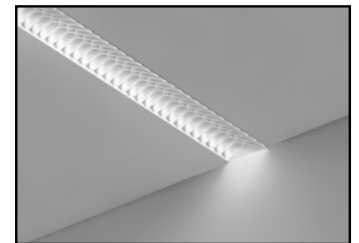

Hollowed Ellipse Louver² (RG-LHE)

¹ With a subtle ribbed appearance providing an asymmetric or batwing distribution
² Regressed only

DOWNLIGHT ASYMMETRIC OPTIONS

Use this tool to understand how to specify Downlight Asymmetric for your project. The diagrams below show a linear run from power feed to ender. Specify DAO-L distributes light to the left or DAO-R distributes light to the right.

PREINSTALLED LABEL

For DAO, Preinstalled label on diffuser shows direction of light. Remove after installation.

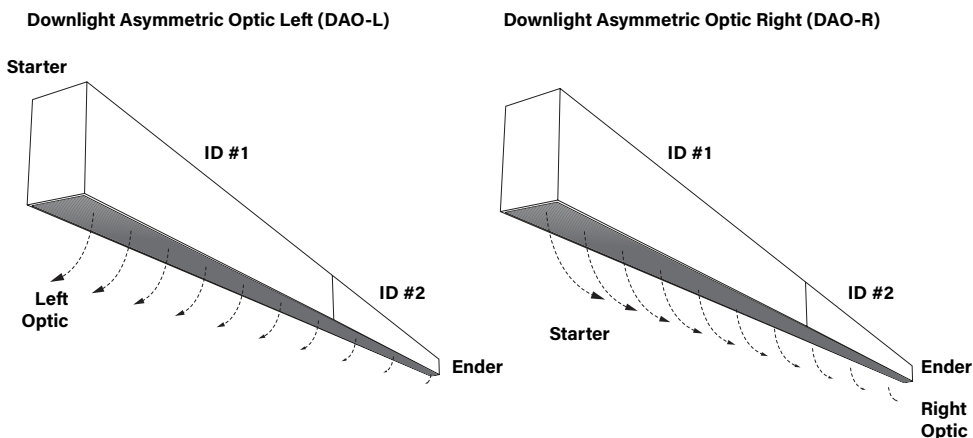

Submitted by:		Date:
Type:	Project:	
Ordering Info:		

High Performance 2" Aperture (HP-2) Recessed

HARD CEILING MOUNTING OPTIONS

Threaded Rod Option

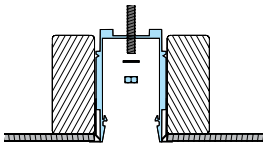

Screw Mount Option

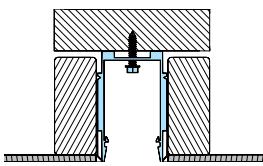

Mounting Location for Securing to Structure

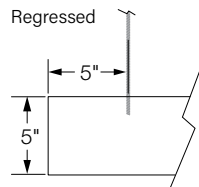
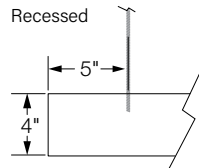

Two mounting options: threaded rod and screw mounting options. Mounting locations are located on each end of the luminaire. Mounting location is 5" away from each end of luminaire.

T-BAR INSTALLATION

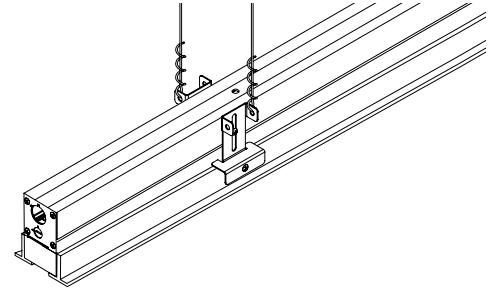

HP-2 R for T-Bar installations comes standard with a splice plate at the end of the luminaire. Mounting brackets (supplied) secure the luminaire to T-Bar and provide support to structure location. All even foot length (2, 4, 6, ...) luminaire runs are reduced in length by an appropriate amount to fit within typical 2x2 and 2x4 T-Bar grid systems. For uncommon T-Bar systems please consult factory.

GRID LENGTH DETAIL - 4' EXAMPLE

1" T-Bar

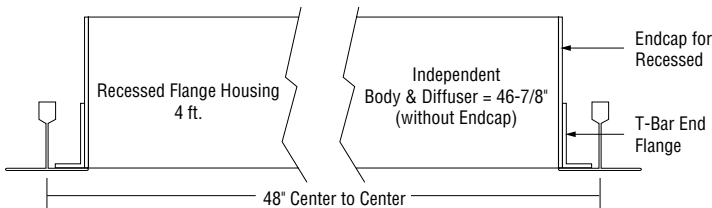

9/16" T-Bar

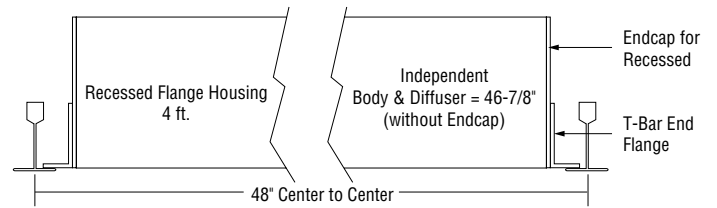

9/16" Screw Slot

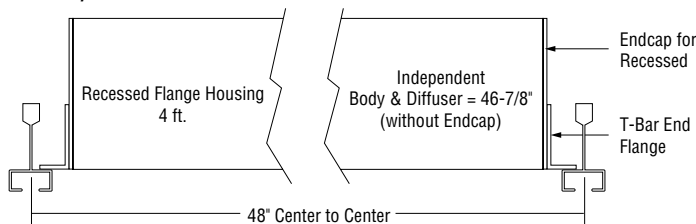

HARD CEILING LENGTH DETAIL - 4' EXAMPLE

Spackle Flange

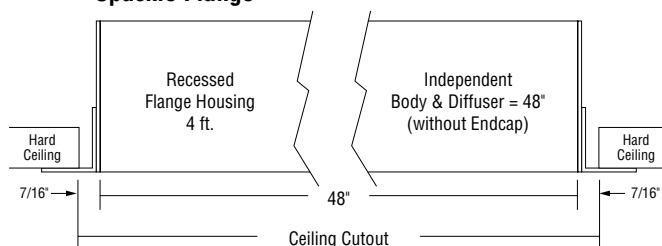

Visible Flange

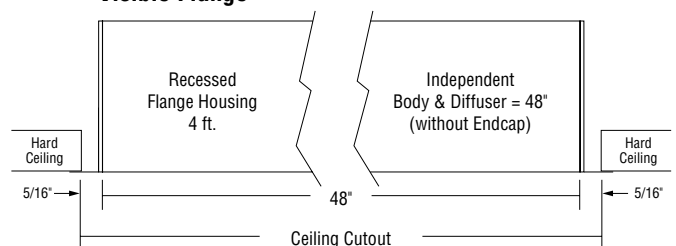

Submitted by:		Date:
Type:	Project:	
Ordering Info:		

High Performance 2" Aperture (HP-2) Recessed

RECESSED MOUNTING TYPES - T-BAR

Rough-In Dimensions

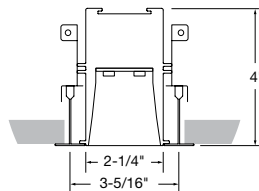

15/16" T-Bar (C1)

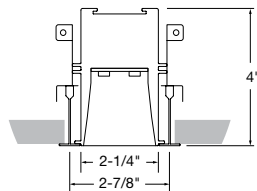

9/16" T-Bar (C2)

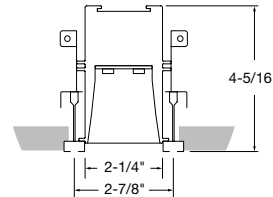

Standard Screw Slot (C3)

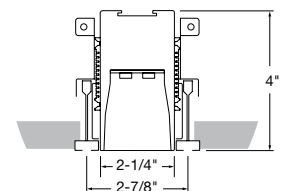

Flush Screw Slot (C3F)

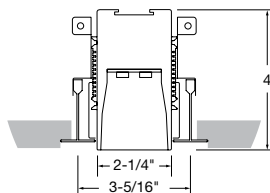

15/16" Tegular (C1T)

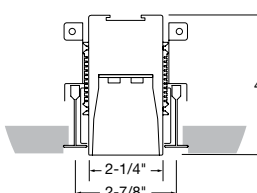

9/16" Tegular (C2T)

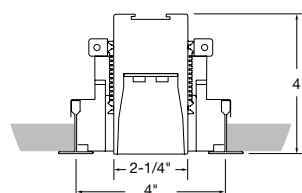

Tech Zone 4" (TZ4)
15/16" T-Bar (C1)

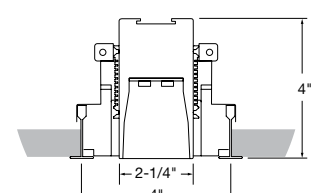

Tech Zone 4" (TZ4)
9/16" T-Bar (C2)

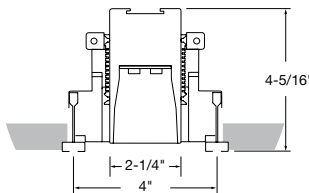

Tech Zone 4" (TZ4)
Standard Screw Slot (C3)

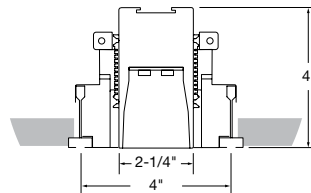

Tech Zone 4" (TZ4)
Flush Screw Slot (C3F)

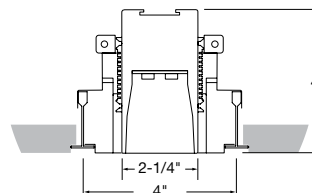

Tech Zone 4" (TZ4)
9/16" Tegular (C2T)

RECESSED MOUNTING TYPES - CUTOUT DIMENSIONS

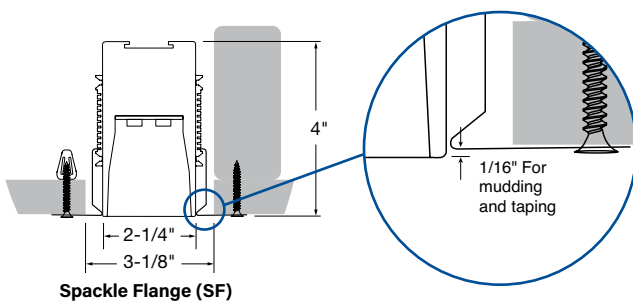

Spackle Flange (SF)

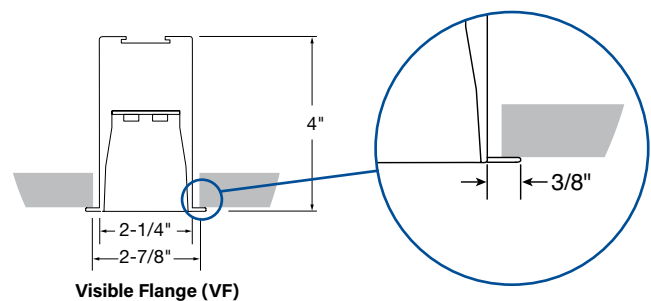

Visible Flange (VF)

HOUSING

Version 1

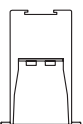

Ceiling Option VF

Version 2

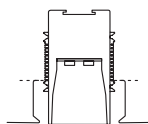

Ceiling Options
C1T, C2T, C3F, SF, TZ4

Version 3

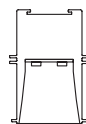

Ceiling Options
C1, C2, C3

Note: +/- 1/16"

Protected by one or more US Patents: 8915613; D702,391; D702,390; D700,732

Page 8

Submitted by:		Date:
Type:	Project:	
Ordering Info:		

High Performance 2" Aperture (HP-2) Recessed

REGRESSED MOUNTING TYPES - T-BAR

Rough-In Dimensions

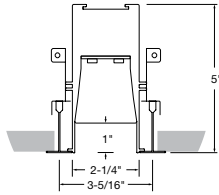

15/16" T-Bar (C1)

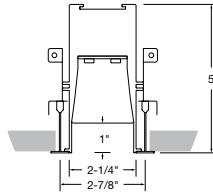

9/16" T-Bar (C2)

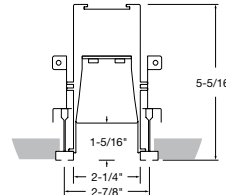

Standard Screw Slot (C3)

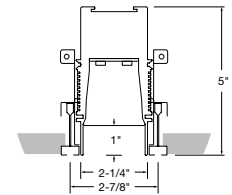

Flush Screw Slot (C3F)

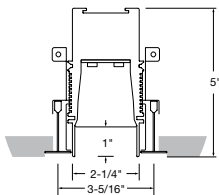

15/16" Tegular (C1T)

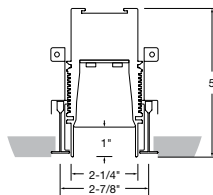

9/16" Tegular (C2T)

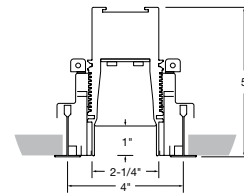

Tech Zone 4" (TZ4)
15/16" T-Bar (C1)

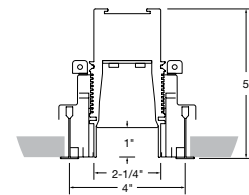

Tech Zone 4" (TZ4)
9/16" T-Bar (C2)

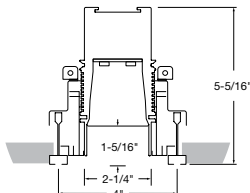

Tech Zone 4" (TZ4)
Standard Screw Slot (C3)

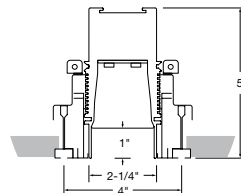

Tech Zone 4" (TZ4)
Flush Screw Slot (C3F)

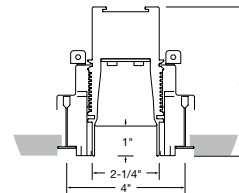

Tech Zone 4" (TZ4)
9/16" Tegular (C2T)

REGRESSED MOUNTING TYPES - CUTOUT DIMENSIONS

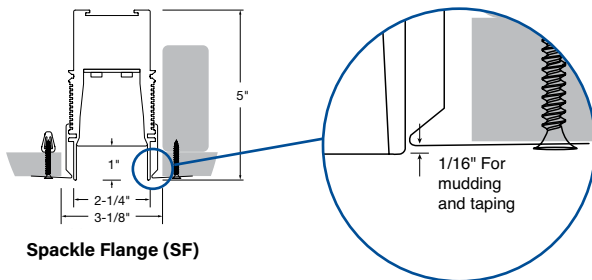

Spackle Flange (SF)

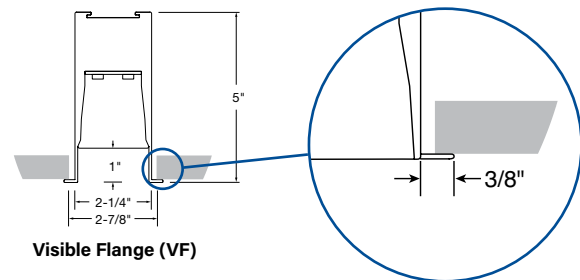

Visible Flange (VF)

Regressed Lens: Regressed lens version is 5" tall with a lens that is regressed 1" from ceiling line.

HOUSING

Version 1

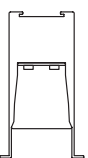

Ceiling Option VF

Version 2

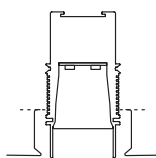

Ceiling Options
C1T, C2T, C3F, SF, TZ4

Version 3

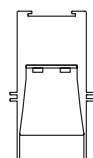

Ceiling Options
C1, C2, C3

Note: +/- 1/16"

Protected by one or more US Patents: 8915613; D702,391; D702,390; D700,732

Submitted by:		Date:
Type:	Project:	
Ordering Info:		

High Performance 2" Aperture (HP-2) Recessed

Direct Photometry - 4' Luminaire 3700K

HP2-P-R-4'-V-837-SMIC-DSO

Downlight: Downlight Spread Optic

Efficacy: 91 lm/W

Total luminaire output: 3175 lumens (794 lm/ft)
35 watts (8.8 W/ft)

Peak Candela Value: 1161 @ 15°

CRI: 80 / CCT: 3700K

ITL LM79 Report 94139 (Family Correlated)

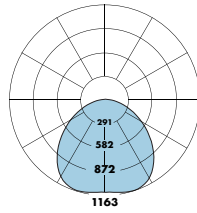

CANDELA DISTRIBUTION

	0.0	22.5	45.0	67.5	90.0	FLUX
0	1131	1131	1131	1131	1131	
5	1123	1124	1129	1134	1136	108
15	1060	1070	1116	1151	1161	314
25	942	972	1063	1121	1135	483
35	790	840	955	1005	1011	578
45	625	682	790	817	811	579
55	461	509	590	598	590	497
65	305	338	386	385	375	359
75	166	179	202	197	191	201
85	49	50	51	49	47	57
90	0	0	0	0	0	

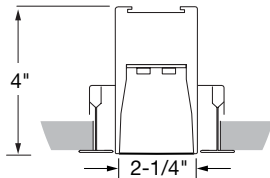

Direct Photometry - 4' Luminaire 3700K

HP2-P-R-V-837-SMIC-F

Downlight: Flush Diffuser

Efficacy: 89 lm/W

Total luminaire output: 3119 lumens (780 lm/ft)
35 watts (8.8 W/ft)

Peak Candela Value: 1294 @ 0°

CRI: 80 / CCT: 3700K

ITL LM79 Report 85136 (Family Correlated)

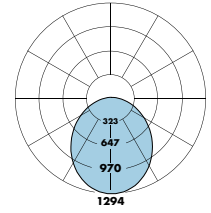

CANDELA DISTRIBUTION

	0.0	22.5	45.0	67.5	90.0	FLUX
0	1294	1294	1294	1294	1294	
5	1287	1286	1286	1285	1284	122
15	1225	1214	1213	1207	1199	341
25	1099	1084	1076	1055	1043	493
35	929	914	895	869	860	559
45	739	725	703	676	665	542
55	546	534	516	494	485	460
65	363	354	340	327	321	339
75	200	195	189	182	179	200
85	60	59	57	55	55	64
90	0	0	0	0	0	

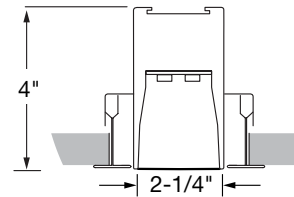

Information in chart below is for reference and based on ITL LM79 report 94139 (Family Correlated)

Total Light Output, 3700K, 80 CRI (Lumens) - 4' Luminaire

H ¹	V
2469	3175

Light Output, 3700K, 80 CRI (Lumens Per Foot)

H ¹	V
617	794

Single Mode Power, 3700K (Watts Per Foot)

H ¹	V
6.7	8.8

Dual Mode Power, 3700K (Watts Per Foot)

H ¹			V		
Occupied	LPD	Unoccupied	Occupied	LPD	Unoccupied
6.9	5.5	4.1	9.0	7.1	5.2

Efficacy, 3700K, 80 CRI (Lumens Per Watt)

H ¹	V
92	91

1 Family Correlation based on 4' luminaire 3700K Very High Output (V) test - 120V.
H - High Output, V - Very High Output

Information in chart below is for reference and based on ITL LM79 report 94139 (Family Correlated)

Total Light Output, 3700K, 80 CRI (Lumens) - 4' Luminaire

H ¹	V
2426	3119

Light Output, 3700K, 80 CRI (Lumens Per Foot)

H ¹	V
606	780

Single Mode Power, 3700K (Watts Per Foot)

H ¹	V
6.7	8.8

Dual Mode Power, 3700K (Watts Per Foot)

H ¹			V		
Occupied	LPD	Unoccupied	Occupied	LPD	Unoccupied
6.9	5.5	4.1	9.0	7.1	5.2

Efficacy, 3700K, 80 CRI (Lumens Per Watt)

H ¹	V
90	89

1 Family Correlation based on 4' luminaire 3700K Very High Output (V) test - 120V.
H - High Output, V - Very High Output

Wattage is Real Power. If you would like additional details to calculate Apparent Power, please contact your local Finelite representative.

- Use **Occupied Power** for total electrical load calculations. Use this value to estimate branch circuit lighting loads.
- Use **LPD Power** for lighting power density calculations. Only the power attributed to white light is required per NEMA LSD EB 84-202X. Power used toward germicidal disinfection has been removed for this calculation.
- Use **Unoccupied** and **Occupied Power** for energy calculations to determine the power consumed over time based on the use of the space.

Sample Lumen Adjustment Calculation

Lumen Adjustment Factors 80 CRI	
Indigo-Clean	
3200K	0.98
3700K	1.00
4300K	1.03

FLUSH - Very High Output (V), 3200K, 80 CRI
Lumen Adjustment Factor: 0.98
Total Light Output: 3119 lm x 0.98 = 3057 lm
Total Light Output per Foot: 780 lm/ft x 0.98 = 764 lm/ft.
watts/foot: 8.8 W/ft.
Efficacy = $\frac{764 \frac{\text{lm}}{\text{ft.}}}{8.8 \frac{\text{W}}{\text{ft.}}} = 87 \text{ lm/W}$

Submitted by:		Date:
Type:	Project:	
Ordering Info:		

Indigo Clean Dual Mode - Basic Wiring Diagram

WIRING DIAGRAM

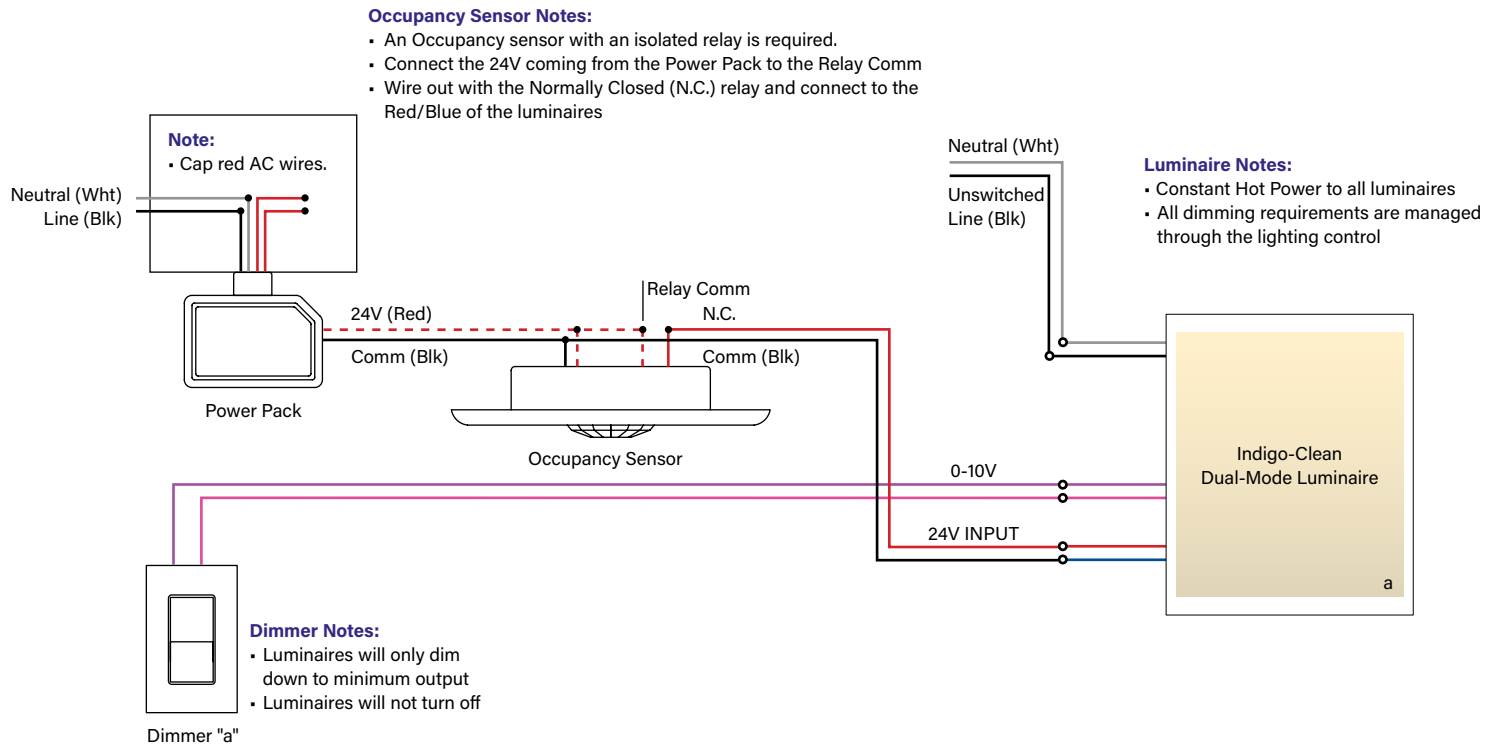

DUAL FEED DETAIL

CONTROL FEED
Blue / Red
Blue / Black

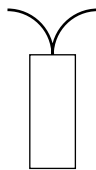

24V Dual Mode Control Pair

Each Indigo-Clean Dual Mode fixture will have a pair of #18awg low voltage wires

WIRING LEGEND	
Blue/Red	OCC 24V +
Blue/Black	OCC 24V -



Blue w/ a Red stripe (24V +)
Blue with a Black stripe wire (COMMON)

POWER FEED
Black, White, Green,
Purple, Pink

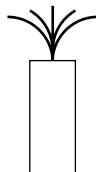

WIRING LEGEND	
Black	Hot
White	Neutral
Green	Ground
Purple	0-10V +
Pink	0-10V -