

Submitted by:		Date:
Type:	Project:	
Ordering Info:		

High Performance 6" Aperture (HP-6) Recessed

Recessed Flush Diffuser - Hard Ceiling Shown

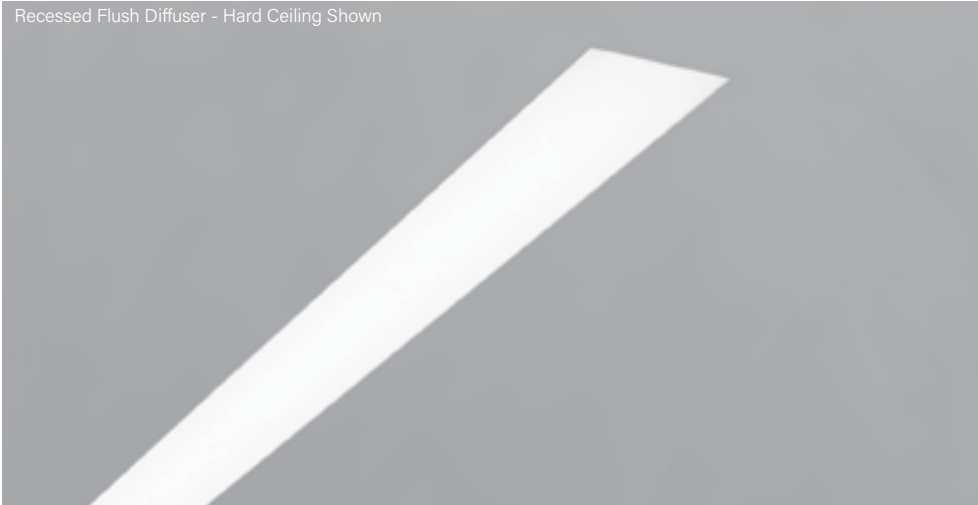

High Performance 6" Aperture is a patented, linear LED luminaire family. HP-6 delivers excellent performance using an advanced optical design and mid-power LEDs. Achieving 90% of initial light output at 100,000+ hours and backed by a 10-year performance-based warranty on all standard components.

This product is enrolled in the International Living Future Institute (ILFI) Declare 2.0 Program and is third-party verified with options achieving **Red List Approved** and **Red List Declared** status.

Note: see page 6 for all aesthetic options

CROSS SECTIONS

Recessed Direct

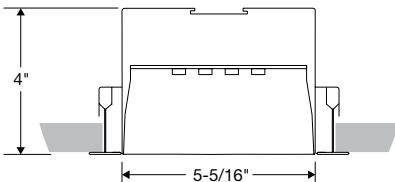

Flush Downlight Diffuser
(standard)

Recessed Enhanced Output Direct

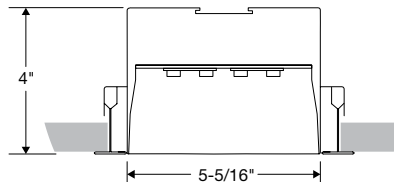

Flush Downlight Diffuser
(standard)

Recessed Direct with Air Return

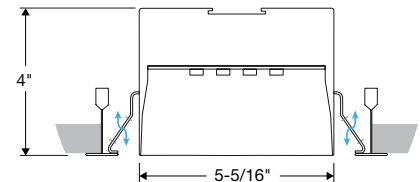

Flush Downlight Diffuser
(standard)

GET MORE WITH TAILORED LIGHTING

- Tailored Length
- Tailored Angle
- Tailored Color
- Tailored Output
- Tailored Control

ALSO AVAILABLE IN



Submitted by:		Date:
Type:	Project:	
Ordering Info:		

High Performance 6" Aperture (HP-6) Recessed

Ordering Guide Example: HP - 6 - R - D - 36' - S - 835 - F - 96LG - 120 - SC - FC-10% - C1 - FE - SW - LGD18W - OBO - CP - AR

BODY TYPE				OUTPUT AND LED TYPE		
Platform	Series Name	Luminaire Type	Luminaire Distribution	Total Length of Run	Light Output (Flush)	
HP - High Performance	6 6EO - Enhanced Output	R - Recessed	D - Direct	Minimum 2' section length. Increments accurate to 1/16" (±1/32"), standard. 12' maximum section length.	D Output S - Standard (386 lm/ft) B - Boosted (485 lm/ft) H - High (733 lm/ft) V - Very High (942 lm/ft) TL - Tailored: _____ lm/ft*	EO D Output H - High (1561 lm/ft) V - Very High (2007 lm/ft) X - Extremely High (2271 lm/ft) TL - Tailored: _____ lm/ft*

* Specify lm/ft of outputs between Standard (S) and Very High (V). Consult factory for tailored lumen output outside of this range.

OUTPUT AND LED TYPE		MECHANICAL OPTIONS		ELECTRICAL OPTIONS	
LED CRI/CCT	Downlight	Reflector System	Voltage	Circuiting ¹	
830 - 80 CRI, 3000K 835 - 80 CRI, 3500K 840 - 80 CRI, 4000K 930 - 90 CRI, 3000K 935 - 90 CRI, 3500K 940 - 90 CRI, 4000K 8TW - 80 CRI, Tunable White 9TW - 90 CRI, Tunable White	F - Flush (standard)	96LG - 96 Low Gloss White	120 - 120 Voltage 277 - 277 Voltage 347 - 347 Voltage	SC - Single Circuit* One single circuit in a run MC - Multi-Circuit* More than one switch leg or zone. Factory shop drawings required	

¹ Battery, Night Light, and Emergency to Generator circuits are in addition to the normal luminaire circuit(s)

ELECTRICAL OPTIONS		MOUNTING OPTIONS	
Driver Selection		Ceiling Hardware Type	
0-10V Driver Options FC-10% - 0-10V 10% (standard) FC-1% - 0-10V 1% OTi-10% - EldoLED OTi, 0-10V 10% ² OTi-1% - EldoLED OTi, 0-10V 1% ² ELD-10V-0% - EldoLED SOLOdrive, 0-10V 0.1% 10V-TW-10% - EldoLED OTi, 0-10V 10% (Tunable White) ² DALI Driver Options FC-DALI-1% - DALI 1% DXL-DALI-1% - EldoLED Dexal, 1% ELD-DALI-0% - EldoLED SOLOdrive, 0.1% ELD-DALI-TW - EldoLED DUALdrive LightShape, 0.1% (Tunable White)	Lutron Driver Options LUT-ES1 - Lutron, Ecosystem 1% LUT-TW - Lutron T-Series, EcoSystem 0.1% (Tunable White)	C1 - 15/16" T-Bar C1T - 15/16" Tegular C2 - 9/16" T-Bar C2T - 9/16" Tegular C3 - Screw Slot C3F - Flush Screw Slot SF - Spackle Flange VF - Visible Flange TZ6 - Tech Zone 6" _____ (C2, C2T, C3, C3F)	

See Page 3 for additional driver options and details

OTHER OPTIONS			
Endcap Style	Finish	Emergency Style (Optional) <small>See page 5 Backup Battery table</small>	
FE - Flat Endcap (standard)	SW - Signal White (standard) FB - Finelite Black SA - Satin Aluminum #### - RAL Color Code ⁴ _____	LGD18W - Legrand 18W Brand Battery Back-up LGD10W - Legrand 10W Brand Battery Back-up EM/GEN - Emergency to Generator NL - Night Light	BSL722 - Bodine Battery Back up BSL310LP - Bodine Battery Back up Low Profile GTD - Generator Transfer Device ALCR - Automatic Load Control Relay

OTHER OPTIONS		
Integrated Sensor (Optional)	Special Options (Optional)	Air Returnz (Optional)
OBO - Occupancy OBD - Daylight W601 - Wattstopper Wireless Sensor ⁵ OBE - Enlighted ⁶ CLM-99 - Encelium RF SLM-99 - Encelium Sensor	AOCC-W - Lutron Athena Sensor (Device Color White) ⁷ AOCC-B - Lutron Athena Sensor (Device Color Black) ⁷ ARF-W - Lutron Athena RF (Device Color White) ⁷ ARF-B - Lutron Athena RF (Device Color Black) ⁷ VOCC - Lutron Vive Wireless Sensor (VDO) ⁸ VRF - Lutron Vive Radio Only ⁸	CP - Chicago Plenum FLX - Flex Whip RLA - Red List Approved RLD - Red List Declared

¹ Contact factory for switching options
² Add DTO to gain "Dim to Off" functionality (FC-10% - DTO, FC-1% - DTO)
³ B & V outputs only
⁴ 20 business days lead time for color
⁵ LMFS-601 w/ 0-10V driver(s) and LMFI-111, up to 6 drivers may be connected.
⁶ LMFS-601 w/ Dali driver, only 1 driver can be connected.
⁷ 0-10V Drivers - **AOCC** up to 10 drivers may be connected; **ARF** up to 40 drivers may be connected
 DALI Drivers - **AOCC** & **ARF** up to 4 drivers can be connected.
⁸ Lutron Vive Integrated Sensors require a DALI driver

Submitted by:		Date:
Type:	Project:	
Ordering Info:		

High Performance 6" Aperture (HP-6) Recessed

SUPPLEMENTARY DRIVER PAGE

0-10V Driver Options

FC-10%	Factory Choice, 0-10V 10% Dimming (Linear)
FC-10%-DTO	Factory Choice, 0-10V 10% Dimming, Dim-to-Off (Linear)
FC-1%	Factory Choice, 0-10V 1% Dimming (Linear)
FC-1%-DTO	Factory Choice, 0-10V 1% Dimming, Dim-to-Off (Linear)
ELD-10V-0%	EldoLED SOLOdrive, 0-10V 0.1% Dimming (Linear)
ELD-10V-1%	EldoLED ECOdrive, 0-10V 1% Dimming (Linear)
10V-TW-10%	EldoLED OTi, 0-10V 10% Dimming, <i>Tunable White</i> (Linear)
10V-TW-10%-DTO	EldoLED OTi, 0-10V 10% Dimming, Dim-to-Off, <i>Tunable White</i> (Linear)
OTi-10%	EldoLED OTi, 0-10V 10% Dimming (Linear)
OTi-10%-DTO	EldoLED OTi, 0-10V 10% Dimming, Dim-to-Off (Linear)
OTi-1%	EldoLED OTi, 0-10V 1% Dimming (Linear)
OTi-1%-DTO	EldoLED OTi, 0-10V 1% Dimming, Dim-to-Off (Linear)

DALI Driver Options

FC-DALI-1%	Factory Choice, DALI 1% Dimming (Logarithmic)
DXL-DALI-1%	EldoLED Dexal, DALI 1% Dimming (Logarithmic)
ELD-DALI-0%	EldoLED SOLOdrive, DALI 0.1% Dimming (Logarithmic)
ELD-DALI-1%	EldoLED ECOdrive, DALI 1% Dimming (Logarithmic)
ELD-DALI-TW	EldoLED DUALdrive Light Shape, DALI 0.1% Dimming, <i>Tunable White</i> (Logarithmic Dimming, Linear CCT Control)

Lutron Driver Options

LUT-ES1	Lutron, Ecosystem 1% Dimming
LUT-TW	Lutron T-Series, EcoSystem 0.1% Dimming, <i>Tunable White</i>

Submitted by:		Date:
Type:	Project:	
Ordering Info:		

High Performance 6" Aperture (HP-6) Recessed

SPECIFICATIONS

BODY TYPE

CONSTRUCTION: Precision-cut 6063-T6 extruded aluminum body. Internal joiner system, plug-together wiring, standard.

LENGTHS: Any length, 2' minimum, in increments down to 1/16" ($\pm 1/32"$). 12' maximum section length.

MITERED CORNERS: Fully illuminated 90° corners have double-diffusers to ensure against light leaks. Custom angles are available (90° minimum on inside corners.) Consult factory for tailored lighting options.

OUTPUT AND LED TYPE

LIGHT OUTPUT: Lumen packages available for **HP-6 D:** Standard (**S**), Boosted Standard (**B**), High (**H**), and Very High (**V**). **HP-6 EO D:** High (**H**), Very High (**V**), and Extremely High (**X**). For Tailored Outputs outside of range from Standard (**S**) to Very High (**V**), consult factory. Light engines are replaceable.

MECHANICAL/OPTICAL OPTIONS

DOWNLIGHT OPTION: 12' maximum diffuser length. Flush frost white snap-in diffuser standard, 73% transmissive, 99% diffusion. Internal secondary diffusers at corners ensure visually seamless, uniform, continuous illumination. Available with Flush (**F**) downlight diffuser. Consult factory for more tailored lumen outputs.

LUMEN MAINTENANCE: 90% of initial light output (L90) at 100,000+ hours; 70% of initial light output (L70) at 200,000+ hours.

REFLECTORS: Die-formed 20-gauge cold-rolled steel reflectors finished in 96LG High Reflectance white powder coat paint.

ELECTRICAL OPTIONS

STATIC WHITE FEED: Standard with one 18-gauge/5-conductor single-circuit feed wire. 14-gauge feed wire used when luminaire current exceeds 5 amps.

TUNABLE WHITE FEED: Standard with one 18-gauge/5-conductor single-circuit feed. 14-gauge feed used when luminaire current exceeds 5 amps.

STATIC WHITE DRIVER: Replaceable 120V, 277V, and 347V constant current reduction dimming driver standard. Can be wired dimming or non-dimming. 0-10V dimming controls with a range of 10%- 100% standard. Dimming to 1% available. Driver is fully accessible from below the ceiling.

- **Power Factor:** ≥ 0.9
- **Total Harmonic Distortion (THD):** $< 20\%$
- **Expected driver lifetime:** 100,000 hours

LUTRON DRIVER OPTIONS:

- **LUT-ES1 (LDE1)** - (Hi-lume 1% EcoSystem with Soft-On, Fade-to-Black dimming (LDE1 series))

TUNABLE WHITE DRIVER: Replaceable LED driver. Driver is accessible from below the ceiling. 120V, 277V, and 347V.

- **Power factor:** ≥ 0.90
- **Total Harmonic Distortion (THD):** $< 20\%$
- **Dimming Range:** 100%-10%
- **Expected driver lifetime:** 100,000 hours

LUTRON TUNABLE WHITE DRIVER OPTION:

LUT-TW (0.1% T-Series 2-Channel Digital Tunable White (PSQ Series)).

MOUNTING OPTIONS

HANGING HARDWARE:

- **Recessed T-Bar:** Standard bracket design works with most lay-in ceiling types. Brackets secure luminaire to the ceiling grid from above. Tie-in T-Bar brackets connect the luminaire to the T-Bar for securing to structure. Consult local codes for tie-wire recommendations.
- **Recessed Spackle Flange:** Drywall surfaces (walls or ceilings): 1/4" - 20 stud and nut (provided by others). Mounted with three equidistant suspension points.

TUNABLE WHITE HANGING HARDWARE: For grid ceiling applications the dual GridBox™ mounting is supplied (standard). For hard ceiling applications the ceiling mounting box is supplied (standard).

TUNABLE WHITE INTERCONNECTION CABLES: Luminaires are pre-wired with plug-and-play interconnection cables to support easy plug-together joining of fixture runs.

Continued

Submitted by:		Date:
Type:	Project:	
Ordering Info:		

High Performance 6" Aperture (HP-6) Recessed

SPECIFICATIONS

OTHER OPTIONS

ENDCAPS: Flat endcaps (**FE**) at each end of run add 1/16" to each end of luminaire.

EMERGENCY STYLE: Optional emergency to generator/inverter wiring, internal generator transfer switch, nightlight wiring, step-dimming driver, backup battery.

Backup Battery		
	Legrand 18W	Legrand 10W/ Bodine BSL310LP
HP6-R-D		
Min. Housing Length	6'	4'
EM Lumen Output	1885	1220
EM Section Illum.	2'	2' or 4'
HP6-EO-R-D		
Min. Housing Length	6*	4'
EM Lumen Output	2007	1193
EM Section Illum.	2'	4'

* Minimum fixture housing length for battery pack approved without sensor
The lumens are based on 835. For other CCT/CRI, refer to the Lumen Adjustment Factor table on page 9.

Bodine GTD and Legrand ALCR Min. Length	
Configuration	Min Length
Generator	D-2'
Generator + OCC	D-2'
Daylight	D-2'
Generator + Daylight	D-2'

TUNABLE WHITE ELECTRICAL OPTIONS¹:

- **TW Driver Options 0-10V:** EM/GEN, GTD or Battery Back up
- **DALI:** EM/GEN, GTD or Battery Back up
- **LUTRON:** EM/GEN, GTD or Battery Back up

INTEGRATED SENSORS: Integrated PIR (Passive Infrared) Occupancy (**OBO**) or Daylight Sensors (**OBD**) available with Flush and Bottom Glow downlight diffusers. PIR sensors not recommended for stairwell applications. Refer to Occupancy Sensor & Daylight Sensor tech sheet and the Embedded Intelligence landing page for more information and additional sensor options.

AIR HANDLING INFORMATION

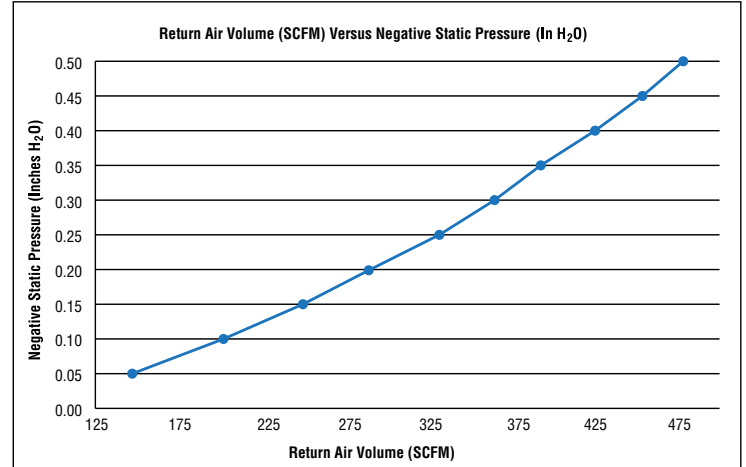

AIR RETURN: Luminaire tested in accordance with ADC1062 and ASHRAE 70. Air Return slots positioned along outside edge of luminaire. Consult factory for tailored lighting options.

FINISHES: Finelite Signal White (**SW**) powder coat, Finelite Black (RAL 9005) with semi gloss fine texture (**FB**) and Satin Aluminum (**SA**) are standard. Optional Adders: 179 RAL colors².

LABELS: Luminaire and electrical components are ETL-listed conforming to UL 1598 in the U.S.A. and CAN/CSA C22.2 No. 250.0 in Canada. In accordance with NEC Code 410.130 (G), this luminaire contains an internal driver disconnect. UL 924 and UL 2108 - PoE options available on request. These fixtures are rated for Damp Location. IC Rated. Finelite products use electronic components that are RoHS compliant, and the mechanical components of the luminaire have been verified to not knowingly contain any restricted substances listed per RoHS Directive 2015/863. Consult factory for tailored lighting options. Finelite makes the specification process easy when putting healthier products on your projects. Simply add - **RLA** (Red List Approved) or - **RLD** (Red List Declared Label) to your part number.

WEIGHT³: R - 3.7 lb/ft; EO R - 3.8 lb/ft

WARRANTY: 10-year performance-based warranty on all standard components. Optional accessories such as emergency battery packs are covered by their individual manufacturer warranties.

¹ Consult Finelite for Generator Transfer Device and Battery Backup fit

² 20 business days lead time for color

³ Excludes Battery Backup and Generator Transfer Device weight

Submitted by:		Date:
Type:	Project:	
Ordering Info:		

High Performance 6" Aperture (HP-6) Recessed

HARD CEILING MOUNTING OPTIONS

Threaded Rod Option

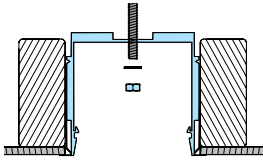

Screw Mount Option

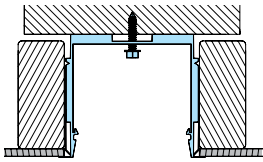

Mounting Location for Securing to Structure

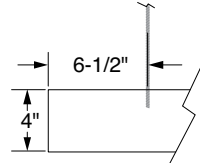

Two mounting options: threaded rod and screw mounting options. Mounting locations are located on each end of the luminaire. Mounting location is 6" away from each end of luminaire.

T-BAR INSTALLATION

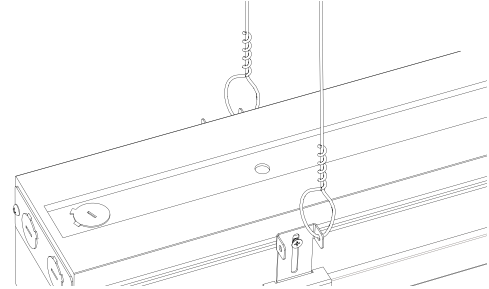

HP-6 R and HP-6 EO R for T-Bar installations comes standard with a splice plate at the end of the luminaire. Mounting brackets (supplied) secure the luminaire to T-Bar and provide support to structure location. All even foot length (2, 4, 6, ...) luminaire runs are reduced in length by an appropriate amount to fit within typical 2x2 and 2x4 T-Bar grid systems. For uncommon T-Bar systems please consult factory.

GRID LENGTH DETAIL - 4' EXAMPLE

1" T-Bar

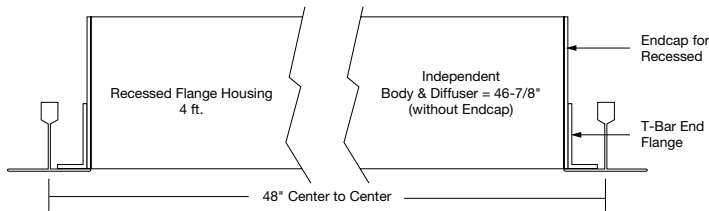

9/16" T-Bar

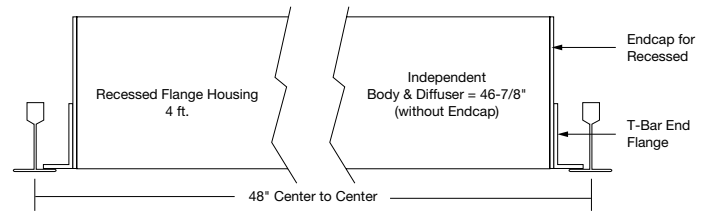

9/16" Screw Slot

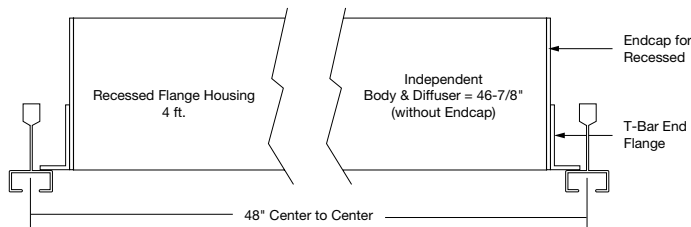

HARD CEILING LENGTH DETAIL - 4' EXAMPLE

Spackle Flange

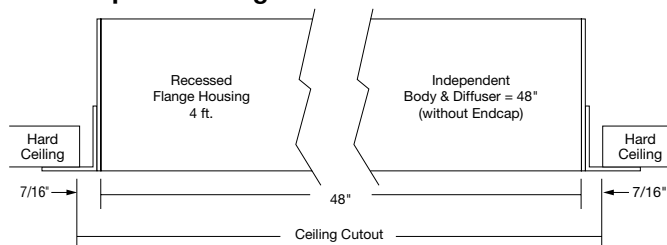

Visible Flange

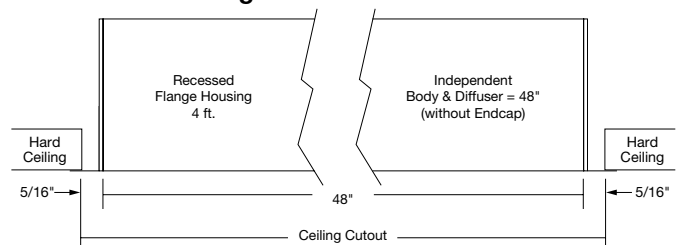

Submitted by:		Date:
Type:	Project:	
Ordering Info:		

High Performance 6" Aperture (HP-6) Recessed

RECESSED MOUNTING TYPES - T-BAR

Rough-In Dimensions

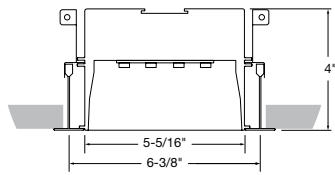

15/16" T-Bar (C1)

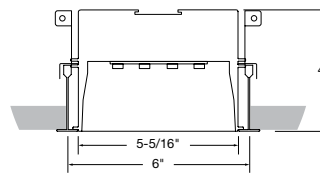

9/16" T-Bar (C2)

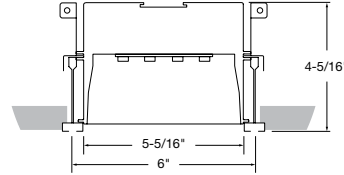

Standard Screw Slot (C3)

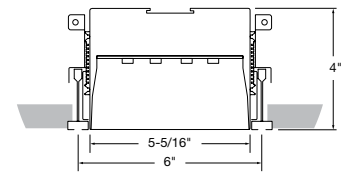

Flush Screw Slot (C3F)

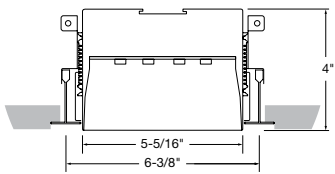

15/16" Tegular (C1T)

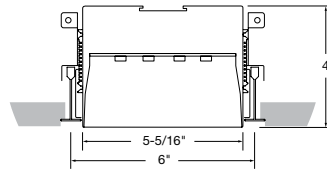

9/16" Tegular (C2T)

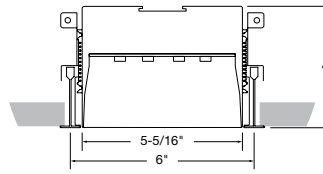

Tech Zone 6" (TZ6)
9/16" T-Bar (C2)

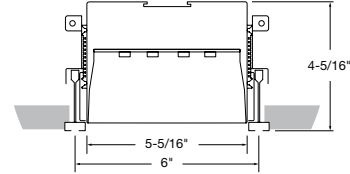

Tech Zone 6" (TZ6)
Standard Screw Slot (C3)

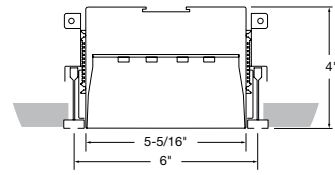

Tech Zone 6" (TZ6)
Flush Screw Slot (C3F)

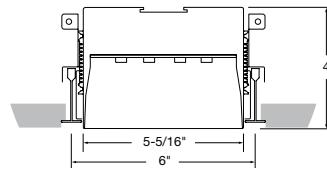

Tech Zone 6" (TZ6)
9/16" Tegular (C2T)

RECESSED MOUNTING TYPES - CUTOUT DIMENSIONS

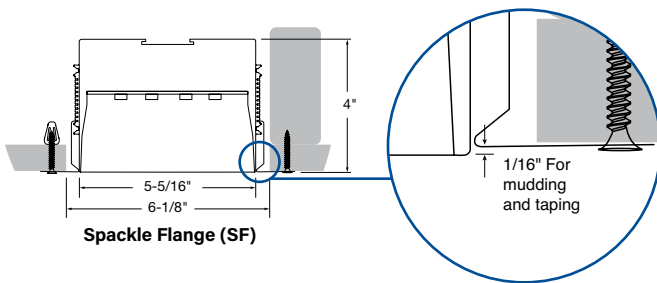

Spackle Flange (SF)

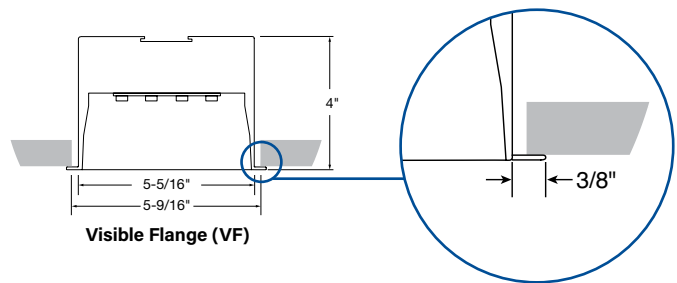

Visible Flange (VF)

HOUSING

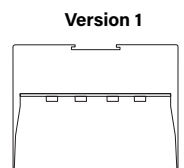

Ceiling Option VF

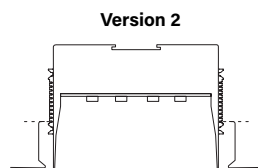

Ceiling Options
C1T, C2T, C3F, SF, TZ6

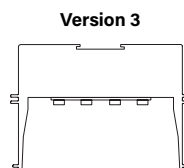

Ceiling Options
C1, C2, C3

Note: +/- 1/16"

Submitted by:		Date:
Type:	Project:	
Ordering Info:		

High Performance 6" Aperture (HP-6) Recessed

AIR RETURN MOUNTING TYPES - T-BAR

Rough-In Dimensions

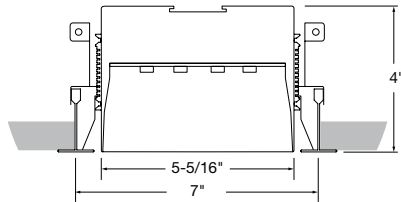

15/16" T-Bar (C1)

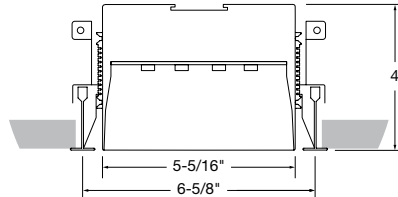

9/16" T-Bar (C2)

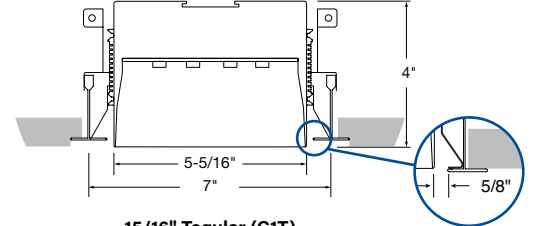

15/16" Tegular (C1T)

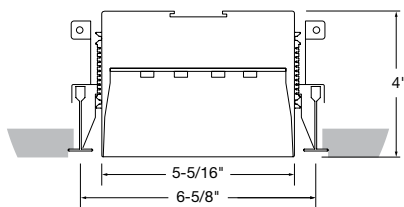

9/16" Tegular (C2T)

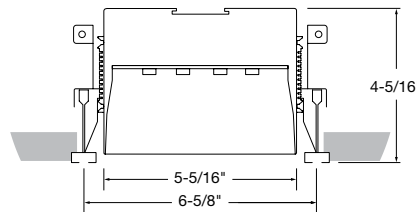

Standard Screw Slot (C3)

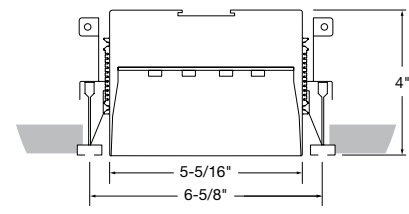

Flush Screw Slot (C3F)

AIR RETURN



Note: +/- 1/16"

Submitted by:		Date:
Type:	Project:	
Ordering Info:		

High Performance 6" Aperture (HP-6) Recessed

Direct Photometry - 4' Luminaire 3500K

HP6-R-D-4'-V-835

Downlight: Flush Diffuser

Efficacy: 100 lm/W

Total luminaire output: 3769 lumens (942 lm/ft)
37.6 watts (9.4 W/ft)

Peak Candela Value: 1360 @ 0°

CRI: 80 / CCT: 3500K

ITL LM79 Report 86098

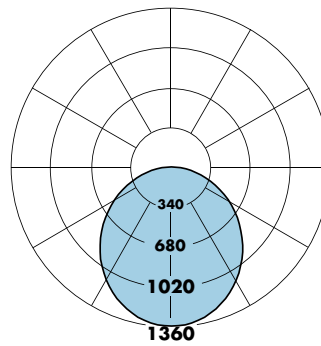

CANDELA DISTRIBUTION						
	0.0	22.5	45.0	67.5	90.0	FLUX
0	1360	1360	1360	1360	1360	
5	1353	1353	1353	1354	1354	129
15	1301	1293	1299	1300	1294	366
25	1193	1183	1192	1189	1185	547
35	1043	1034	1039	1036	1034	649
45	865	858	862	859	856	663
55	668	662	665	661	662	593
65	465	460	461	460	459	456
75	263	261	261	260	261	277
85	81	80	80	79	81	89
90	0	0	0	0	0	

Enhanced Output Direct Photometry - 4' Luminaire 3500K

HP6 EO-R-D-4'-V-835

Downlight: Flush Diffuser

Efficacy: 110 lm/W

Total luminaire output: 8026 lumens (2007 lm/ft)
73.2 watts (18.3 W/ft)

Peak Candela Value: 1436 @ 0°

CRI: 80 / CCT: 3500K

ITL LM79 Report 89078

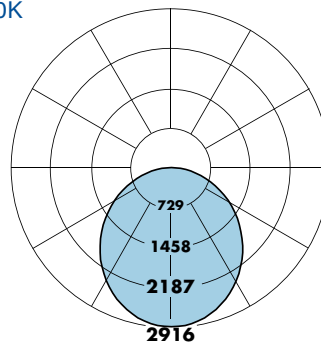

CANDELA DISTRIBUTION						
	0.0	22.5	45.0	67.5	90.0	FLUX
0	2915	2915	2915	2915	2915	
5	2092	2900	2900	2901	2900	276
15	2781	2765	2783	2784	2774	783
25	2542	2527	2544	2544	2535	1169
35	2218	2197	2217	2213	2208	1383
45	1833	1819	1832	1829	1828	1410
55	1414	1404	1413	1409	1408	1261
65	981	974	979	978	979	968
75	559	555	554	553	556	589
85	174	167	167	170	167	187
90	0	0	0	0	0	

Sample Lumen Adjustment Calculation

Lumen Adjustment Factors 80 CRI

3000K 0.985

3500K 1.000

4000K 1.032

Lumen Adjustment Factors 90 CRI

3000K 0.746

3500K 0.760

4000K 0.789

High Output (H), 4000K, 90 CRI

Lumen Adjustment Factor: 0.789

Total Light Output: 2931 lm x 0.789 = 2313 lm

Total Light Output per Foot: 733 lm/ft x 0.789 = 578 lm/ft.

watts/foot: 7.2 W/ft.

$$\text{Efficacy} = \frac{578 \frac{\text{lm}}{\text{ft.}}}{7.2 \frac{\text{W}}{\text{ft.}}} = 80 \text{ lm/W}$$

Total Light Output, 3500K, 80 CRI (Lumens) - 4' Luminaire

HP-6 R				HP-6 EO R		
S ¹	B ¹	H ¹	V ²	H	V	X
1543	1940	2931	3769	6242	8026	9082

Light Output, 3500K, 80 CRI (Lumens Per Foot)

HP-6 R				HP-6 EO R		
S ¹	B ¹	H ¹	V ²	H	V	X
386	485	733	942	1561	2007	2271

Power, 3500K (Watts Per Foot)

HP-6 R				HP-6 EO R		
S ¹	B ¹	H ¹	V ²	H	V	X
3.7	4.7	7.2	9.4	14.0	18.3	21.1

Efficacy, 3500K, 80 CRI (Lumens Per Watt)

HP-6 R				HP-6 EO R		
S ¹	B ¹	H ¹	V ²	H	V	X
105	104	102	100	111	110	108

S - Standard Output, B - Boosted Standard Output, H - High Output, V - Very High Output

¹ Family Correlation based on 4' luminaire 3500K Very High Output (V) test - 120V.

² Based on ITL report: 86098

³ Based on ITL report: 89078

Wattage is Real Power. If you would like additional details to calculate Apparent Power, please contact your local Finelite representative.

Submitted by:		Date:
Type:	Project:	
Ordering Info:		

0-10V Tunable White

Finelite's award-winning, contractor friendly Tunable White luminaires are available at low cost, with powerful and simple 0-10V tuning and intensity controls.

TUNABLE WHITE FEATURES

- CCT range: 2700K - 6500K
- Dimming Range: 100% to 10%
- CRI Options: 80 CRI or 90 CRI

PHOTOMETRY

Apply a power adjustment factor to calculate wattage usage

POWER	CONVERSION FACTOR
	1.1X

(Example: a 50 watt luminaire in static white would draw 55 watts using 0-10V Tunable White)

LUMINAIRE FAMILY MODIFICATIONS/RESTRICTIONS

Recessed Direct	Section Lengths											
	2'	3'	4'	5'	6'	7'	8'	9'	10'	11'	12'	
Output S,B,H,V Single Circuit	Rows can be comprised of 2'-12' sections. Tailored lengths available.											
Integral Battery Backup (BSL310LP)								✓	✓	✓		

WIRING DIAGRAM - DIMMABLE TO 10%

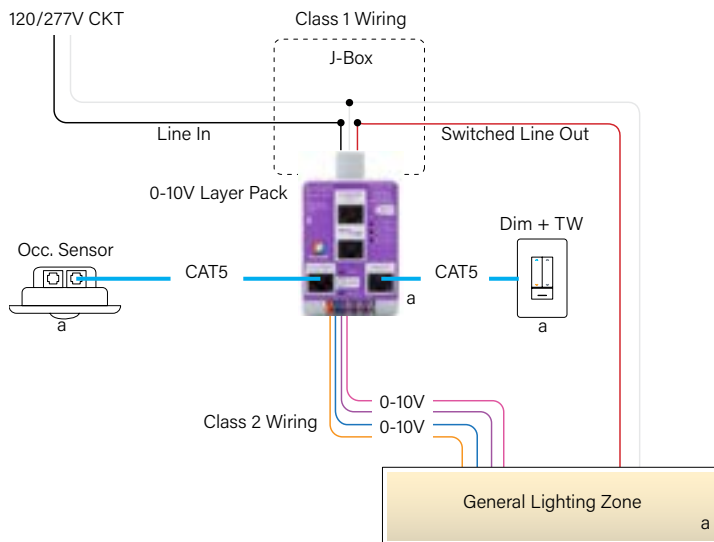

Luminaire Wiring

- **Purple (+) / Pink (-)** control wires are for intensity control
- **Orange (+) / Blue (-)** control wires are for Tunable White control

Note:

Load or Dim to Off options available.

DUAL FEED DETAIL

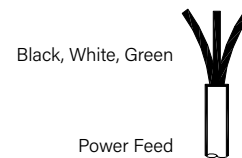

WIRING LEGEND		
Black	Hot	Line Voltage
White	Neutral	Line Voltage
Green	Ground	

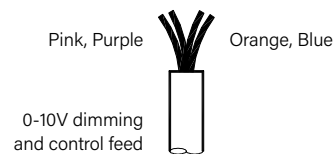

WIRING LEGEND		
Pink	Dimming	0-10V DC
Purple	Dimming	0-10V DC
Orange	TW	0-10V DC
Blue	TW	0-10V DC

