

|                |          |       |
|----------------|----------|-------|
| Submitted by:  |          | Date: |
| Type:          | Project: |       |
| Ordering Info: |          |       |

# High Performance 2" Aperture (HP-2) Recessed

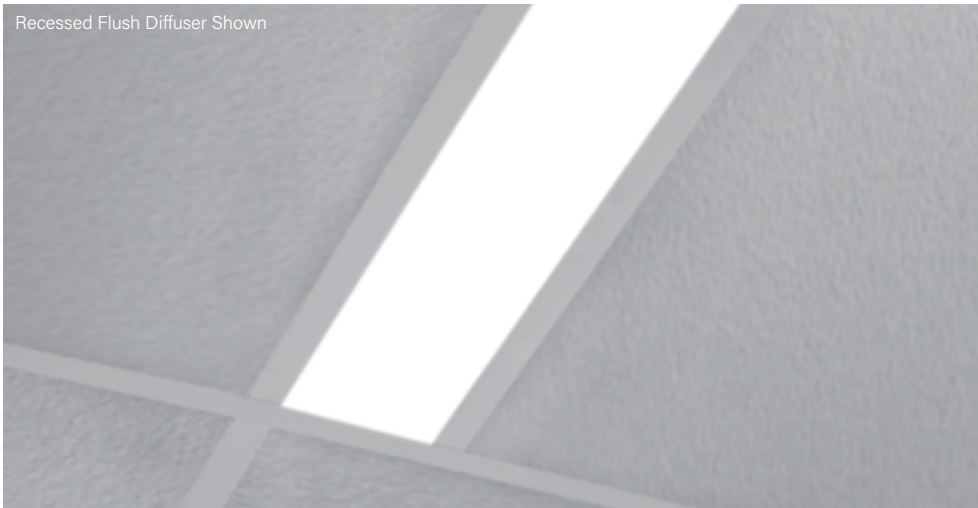

High Performance 2" Aperture is a patented, linear LED luminaire family. HP-2 delivers excellent performance using an advanced optical design and mid-power LEDs. Achieving 90% of initial light output at 100,000+ hours and backed by a 10-year performance-based warranty on all standard components.

This product is enrolled in the International Living Future Institute (ILFI) Declare 2.0 Program and is third-party verified with options achieving **Red List Approved** and **Red List Declared** status.

**Note:** see page 6 for all aesthetic options

## CROSS SECTIONS

### Recessed

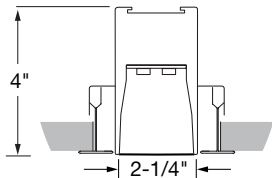

Flush Downlight Diffuser (standard)

### Regressed

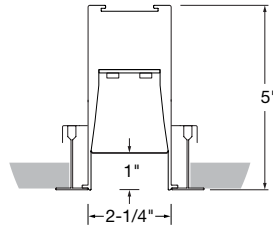

Flat Diffuser with 1" Regressed

### Wall Wash Recessed

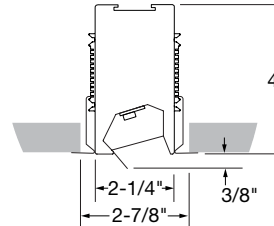

Kicker (standard)

## OPTIC OPTIONS

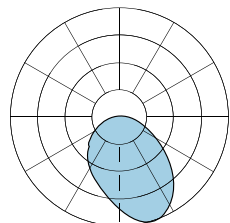

Downlight Asymmetric Optic (DAO)

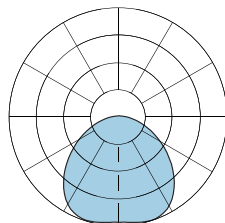

Downlight Spread Optic (DSO)

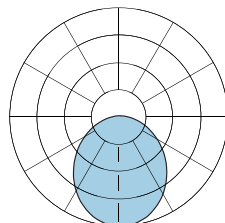

Standard Downlight Flush Optic (F)

## ALSO AVAILABLE IN



Pendant (D, ID, I)



Wall Mount (WM)



Surface Mount (SM)



|                |          |       |
|----------------|----------|-------|
| Submitted by:  |          | Date: |
| Type:          | Project: |       |
| Ordering Info: |          |       |

# High Performance 2" Aperture (HP-2) Recessed

Ordering Guide Example: HP - 2 - R - D - 36' - S - 835 - F - 96LG - 120 - SC - FC-10% - FA50 - C1 - FE - SW - LGD18W - OBO - CP

| BODY TYPE             |             |   |                         | OUTPUT AND LED TYPE   |  |                             |
|-----------------------|-------------|---|-------------------------|---|--|-----------------------------|
| Platform              | Series Name | Luminaire Type                                      | Luminaire Distribution  | Total Length of Run   | Downlight Output (Flush)   | LED CRI/CCT                 |
| HP - High Performance | 2           | R - Recessed  | D - Direct              | Minimum 2' section length. Increments accurate to 1/16" (±1/32"), standard. 12' maximum section length. | S - Standard (336 lm/ft)   | 830 - 80 CRI, 3000K         |
|                       |             | R RG - Recessed Regressed (Wall Wash not available) | WW-D - Wall Wash Direct |   | B - Boosted (423 lm/ft)  | 835 - 80 CRI, 3500K         |
|                       |             |   |                         |   | H - High (639 lm/ft)   | 840 - 80 CRI, 4000K         |
|                       |             |   |                         |   | V - Very High (822 lm/ft)  | 930 - 90 CRI, 3000K         |
|                       |             |   |                         |   | TL - Tailored: _____ lm/ft*  | 935 - 90 CRI, 3500K         |
|                       |             |   |                         |   | Lumen provided above are for Flush lens only, see pg. 12 for WW lumens   | 940 - 90 CRI, 4000K         |
|                       |             |   |                         |   | * Specify Tailored lm/ft of outputs between Standard (S) and Very High (V). Consult factory for tailored lumen output outside of this range. | 8TW - 80 CRI, Tunable White |
|                       |             |   |                         |   |  | 9TW - 90 CRI, Tunable White |

| MECHANICAL/OPTICAL OPTIONS                            |                                      |                   | ELECTRICAL OPTIONS  |  |
|---|--------------------------------------|-------------------|---|--|
| Downlight   | Reflector System                     | Voltage           | Circuiting <sup>2</sup>   |  |
| F - Flush (standard) <sup>8,9</sup>                   | 96LG - 96 Low Gloss White            | 120 - 120 Voltage | SC - Single Circuit*<br>One single circuit in a run                                     |  |
| DL - 1" Drop Down Lens <sup>8</sup>                   | SW - Signal White for Wall Wash only | 277 - 277 Voltage | MC - Multi-Circuit*<br>More than one switch leg or zone. Factory shop drawings required |  |
| RG-D - Flat Diffuser with 1" Regress <sup>1,8</sup>   |                                      | 347 - 347 Voltage |   |  |
| RG-WCB - White Cross Blade Baffle <sup>1,8</sup>      |                                      |                   |   |  |
| RG-LHE - Hollowed Ellipse Louver <sup>1,8</sup>       |                                      |                   |   |  |
| RG-LHC - Hex Louver <sup>1,8</sup>                    |                                      |                   |   |  |
| DAO-L - Downlight Asymmetric Left <sup>4,8</sup>      |                                      |                   |   |  |
| DAO-R - Downlight Asymmetric Right <sup>4,8</sup>     |                                      |                   |   |  |
| DSO - Downlight Spread Optic <sup>4,8</sup>           |                                      |                   |   |  |
| K - Kicker for Wall Wash only (standard) <sup>5</sup> |                                      |                   |   |  |
| FO - Fully Open for Wall Wash only                    |                                      |                   |   |  |

\* Battery, Night Light, and Emergency to Generator circuits are in addition to the normal luminaire circuit(s)

## ELECTRICAL OPTIONS

### Driver Selection

#### 0-10V Driver Options

- FC-10% - 0-10V 10% (standard)
- FC-1% - 0-10V 1%
- OTI-10% - EldoLED OTI, 0-10V 10%<sup>3</sup>
- OTI-1% - EldoLED OTI, 0-10V 1%<sup>3</sup>
- ELD-10V-0% - EldoLED SOLOdrive, 0-10V 0.1%
- 10V-TW-10% - EldoLED OTI, 0-10V 10% (Tunable White)<sup>3</sup>

#### DALI Driver Options

- FC-DALI-1% - DALI 1%
- DXL-DALI-1% - EldoLED Dexas, 1%
- ELD-DALI-0% - EldoLED SOLOdrive, 0.1%
- ELD-DALI-TW - EldoLED DUALdrive LightShape, 0.1% (Tunable White)

#### Lutron Driver Options

- LUT-ES1 - Lutron, Ecosystem 1%
- LUT-TW - Lutron T-Series, EcoSystem 0.1% (Tunable White)

See Page 3 for additional driver options and details

## MOUNTING OPTIONS

### Ceiling Hardware Type

- C1 - 15/16" T-Bar
- C1T - 15/16" Tegular
- C2 - 9/16" T-Bar
- C2T - 9/16" Tegular
- C3 - Screw Slot
- C3F - Flush Screw Slot
- SF - Spackle Flange
- VF - Visible Flange
- TZ4 - Tech Zone 4" \_\_\_\_\_ (C1, C2, C2T, C3, C3F)

## OTHER OPTIONS

### Endcap Style

- FE - Flat Endcap (standard)

### Finish

- SW - Signal White (standard)
- FB - Finelite Black
- SA - Satin Aluminum
- #### - RAL Color Code<sup>7</sup> \_\_\_\_\_

## OTHER OPTIONS

### Emergency Style (Optional)

See page 5 Backup Battery table

- LGD18W - Legrand 18W Brand Battery Back-up
- LGD10W - Legrand 10W Brand Battery Back-up
- EM/GEN - Emergency to Generator
- NL - Night Light
- BSL310LP - Bodine Battery Back up Low Profile
- GTD - Generator Transfer Device
- ALCR - Automatic Load Control Relay

### Integrated Sensor (Optional)<sup>8</sup>

- OBO - Occupancy<sup>9</sup>
- OBD - Daylight<sup>9</sup>
- W601 - Wattstopper Wireless Sensor<sup>10</sup>
- OBE - Enlighted<sup>11</sup>
- REE - Remote Enlighted<sup>12</sup>
- RLM-99 - Encelium RF
- SLM-99 - Encelium Sensor
- AOCC-W - Lutron Athena Sensor (Device Color White)<sup>13</sup>
- AOCC-B - Lutron Athena Sensor (Device Color Black)<sup>13</sup>
- ARF-W - Lutron Athena RF (Device Color White)<sup>13</sup>
- ARF-B - Lutron Athena RF (Device Color Black)<sup>13</sup>
- VOCC - Lutron Vive Wireless Sensor (VDO)<sup>14</sup>
- VRF - Lutron Vive Radio Only<sup>14</sup>

### Special Options (Optional)

- CP - Chicago Plenum<sup>15</sup>
- FLX - Flex Whip
- RLA - Red List Approved
- RLD - Red List Declared

<sup>1</sup> Recessed Regressed straight run only

<sup>2</sup> Contact factory for switching options

<sup>3</sup> Add DTG to gain "Dim to Off" functionality (FC-10% - DTO, FC-1% - DTO)

<sup>4</sup> Not available with Regressed or Curves

<sup>5</sup> Kicker standard in Signal White. Customer Custom color kickers have a surcharge

<sup>6</sup> B & V outputs only

<sup>7</sup> 20 business days lead time for color

<sup>8</sup> Minimum fixture length with a sensor is 3ft.

<sup>9</sup> Not available with Wall Wash

<sup>10</sup> LMFS-601 w/ 0-10V driver(s) and LMFI-111, up to 6 drivers may be connected.

<sup>11</sup> LMFS-601 w/ Dali driver, only 1 driver can be connected.

<sup>12</sup> Enlighted components installed by Finelite, provided by others

<sup>13</sup> Enlighted for Wall Wash fixtures. Enlighted Control Unit & Sensor Cable installed for Remote mounting sensor.

<sup>14</sup> 0-10V Drivers - AOCC up to 10 drivers may be connected; ARF up to 40 drivers may be connected DALI Drivers - AOCC & ARF up to 4 drivers can be connected.

<sup>15</sup> Lutron Vive Integrated Sensors require a DALI driver

<sup>16</sup> Only available with C1, C2, and C3 mounting hardware with Finelite Gridbox

|                |          |       |
|----------------|----------|-------|
| Submitted by:  |          | Date: |
| Type:          | Project: |       |
| Ordering Info: |          |       |

# High Performance 2" Aperture (HP-2) Recessed

## SUPPLEMENTARY DRIVER PAGE

### 0-10V Driver Options

|                       |   |
|-----------------------|---|
| <b>FC-10%</b>         | Factory Choice, 0-10V 10% Dimming (Linear)                                |
| <b>FC-10%-DTO</b>     | Factory Choice, 0-10V 10% Dimming, Dim-to-Off (Linear)                    |
| <b>FC-1%</b>          | Factory Choice, 0-10V 1% Dimming (Linear)                                 |
| <b>FC-1%-DTO</b>      | Factory Choice, 0-10V 1% Dimming, Dim-to-Off (Linear)                     |
| <b>ELD-10V-0%</b>     | EldoLED SOLOdrive, 0-10V 0.1% Dimming (Linear)                            |
| <b>ELD-10V-1%</b>     | EldoLED ECOdrive, 0-10V 1% Dimming (Linear)                               |
| <b>10V-TW-10%</b>     | EldoLED OTi, 0-10V 10% Dimming, <i>Tunable White</i> (Linear)             |
| <b>10V-TW-10%-DTO</b> | EldoLED OTi, 0-10V 10% Dimming, Dim-to-Off, <i>Tunable White</i> (Linear) |
| <b>OTi-10%</b>        | EldoLED OTi, 0-10V 10% Dimming (Linear)                                   |
| <b>OTi-10%-DTO</b>    | EldoLED OTi, 0-10V 10% Dimming, Dim-to-Off (Linear)                       |
| <b>OTi-1%</b>         | EldoLED OTi, 0-10V 1% Dimming (Linear)                                    |
| <b>OTi-1%-DTO</b>     | EldoLED OTi, 0-10V 1% Dimming, Dim-to-Off (Linear)                        |

### DALI Driver Options

|                    |  |
|--------------------|--|
| <b>FC-DALI-1%</b>  | Factory Choice, DALI 1% Dimming (Logarithmic)  |
| <b>DXL-DALI-1%</b> | EldoLED Dexal, DALI 1% Dimming (Logarithmic)   |
| <b>ELD-DALI-0%</b> | EldoLED SOLOdrive, DALI 0.1% Dimming (Logarithmic)   |
| <b>ELD-DALI-1%</b> | EldoLED ECOdrive, DALI 1% Dimming (Logarithmic)  |
| <b>ELD-DALI-TW</b> | EldoLED DUALdrive Light Shape, DALI 0.1% Dimming, <i>Tunable White</i> (Logarithmic Dimming, Linear CCT Control) |

### Lutron Driver Options

|                |   |
|----------------|---|
| <b>LUT-ES1</b> | Lutron, Ecosystem 1% Dimming                                  |
| <b>LUT-TW</b>  | Lutron T-Series, EcoSystem 0.1% Dimming, <i>Tunable White</i> |

|                |          |       |
|----------------|----------|-------|
| Submitted by:  |          | Date: |
| Type:          | Project: |       |
| Ordering Info: |          |       |

# High Performance 2" Aperture (HP-2) Recessed

## SPECIFICATIONS

### BODY TYPE

**CONSTRUCTION:** Precision-cut 6063-T6 extruded aluminum body. Internal joiner system and plug-together wiring are standard.

**LENGTHS:** Any length, 2' minimum, in increments down to 1/16th" (±1/32"). 12' maximum section length. Hollowed Ellipse Louver (**LHE**), Hex Louver (**LHC**), and White Cross Blade Baffle (**WCB**) are available in 1' increments.

**MITERED CORNERS**<sup>1</sup> : Illuminated corners of greater than 60° and less than 180° in a single plane, available with Flush Diffuser, Bottom Glow Diffuser, Regressed Diffuser, or White Cross Blade Baffle<sup>2</sup>. Corners not available with Wall Wash (**WW-D**), Hollowed Ellipse Louver (**LHE**), Hex Louver (**LHC**) or 1" Drop Down Lens. Contact factory for Double miters using the White Cross Blade Baffle. Consult factory for tailored lighting options.

### OUTPUT AND LED TYPE

**LIGHT OUTPUT:** Four lumen packages available, Standard (**S**), Boosted Standard (**B**), High (**H**), and Very High (**V**). For lengths 3' and greater, the uplight and downlight can be specified with different lumen packages and dual controls. For Tailored Outputs outside of range from Standard (**S**) to Very High (**V**), consult factory. Light engines are replaceable.

### MECHANICAL/OPTICAL OPTIONS

**DOWNLIGHT OPTION:** 12' maximum diffuser length. Flush frost white snap-in diffuser standard, 73% transmissive, 99% diffusion. Internal secondary diffusers at corners ensure visually seamless, uniform, continuous illumination. Available with Flush (**F**), Bottom Glow (**BG**), 1" Drop Down Lens (**DL**), White Cross Blade Baffle (**WCB**)<sup>3,4</sup>, Ellipse Louver (**LHE**)<sup>3</sup>, Hex Louver (**LHC**)<sup>3</sup>, Downlight Asymmetric Optic (**DAO**)<sup>5</sup>, Downlight Spread Optic (**DSO**)<sup>5</sup>, and Regressed downlight diffusers (**RG**)<sup>3</sup>. 1" Drop Down Lens made of highly efficient acrylic. Available with a solid endcap or an endcap with a diffuse filler to continue the luminous aesthetic. Downlight Spread & Downlight Asymmetric Optics are extruded lenses with a subtle ribbed appearance providing a batwing or asymmetric distribution for improved optical performance. Consult factory for more tailored lumen outputs.

**LUMEN MAINTENANCE:** 90% of initial light output (L90) at 100,000+ hours; 70% of initial light output (L70) at 200,000+ hours.

**REFLECTORS:** Die-formed 20-gauge cold-rolled steel reflectors finished in 96LG High Reflectance white powder coat paint. The standard Semi-Specular Aluminum (**SSA**) Kicker (**K**) reflector delivers light high on the vertical surface. The Kicker reflector can be easily removed for open distribution (**FO**).

### ELECTRICAL OPTIONS

**STATIC WHITE FEED:** Standard with one 18-gauge/5-conductor single-circuit feed wire controlling uplight and downlight together (power and dimming). Specify dual feed wires for independent control of uplight and downlight. 14-gauge feed wire used when luminaire current exceeds 5 amps.

**TUNABLE WHITE FEED:** Standard with one 18-gauge/5-conductor single-circuit feed. 14-gauge feed used when luminaire current exceeds 5 amps.

**STATIC WHITE DRIVER:** Replaceable 120V, 277V, and 347V constant current reduction dimming driver standard. Can be wired dimming or non-dimming. 0-10V dimming controls with a range of 10%- 100% standard. Dimming to 1% available. Separate dimming for uplight and downlight available. Driver is fully accessible from below the ceiling.

- **Power Factor:** ≥ 0.9

- **Total Harmonic Distortion (THD):** <20%

- **Expected driver lifetime:** 100,000 hours

### LUTRON DRIVER OPTIONS:

- **LUT-ES1 (LDE1)** - (Hi-lume 1% EcoSystem with Soft-On, Fade-to-Black dimming (LDE1 series))

**TUNABLE WHITE DRIVER:** Replaceable LED driver. Driver is accessible from below the ceiling. 120V, 277V, and 347V.

- **Power factor:** ≥0.90

- **Total Harmonic Distortion (THD):** <20%

- **Dimming Range:** 100%-10%

- **Expected driver lifetime:** 100,000 hours

### LUTRON TUNABLE WHITE DRIVER OPTION:

**LUT-TW** (1% T-Series 2-Channel Digital Tunable White (PSQ Series)).

### MOUNTING OPTIONS

#### HANGING HARDWARE:

- **Recessed T-Bar:** Standard bracket design works with most lay-in ceiling types. Brackets secure luminaire to the ceiling grid from above. Tie-in T-Bar brackets connect the luminaire to the T-Bar for securing to structure. Consult local codes for tie-wire recommendations.

- **Recessed Spackle Flange:** Drywall surfaces (walls or ceilings): 1/4" - 20 stud and nut (provided by others). Mounted with three equidistant suspension points.

<sup>1</sup> Not available with Wall Wash

<sup>2</sup> White Cross Blade (WCB) baffles not available with custom angles. Available in 90 degrees only

<sup>3</sup> Recessed Regressed straight run only

<sup>4</sup> White Cross Blade Baffle (WCB) currently not advisable for drywall

<sup>5</sup> Not available with Regressed or Curves

|                |          |       |
|----------------|----------|-------|
| Submitted by:  |          | Date: |
| Type:          | Project: |       |
| Ordering Info: |          |       |

# High Performance 2" Aperture (HP-2) Recessed

## SPECIFICATIONS

**TUNABLE WHITE HANGING HARDWARE:** For grid ceiling applications the dual GridBox™ mounting is supplied (standard). For hard ceiling applications the ceiling mounting box is supplied (standard).

**TUNABLE WHITE INTERCONNECTION CABLES:** Luminaires are pre-wired with plug-and-play interconnection cables to support easy plug-together joining of fixture runs.

## OTHER OPTIONS

**ENDCAPS:** Flat endcaps (**FE**) at each end of run add 1/16" to each end of luminaire. Drop Down Lens Illuminated Endcap (**DE**) includes diffuse element to continue luminance of drop lens.

**EMERGENCY STYLE:** Optional emergency to generator/inverter wiring, internal generator transfer switch, nightlight wiring, step-dimming driver, backup battery.

| Backup Battery         |             |                               |
|------------------------|-------------|-------------------------------|
|                        | Legrand 18W | Legrand 10W / Bodine BSL310LP |
| <b>HP2-R-D</b>         |             |                               |
| Min. Housing Length    | 8'*         | 4!**                          |
| EM Lumen Output        | 1608        | 956                           |
| EM Section Illuminated | 2'          | 2' or 4'                      |
| <b>HP2-R-WW-D</b>      |             |                               |
| Min. Housing Length    | 8'*         | 4'*                           |
| EM Lumen Output        | 1500        | 891                           |
| EM Section Illuminated | 4'          | 4'                            |

\* Minimum fixture housing length for battery pack approved without sensor. \*\* Exception: 5' not available, 6'+ okay. The lumens are based on 835. For other CCT/CRI, refer to the Lumen Adjustment Factor table on page 11.

## TUNABLE WHITE ELECTRICAL OPTIONS 6:

- **TW Driver Options 0-10V:** EM/GEN, GTD or Battery Back up
- **DALI:** EM/GEN, GTD or Battery Back up
- **LUTRON:** EM/GEN, GTD or Battery Back up

**INTEGRATED SENSORS:** Integrated PIR (Passive Infrared) Occupancy (**OBO**) or Daylight Sensors (**OBD**) available with Flush and Bottom Glow downlight diffusers. PIR sensors not recommended for stairwell applications. Refer to Occupancy Sensor & Daylight Sensor tech sheet and the Embedded Intelligence landing page for more information and additional sensor options. Minimum fixture length with a sensor is 3ft.

**FINISHES:** Finelite Signal White (**SW**) powder coat, Finelite Black (RAL 9005) with semi gloss fine texture (**FB**), and Satin Aluminum (**SA**) are standard. Optional Adder: 179 RAL colors 7 are available.

**LABELS:** Luminaire and electrical components are ETL-listed conforming to UL 1598 in the U.S.A. and CAN/CSA C22.2 No. 250.0 in Canada. In accordance with NEC Code 410.130 (G), this luminaire contains an internal driver disconnect. UL 924 and UL 2108 - PoE options available on request. These fixtures are rated for Damp Location. IC Rated. HP-2 can be used to comply with 2016 Title 24, Part 6 (JA8); high efficacy LED light source requirements. Finelite products use electronic components that are RoHS compliant, and the mechanical components of the luminaire have been verified to not knowingly contain any restricted substances listed per RoHS Directive 2015/863. Consult factory for tailored lighting options. Finelite makes the specification process easy when putting healthier products on your projects. Simply add - **RLA** (Red List Approved) or - **RLD** (Red List Declared) to your part number.

**WEIGHT 8:** R - 2.3 lb/ft; WW-R - 2.9 lb/ft

**WARRANTY:** 10-year performance-based warranty on all standard components. Optional accessories such as emergency battery packs are covered by their individual manufacturer warranties.

| Bodine GTD and Legrand ALCR Min. Length |            |
|---|------------|
| Configuration                           | Min Length |
| Generator                               | 6'         |
| Generator + OCC                         | 8'         |
| Daylight                                | 6'         |
| Generator + Daylight                    | 8'         |

6 Consult Finelite for Generator Transfer Device and Battery Backup fit

7 20 business days lead time for color

8 Excludes Battery Backup and Generator Transfer Device weight

|                |          |       |
|----------------|----------|-------|
| Submitted by:  |          | Date: |
| Type:          | Project: |       |
| Ordering Info: |          |       |

# High Performance 2" Aperture (HP-2) Recessed

## AESTHETIC OPTIONS



Flush Diffuser (**F**)



1" Drop Down Lens (**DL**)

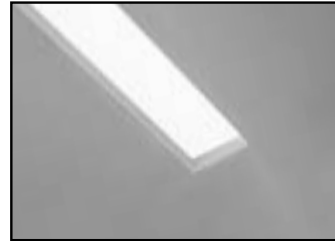

Flat Diffuser with 1" Regressed (**RG-D**)

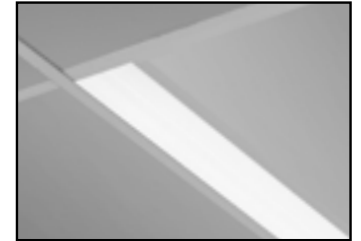

Downlight Asymmetric Optic (**DAO**)<sup>1</sup>  
Externally flush



Downlight Spread Optic (**DSO**)<sup>1</sup>  
Externally flush



White Cross Blade Baffle<sup>2</sup> (**RG-WCB**)

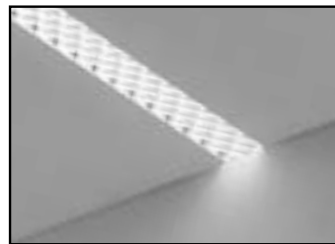

Hex Louver<sup>2</sup> (**RG-LHC**)

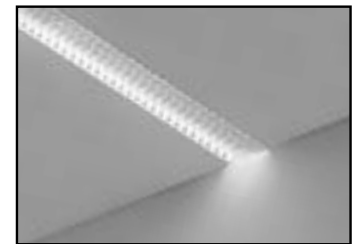

Hollowed Ellipse Louver<sup>2</sup> (**RG-LHE**)

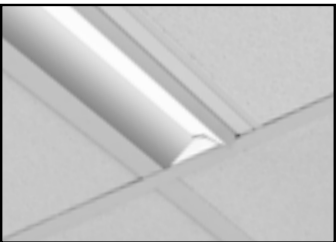

Kicker (**K**) - Wall Wash only

<sup>1</sup> With a subtle ribbed appearance providing specialized distribution

<sup>2</sup> Regressed only. Not available with Wall Wash

|                |          |       |
|----------------|----------|-------|
| Submitted by:  |          | Date: |
| Type:          | Project: |       |
| Ordering Info: |          |       |

# High Performance 2" Aperture (HP-2) Recessed

## DOWNLIGHT ASYMMETRIC OPTIONS

The diagrams below show a linear run from power feed to ender. Specifying DAO-L distributes light to the left or DAO-R distributes light to the right. For proper orientation: view luminaire from starter end when specifying the direction of the Downlight Asymmetric optic.

### Downlight Asymmetric Optic Left (DAO-L)

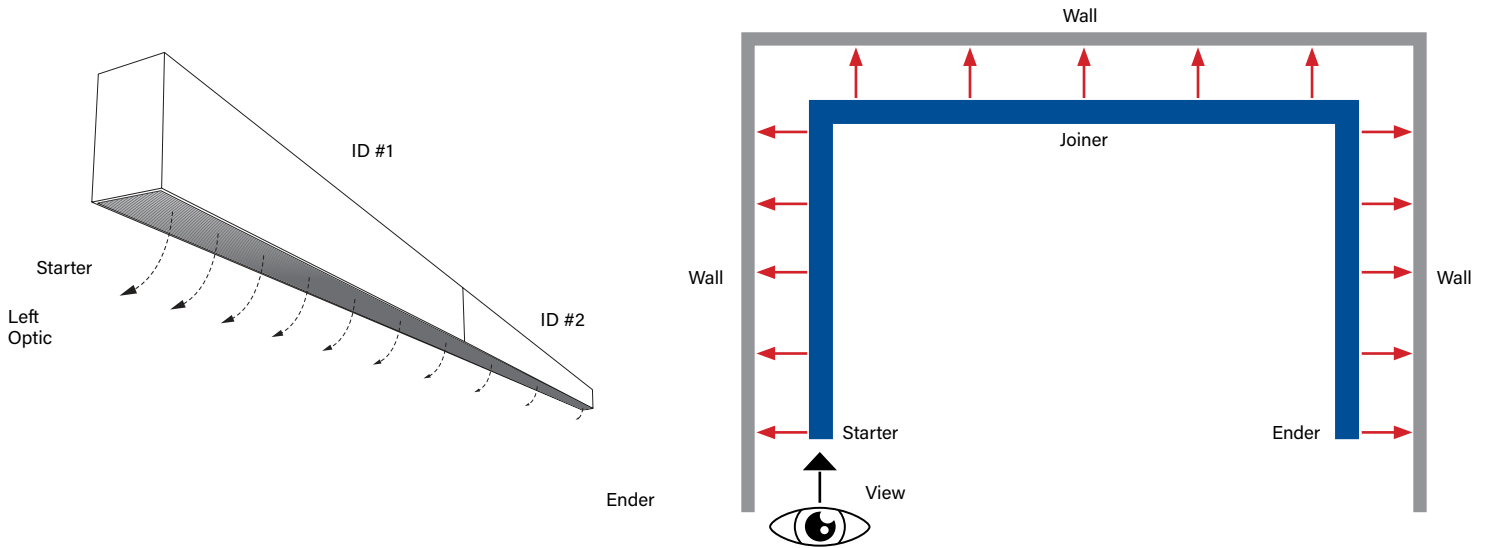

### Downlight Asymmetric Optic Right (DAO-R)

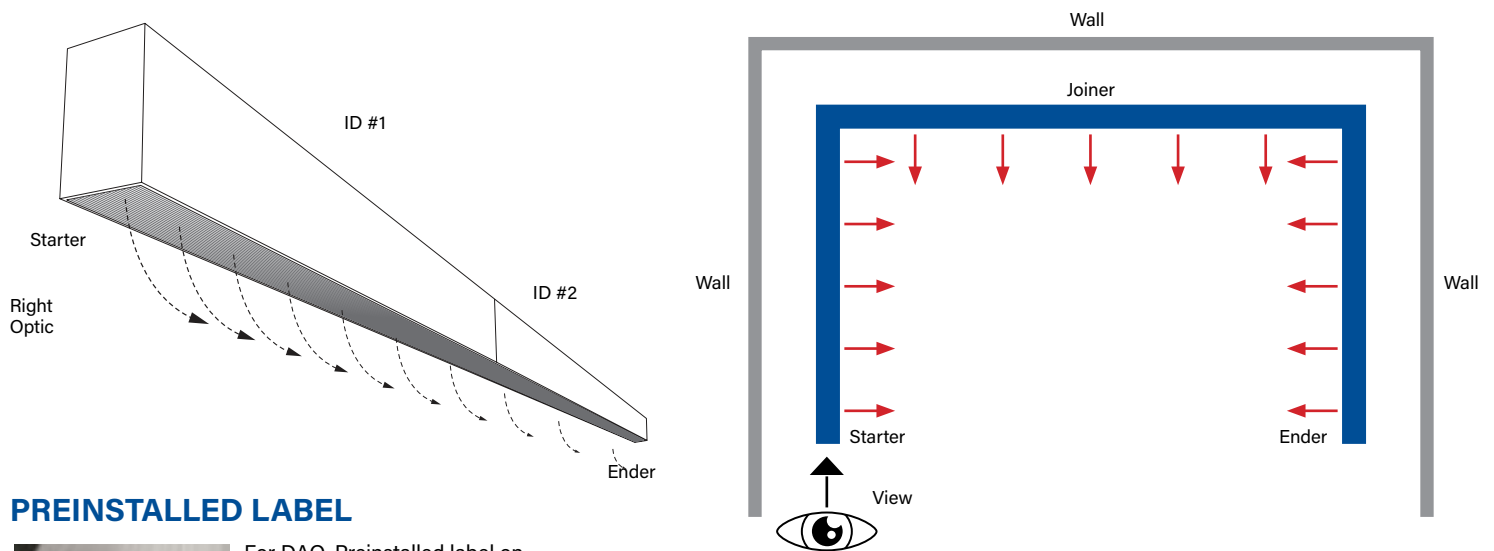

## PREINSTALLED LABEL



For DAO, Preinstalled label on diffuser shows direction of light. Remove after installation.



|                |          |       |
|----------------|----------|-------|
| Submitted by:  |          | Date: |
| Type:          | Project: |       |
| Ordering Info: |          |       |

# High Performance 2" Aperture (HP-2) Recessed

## HARD CEILING MOUNTING OPTIONS

**Threaded Rod Option**

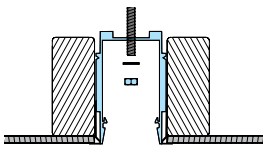

**Screw Mount Option**

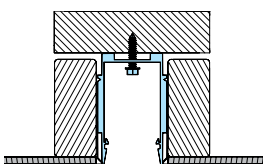

**Mounting Location for Securing to Structure**

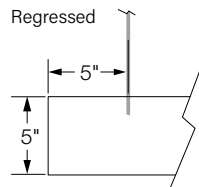
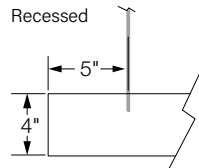

Two mounting options: threaded rod and screw mounting options. Mounting locations are located on each end of the luminaire. Mounting location is 5" away from each end of luminaire.

## T-BAR INSTALLATION

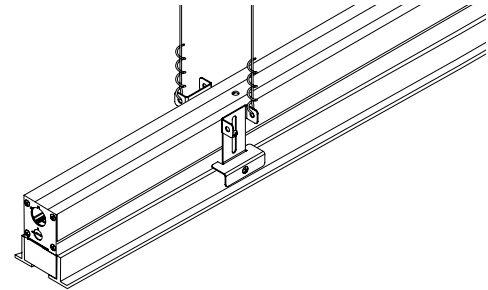

HP-2 R for T-Bar installations comes standard with a splice plate at the end of the luminaire. Mounting brackets (supplied) secure the luminaire to T-Bar and provide support to structure location. All even foot length (2, 4, 6, ...) luminaire runs are reduced in length by an appropriate amount to fit within typical 2x2 and 2x4 T-Bar grid systems. For uncommon T-Bar systems please consult factory.

## GRID LENGTH DETAIL - 4' EXAMPLE

**1" T-Bar**

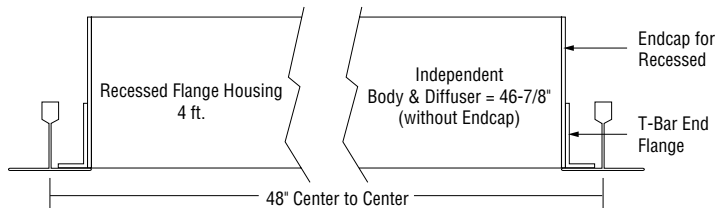

**9/16" T-Bar**

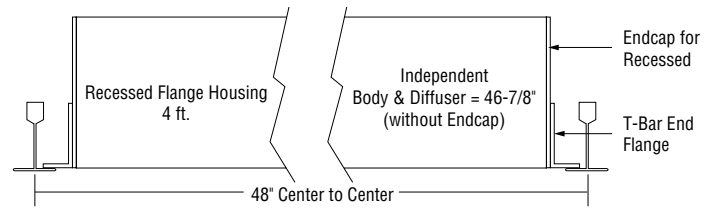

**9/16" Screw Slot**

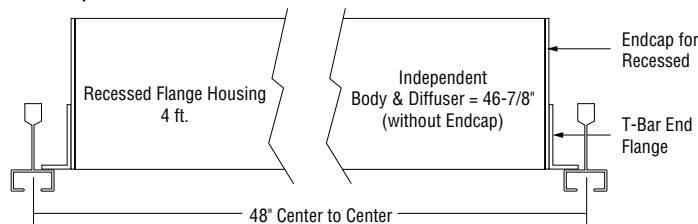

## HARD CEILING LENGTH DETAIL - 4' EXAMPLE

**Spackle Flange**

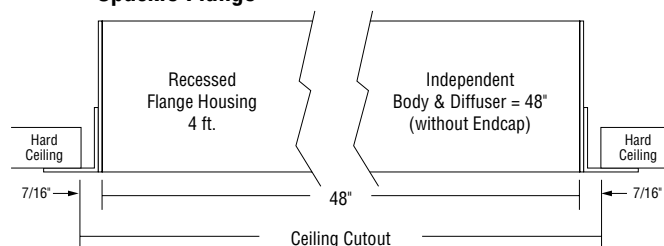

**Visible Flange**

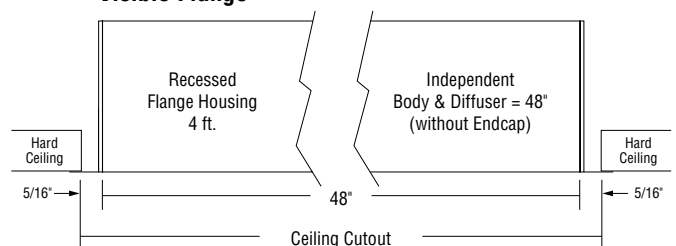



|                |          |       |
|----------------|----------|-------|
| Submitted by:  |          | Date: |
| Type:          | Project: |       |
| Ordering Info: |          |       |

# High Performance 2" Aperture (HP-2) Recessed

## RECESSED MOUNTING TYPES - T-BAR

Rough-In Dimensions

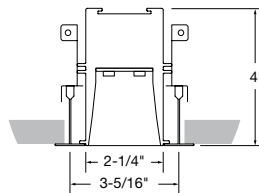

15/16" T-Bar (C1)

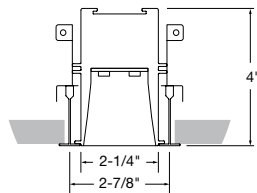

9/16" T-Bar (C2)

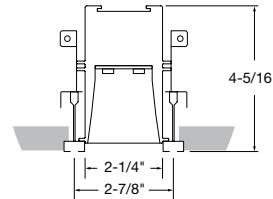

Standard Screw Slot (C3)

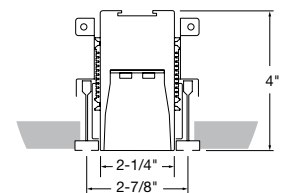

Flush Screw Slot (C3F)

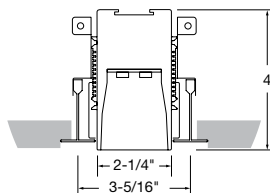

15/16" Tegular (C1T)

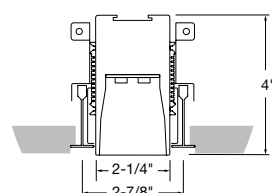

9/16" Tegular (C2T)

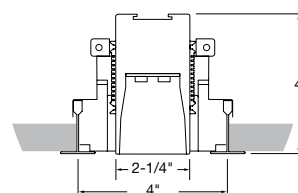

Tech Zone 4" (TZ4)  
15/16" T-Bar (C1)

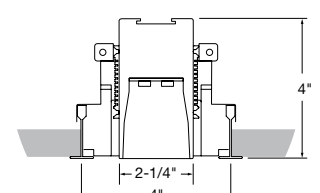

Tech Zone 4" (TZ4)  
9/16" T-Bar (C2)

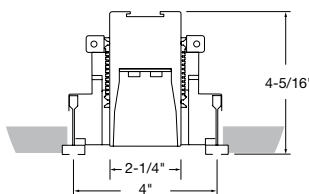

Tech Zone 4" (TZ4)  
Standard Screw Slot (C3)

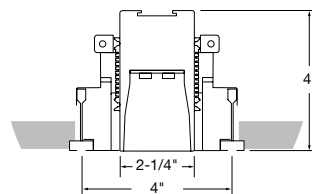

Tech Zone 4" (TZ4)  
Flush Screw Slot (C3F)

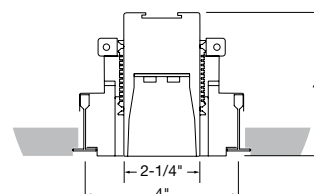

Tech Zone 4" (TZ4)  
9/16" Tegular (C2T)

## RECESSED MOUNTING TYPES - CUTOUT DIMENSIONS

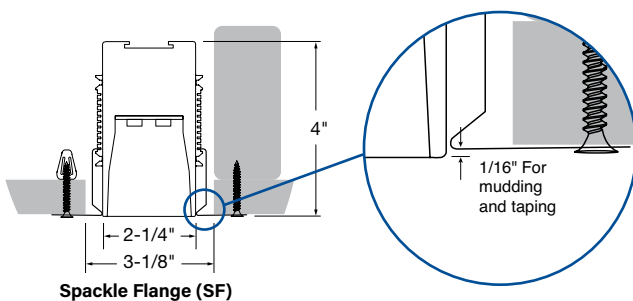

Spackle Flange (SF)

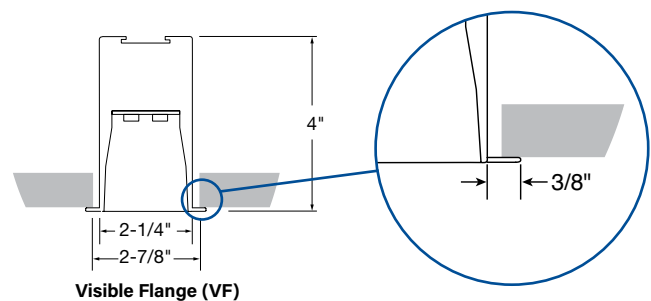

Visible Flange (VF)

## HOUSING

Version 1

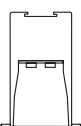

Ceiling Option VF

Version 2

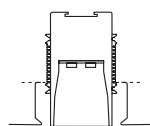

Ceiling Options  
C1T, C2T, C3F, SF, TZ4

Version 3

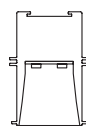

Ceiling Options  
C1, C2, C3

Note: +/- 1/16"

|                |          |       |
|----------------|----------|-------|
| Submitted by:  |          | Date: |
| Type:          | Project: |       |
| Ordering Info: |          |       |

# High Performance 2" Aperture (HP-2) Recessed

## REGRESSED MOUNTING TYPES - T-BAR

Rough-In Dimensions

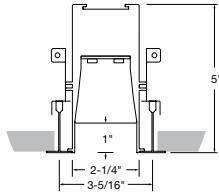

15/16" T-Bar (C1)

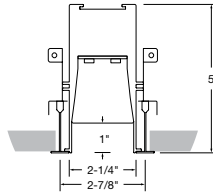

9/16" T-Bar (C2)

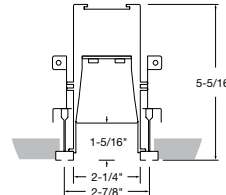

Standard Screw Slot (C3)

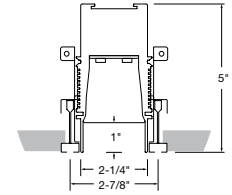

Flush Screw Slot (C3F)

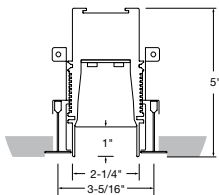

15/16" Tegular (C1T)

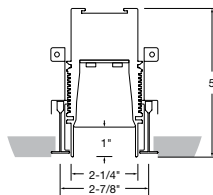

9/16" Tegular (C2T)

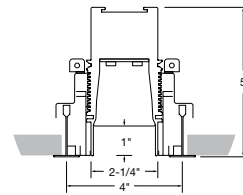

Tech Zone 4" (TZ4)  
15/16" T-Bar (C1)

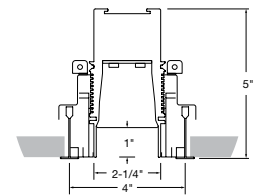

Tech Zone 4" (TZ4)  
9/16" T-Bar (C2)

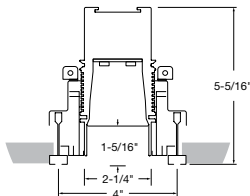

Tech Zone 4" (TZ4)  
Standard Screw Slot (C3)

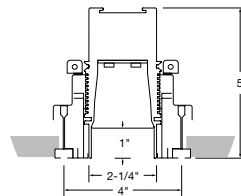

Tech Zone 4" (TZ4)  
Flush Screw Slot (C3F)

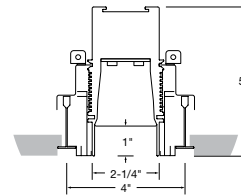

Tech Zone 4" (TZ4)  
9/16" Tegular (C2T)

## REGRESSED MOUNTING TYPES - CUTOUT DIMENSIONS

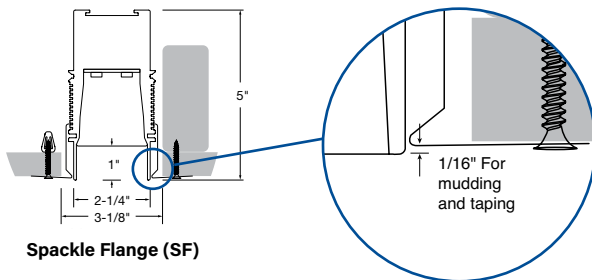

Spackle Flange (SF)

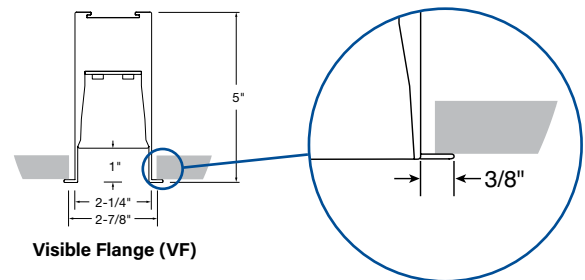

Visible Flange (VF)

**Regressed Lens:** Regressed lens version is 5" tall with a lens that is regressed 1" from ceiling line.

## HOUSING

Version 1

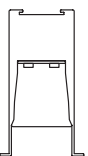

Ceiling Option VF

Version 2

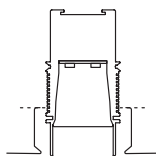

Ceiling Options  
C1T, C2T, C3F, SF, TZ4

Version 3

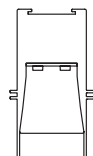

Ceiling Options  
C1, C2, C3

Note: +/- 1/16"

|                |          |       |
|----------------|----------|-------|
| Submitted by:  |          | Date: |
| Type:          | Project: |       |
| Ordering Info: |          |       |

# High Performance 2" Aperture (HP-2) Recessed

## Recessed Photometry - 4' Luminaire 3500K

### HP2-R-D-4'-V-835-DAO

**Downlight:** Downlight Asymmetric Optic - Right

**Efficacy:** 105 lm/W

**Total luminaire output:** 3741 lumens (935 lm/ft)  
35.5 watts (8.9 W/ft)

**Peak Candela Value:** 1670 @ 0°

CRI: 80 / CCT: 3500K

ITL LM79 Report REP-051921-01

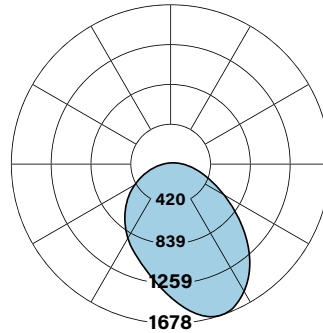

### HP2-R-D-4'-V-835-DSO

**Downlight:** Downlight Spread Optic

**Efficacy:** 92 lm/W

**Total luminaire output:** 3273 lumens (818 lm/ft)  
35.7 watts (8.9 W/ft)

**Peak Candela Value:** 1197 @ 0°

CRI: 80 / CCT: 3500K

ITL LM79 Report 94139

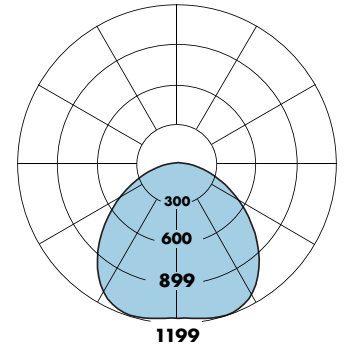

#### Total Light Output, 3500K, 80 CRI (Lumens) - 4' Luminaire

| S <sup>1</sup> | B <sup>1</sup> | H <sup>1</sup> | V <sup>2</sup> |
|----------------|----------------|----------------|----------------|
| 1531           | 1925           | 2910           | 3741           |

#### Light Output, 3500K, 80 CRI (Lumens Per Foot)

| S <sup>1</sup> | B <sup>1</sup> | H <sup>1</sup> | V <sup>2</sup> |
|----------------|----------------|----------------|----------------|
| 383            | 481            | 727            | 935            |

#### Power, 3500K (Watts Per Foot)

| S <sup>1</sup> | B <sup>1</sup> | H <sup>1</sup> | V <sup>2</sup> |
|----------------|----------------|----------------|----------------|
| 3.5            | 4.4            | 6.8            | 8.9            |

#### Efficacy, 3500K, 80 CRI (Lumens Per Watt)

| S <sup>1</sup> | B <sup>1</sup> | H <sup>1</sup> | V <sup>2</sup> |
|----------------|----------------|----------------|----------------|
| 110            | 109            | 107            | 105            |

S - Standard Output, B - Boosted Standard Output, H - High Output, V - Very High Output

<sup>1</sup> Family Correlation based on 4' luminaire 3500K Very High Output (V) test - 120V.

<sup>2</sup> Based on ITL report: REP-051921-01

#### Total Light Output, 3500K, 80 CRI (Lumens) - 4' Luminaire

| S <sup>1</sup> | B <sup>1</sup> | H <sup>1</sup> | V <sup>2</sup> |
|----------------|----------------|----------------|----------------|
| 1340           | 1684           | 2546           | 3273           |

#### Light Output, 3500K, 80 CRI (Lumens Per Foot)

| S <sup>1</sup> | B <sup>1</sup> | H <sup>1</sup> | V <sup>2</sup> |
|----------------|----------------|----------------|----------------|
| 335            | 421            | 636            | 818            |

#### Power, 3500K (Watts Per Foot)

| S <sup>1</sup> | B <sup>1</sup> | H <sup>1</sup> | V <sup>2</sup> |
|----------------|----------------|----------------|----------------|
| 3.5            | 4.4            | 6.8            | 8.9            |

#### Efficacy, 3500K, 80 CRI (Lumens Per Watt)

| S <sup>1</sup> | B <sup>1</sup> | H <sup>1</sup> | V <sup>2</sup> |
|----------------|----------------|----------------|----------------|
| 96             | 95             | 93             | 92             |

S - Standard Output, B - Boosted Standard Output, H - High Output, V - Very High Output

<sup>1</sup> Family Correlation based on 4' luminaire 3500K Very High Output (V) test - 120V.

<sup>2</sup> Based on ITL report: 94139

Wattage is Real Power. If you would like additional details to calculate Apparent Power, please contact your local Finelite representative.

### Sample Lumen Adjustment Calculation

| Lumen Adjustment Factors 80 CRI |       |
|---------------------------------|-------|
| 3000K                           | 0.985 |
| 3500K                           | 1.000 |
| 4000K                           | 1.032 |

| Lumen Adjustment Factors 90 CRI |       |
|---------------------------------|-------|
| 3000K                           | 0.746 |
| 3500K                           | 0.760 |
| 4000K                           | 0.789 |

High Output (H) / 4000K, 90 CRI  
**Lumen Adjustment Factor:** 0.789  
**Total Light Output:** 2910 lm x 0.789 = 2296 lm  
**Total Light Output per Foot:** 707 lm/ft x 0.789 = 574 lm/ft.  
**watts/foot:** 6.8 W/ft.

$$\text{Efficacy} = \frac{574 \frac{\text{lm}}{\text{ft.}}}{6.8 \frac{\text{W}}{\text{ft.}}} = 84 \text{ lm/W}$$

|                |          |       |
|----------------|----------|-------|
| Submitted by:  |          | Date: |
| Type:          | Project: |       |
| Ordering Info: |          |       |

# High Performance 2" Aperture (HP-2) Recessed

## Recessed Photometry - 4' Luminaire 3500K

**HP2-R-D-4'-V-835**  
Downlight: Flush Diffuser

**Efficacy:** 89 lm/W  
**Total luminaire output:** 3287 lumens (822 lm/ft)  
36.9 watts (9.2 W/ft)  
**Peak Candela Value:** 1335 @ 0°  
CRI: 80 / CCT: 3500K  
ITL LM79 Report 85135

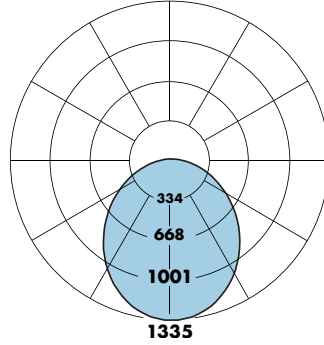

**HP2-R RG-D-4'-V-835**  
Downlight: Regressed Diffuser

**Efficacy:** 79 lm/W  
**Total luminaire output:** 2907 lumens (727 lm/ft)  
37 watts (9.3 W/ft)  
**Peak Candela Value:** 1554 @ 0°  
CRI: 80 / CCT: 3500K  
ITL LM79 Report 90351

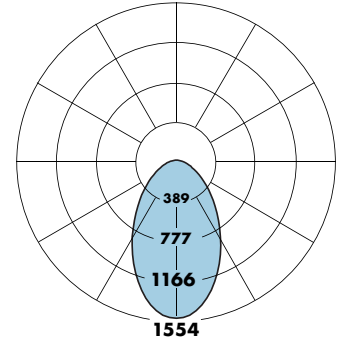

### Total Light Output, 3500K, 80 CRI (Lumens) - 4' Luminaire

| S <sup>1</sup> | B <sup>1</sup> | H <sup>1</sup> | V <sup>2</sup> |
|----------------|----------------|----------------|----------------|
| 1346           | 1692           | 2557           | 3287           |

### Light Output, 3500K, 80 CRI (Lumens Per Foot)

| S <sup>1</sup> | B <sup>1</sup> | H <sup>1</sup> | V <sup>2</sup> |
|----------------|----------------|----------------|----------------|
| 336            | 423            | 639            | 822            |

### Power, 3500K (Watts Per Foot)

| S <sup>1</sup> | B <sup>1</sup> | H <sup>1</sup> | V <sup>2</sup> |
|----------------|----------------|----------------|----------------|
| 3.6            | 4.6            | 7.1            | 9.2            |

### Efficacy, 3500K, 80 CRI (Lumens Per Watt)

| S <sup>1</sup> | B <sup>1</sup> | H <sup>1</sup> | V <sup>2</sup> |
|----------------|----------------|----------------|----------------|
| 93             | 92             | 90             | 89             |

### Total Light Output, 3500K, 80 CRI (Lumens) - 4' Luminaire

| S <sup>1</sup> | B <sup>1</sup> | H <sup>1</sup> | V <sup>2</sup> |
|----------------|----------------|----------------|----------------|
| 1190           | 1496           | 2261           | 2907           |

### Light Output, 3500K, 80 CRI (Lumens Per Foot)

| S <sup>1</sup> | B <sup>1</sup> | H <sup>1</sup> | V <sup>2</sup> |
|----------------|----------------|----------------|----------------|
| 298            | 374            | 565            | 727            |

### Power, 3500K (Watts Per Foot)

| S <sup>1</sup> | B <sup>1</sup> | H <sup>1</sup> | V <sup>2</sup> |
|----------------|----------------|----------------|----------------|
| 3.6            | 4.6            | 7.1            | 9.3            |

### Efficacy, 3500K, 80 CRI (Lumens Per Watt)

| S <sup>1</sup> | B <sup>1</sup> | H <sup>1</sup> | V <sup>2</sup> |
|----------------|----------------|----------------|----------------|
| 82             | 81             | 80             | 79             |

S - Standard Output, B - Boosted Standard Output, H - High Output, V - Very High Output

<sup>1</sup> Family Correlation based on 4' luminaire 3500K Very High Output (V) test - 120V.

<sup>2</sup> Based on ITL report: 85135

S - Standard Output, B - Boosted Standard Output, H - High Output, V - Very High Output

<sup>1</sup> Family Correlation based on 4' luminaire 3500K Very High Output (V) test - 120V.

<sup>2</sup> Based on ITL report: 90351

Wattage is Real Power. If you would like additional details to calculate Apparent Power, please contact your local Finelite representative.

### Sample Lumen Adjustment Calculation

| Lumen Adjustment Factors 80 CRI |       |
|---------------------------------|-------|
| 3000K                           | 0.985 |
| 3500K                           | 1.000 |
| 4000K                           | 1.032 |

| Lumen Adjustment Factors 90 CRI |       |
|---------------------------------|-------|
| 3000K                           | 0.746 |
| 3500K                           | 0.760 |
| 4000K                           | 0.789 |

High Output (H) / 4000K, 90 CRI  
**Lumen Adjustment Factor:** 0.789  
**Total Light Output:** 2557 lm x 0.789 = 2017 lm  
**Total Light Output per Foot:** 639 lm/ft x 0.789 = 504 lm/ft.  
**watts/foot:** 71 W/ft.

$$\text{Efficacy} = \frac{504 \frac{\text{lm}}{\text{ft.}}}{7.1 \frac{\text{W}}{\text{ft.}}} = 71 \text{ lm/W}$$

|                |          |       |
|----------------|----------|-------|
| Submitted by:  |          | Date: |
| Type:          | Project: |       |
| Ordering Info: |          |       |

# High Performance 2" Aperture (HP-2) Recessed

## Wall Wash Recessed - 4' Luminaire 3500K

**HP2-R-WW-D-K-4'-V-835**

**Downlight:** With Kicker

**Efficacy:** 76 lm/W

**Total luminaire output:** 1500 lumens (375 lm/ft)  
19.6 watts (4.9 W/ft)

**Peak Candela Value:** 882 @ 25°

CRI: 80 / CCT: 3500K

ITL LM79 Report 85137

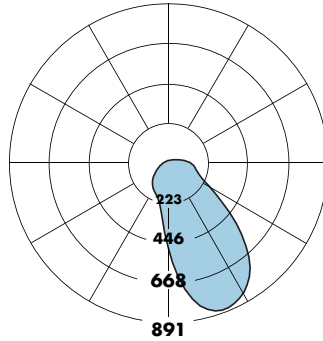

### Total Light Output, 3500K, 80 CRI (Lumens) - 4' Luminaire

| S <sup>1</sup> | B <sup>1</sup> | H <sup>1</sup> | V <sup>2</sup> |
|----------------|----------------|----------------|----------------|
| 614            | 772            | 1167           | 1500           |

### Light Output, 3500K, 80 CRI (Lumens Per Foot)

| S <sup>1</sup> | B <sup>1</sup> | H <sup>1</sup> | V <sup>2</sup> |
|----------------|----------------|----------------|----------------|
| 154            | 193            | 292            | 375            |

### Power, 3500K (Watts Per Foot)

| S <sup>1</sup> | B <sup>1</sup> | H <sup>1</sup> | V <sup>2</sup> |
|----------------|----------------|----------------|----------------|
| 2.0            | 2.5            | 3.8            | 4.9            |

### Efficacy, 3500K, 80 CRI (Lumens Per Watt)

| S <sup>1</sup> | B <sup>1</sup> | H <sup>1</sup> | V <sup>2</sup> |
|----------------|----------------|----------------|----------------|
| 76             | 77             | 77             | 77             |

S - Standard Output, B - Boosted Standard Output, H - High Output, V - Very High Output

<sup>1</sup> Family Correlation based on 4' luminaire 3500K Very High Output (V) test - 120V.

<sup>2</sup> Based on ITL report: 85137

Wattage is Real Power. If you would like additional details to calculate Apparent Power, please contact your local Finelite representative.

### Sample Lumen Adjustment Calculation

| Lumen Adjustment Factors 80 CRI |       |
|---------------------------------|-------|
| 3000K                           | 0.985 |
| 3500K                           | 1.000 |
| 4000K                           | 1.032 |

| Lumen Adjustment Factors 90 CRI |       |
|---------------------------------|-------|
| 3000K                           | 0.746 |
| 3500K                           | 0.760 |
| 4000K                           | 0.789 |

High Output (H) / 4000K, 90 CRI  
**Lumen Adjustment Factor:** 0.789  
**Total Light Output:** 1167 lm x 0.789 = 921 lm  
**Total Light Output per Foot:** 292 lm/ft x 0.789 = 230 lm/ft.  
**watts/foot:** 3.8 W/ft.

$$\text{Efficacy} = \frac{292 \frac{\text{lm}}{\text{ft.}}}{3.8 \frac{\text{W}}{\text{ft.}}} = 61 \text{ lm/W}$$

|                |          |       |
|----------------|----------|-------|
| Submitted by:  |          | Date: |
| Type:          | Project: |       |
| Ordering Info: |          |       |

# High Performance 2" Aperture (HP-2) Recessed

## WALL WASH RECESSED - SETBACK INFO AND APPLICATION DATA

**HP2-R-WW-D-K-4'-V-835**

**Downlight:** With Kicker

**Total luminaire output:** 1500 lumens (375 lm/ft)  
19.6 watts (4.9 W/ft)

CRI: 80 / CCT: 3500K

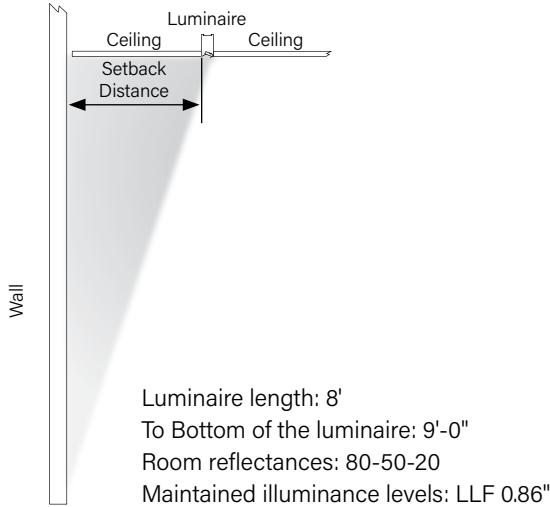

Setback Distance - 2'

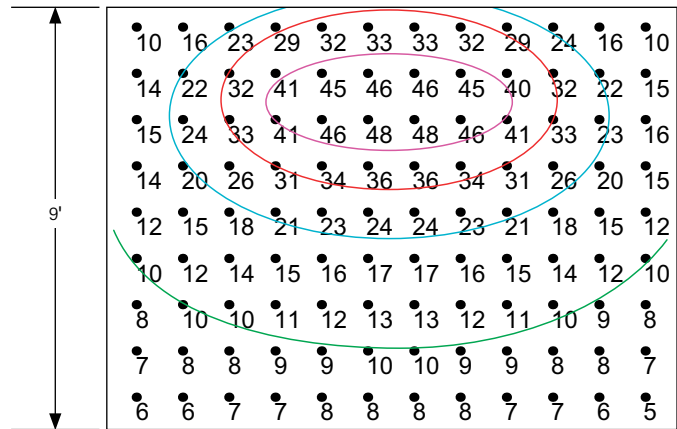

## DOWNLIGHT ASYMMETRIC OPTIC - SETBACK INFO AND APPLICATION DATA

**HP2-R-D-4ft-V-835-DAO**

**Downlight:** DAO

**Total luminaire output:** 3742 lumens (936 lm/ft)  
35.6 watts (8.9 W/ft)

CRI: 80 / CCT: 3500K

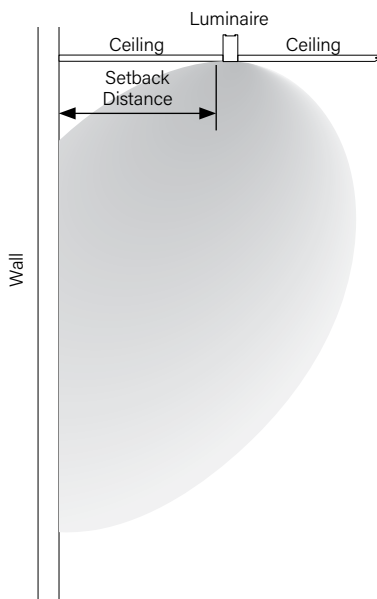

Setback Distance - 2'

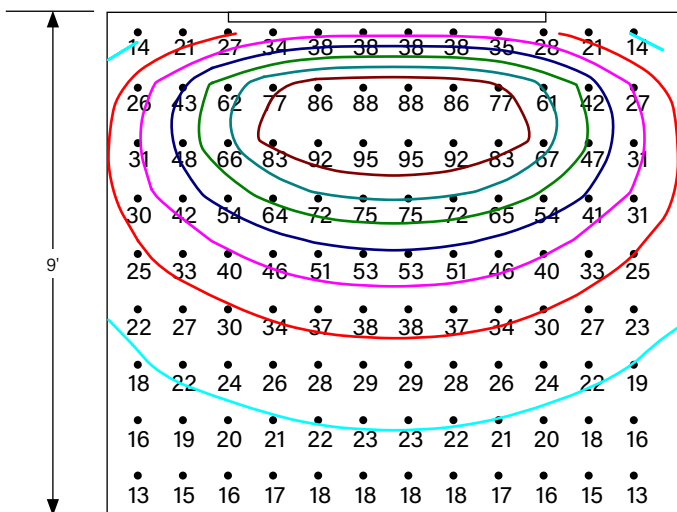

|                |          |       |
|----------------|----------|-------|
| Submitted by:  |          | Date: |
| Type:          | Project: |       |
| Ordering Info: |          |       |

# 0-10V Tunable White

Finelite's award-winning, contractor friendly Tunable White luminaires are available at low cost, with powerful and simple 0-10V tuning and intensity controls.

## TUNABLE WHITE FEATURES

- CCT range: 2700K - 6500K
- Dimming Range: 100% to 10%
- CRI Options: 80 CRI or 90 CRI

## LUMINAIRE FAMILY MODIFICATIONS/RESTRICTIONS

| Recessed Direct                    | Section Lengths  |    |    |    |    |    |    |    |     |     |     |  |
|------------------------------------|--|----|----|----|----|----|----|----|-----|-----|-----|--|
|                                    | 2'   | 3' | 4' | 5' | 6' | 7' | 8' | 9' | 10' | 11' | 12' |  |
| Output S,B,H,V Single Circuit      | Rows can be comprised of 2'-12' sections.<br>Tailored lengths available. |    |    |    |    |    |    |    |     |     |     |  |
| Integral Battery Backup (BSL310LP) |  |    |    |    |    |    |    |    |     |     |     |  |

## PHOTOMETRY

Apply a power adjustment factor to calculate wattage usage

| POWER | CONVERSION FACTOR |
|-------|-------------------|
|       | <b>1.1X</b>       |

(Example: a 50 watt luminaire in static white would draw 55 watts using 0-10V Tunable White)

## WIRING DIAGRAM - DIMMABLE TO 10%

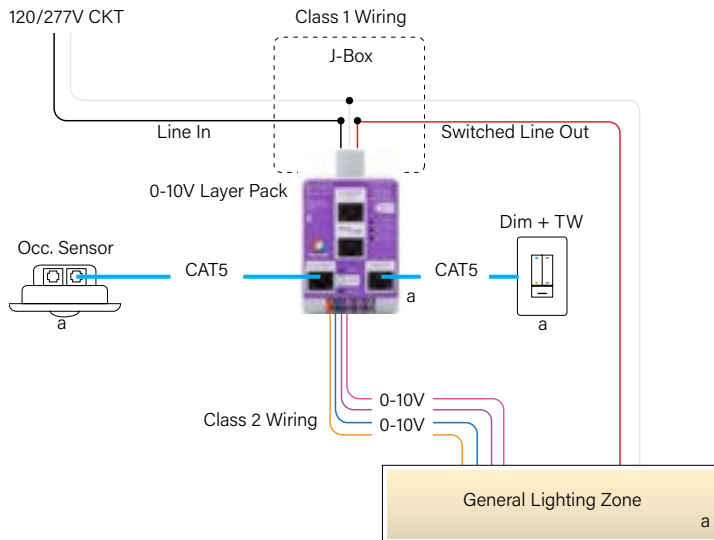

### Luminaire Wiring

- **Purple (+) / Pink (-)** control wires are for intensity control
- **Orange (+) / Blue (-)** control wires are for Tunable White control

### Note:

Load or Dim to Off options available.

## DUAL FEED DETAIL

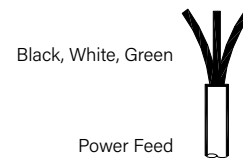

| WIRING LEGEND |         |              |
|---------------|---------|--------------|
| <b>Black</b>  | Hot     | Line Voltage |
| <b>White</b>  | Neutral | Line Voltage |
| <b>Green</b>  | Ground  |              |

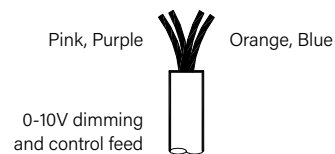

| WIRING LEGEND |         |          |
|---------------|---------|----------|
| <b>Pink</b>   | Dimming | 0-10V DC |
| <b>Purple</b> | Dimming | 0-10V DC |
| <b>Orange</b> | TW      | 0-10V DC |
| <b>Blue</b>   | TW      | 0-10V DC |

