

Submitted by:		Date:
Type:	Project:	
Ordering Info:		

High Performance 4" Aperture (HP-4) Pendant

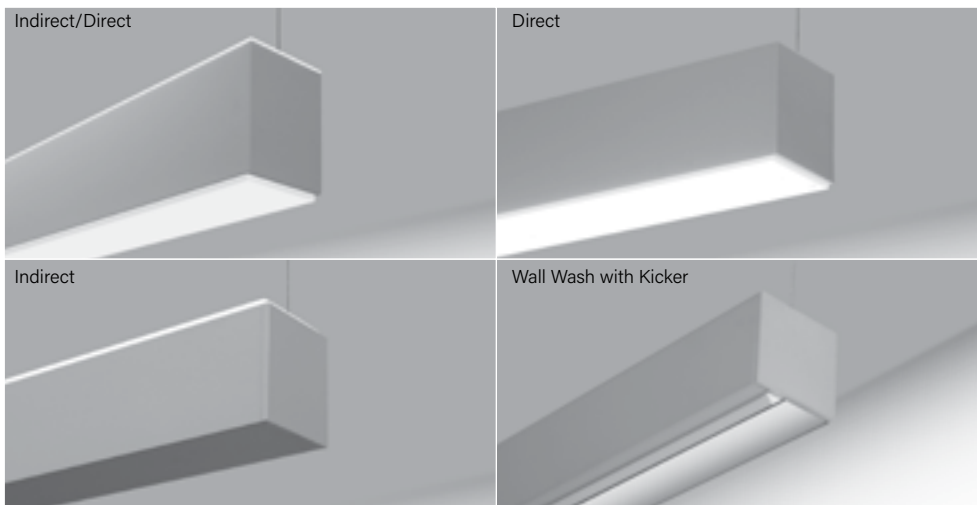

High Performance 4" Aperture is a patented, linear LED luminaire family. HP-4 delivers excellent performance using an advanced optical design and mid-power LEDs. Achieving 90% of initial light output at 100,000+ hours and backed by a 10-year performance-based warranty on all standard components.

This product is enrolled in the International Living Future Institute (ILFI) Declare 2.0 Program and is third-party verified with options achieving **Red List Approved** and **Red List Declared** status.

Signal White is standard finish

Note: see page 6 for all aesthetic options

CROSS SECTIONS

Indirect/Direct

Top Glow Diffuser (standard)

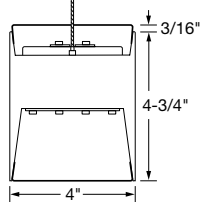

Flush Downlight Diffuser (standard)

Direct

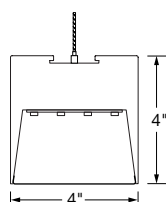

Flush Downlight Diffuser (standard)

Indirect

Top Glow Diffuser (standard)

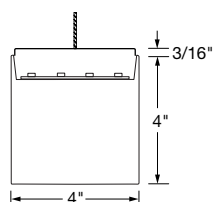

Wall Wash Direct

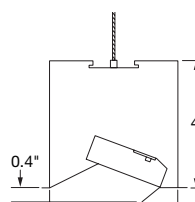

Kicker (standard)

Top Glow Diffuser (standard)

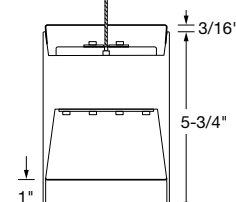

Flat Diffuser with 1" Regressed (standard)

Regressed Direct

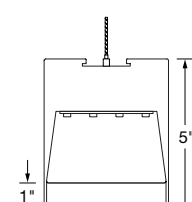

Flat Diffuser with 1" Regressed (standard)

OPTIC OPTIONS

Widespread & Widespread Top Glow (WSO / WSO-TG)

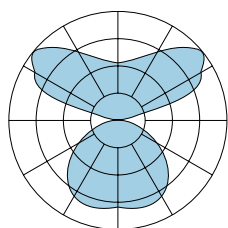

Downlight Spread Optic (DSO)

Asymmetric (ASY)

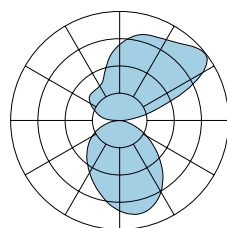

Downlight Asymmetric Optic (DAO)

Standard Uplight Flush Optic (F)

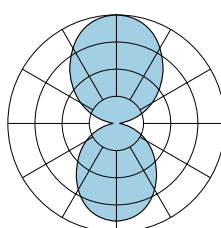

Standard Downlight Flush Optic (F)

ALSO AVAILABLE IN

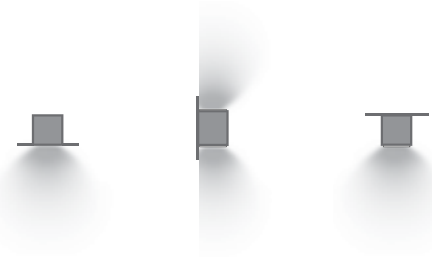

Recessed (R)

Wall Mount (WM)

Surface Mount (SM)



Declare.



Submitted by:		Date:
Type:	Project:	
Ordering Info:		

High Performance 4" Aperture (HP-4) Pendant

Ordering Guide Example: HP - 4 - P - ID - 36" - S - S - 835 - F - F - 96LG - 120 - DC - FC-10% - FA50 - C1 - FE - SW - LGD18W - OBO - CP

BODY TYPE

OUTPUT AND LED TYPE

Platform	Series Name	Luminaire Type	Luminaire Distribution	Total Length of Run	Uplight Output ID & I Only (Flush)	Downlight Output ID & D Only (Flush) ¹
HP - High Performance	4	P - Pendant PRG - Pendant Regressed ¹ (Wall Wash not available)	D - Direct WW-D - Wall Wash Direct ID - Indirect/Direct I - Indirect	Minimum 2' section length. Increments accurate to 1/16" (±1/32"), standard. 12' maximum section length.	S - Standard (428 lm/ft) B - Boosted (538 lm/ft) H - High (813 lm/ft) V - Very High (1045 lm/ft) TL - Tailored: _____ lm/ft*	S - Standard (379 lm/ft) B - Boosted (477 lm/ft) H - High (721 lm/ft) V - Very High (927 lm/ft) TL - Tailored: _____ lm/ft*

Lumen provided above are for Flush lens only, see pg. 11 for WW lumens.
 * Specify Tailored lm/ft of outputs between Standard (S) and Very High (V). Consult factory for tailored lumen output outside of this range.

OUTPUT AND LED TYPE

MECHANICAL/OPTICAL OPTIONS

ELECTRICAL OPTIONS

LED CRI/CCT	Uplight Optics ID & I Only	Downlight Optics ID & D Only ¹	Reflector System	Voltage
830 - 80 CRI, 3000K	TG - Top Glow (standard)	F - Flush (standard) ²	96LG - 96 Low Gloss White	120 - 120 Voltage
835 - 80 CRI, 3500K	F - Flush	BG - Bottom Glow ²	SSA - Semi-Specular Aluminum for Wall Wash only	277 - 277 Voltage
840 - 80 CRI, 4000K	ASY-L - Asymmetric Left Optic	DL - 1" Drop Down Lens ²		347 - 347 Voltage
930 - 90 CRI, 3000K	ASY-R - Asymmetric Right Optic	DAO-L - Downlight Asymmetric Optic Left ^{2,3}		
935 - 90 CRI, 3500K	ASYTG-L - Asymmetric Left Optic with Top Glow	DAO-R - Downlight Asymmetric Optic Right ^{2,3}		
940 - 90 CRI, 4000K	ASYTG-R - Asymmetric Right Optic with Top Glow	DSO - Downlight Spread Optic ^{2,3}		
8TW - 80 CRI, Tunable White	WSO - Widespread Optic	FO - Fully Open for Wall Wash only		
9TW - 90 CRI, Tunable White	WSOTG - Widespread Optic with Top Glow	K - Kicker for Wall Wash only (standard) ⁴		
		RG-D - Flat Diffuser with 1" Regress ^{2,5}		
		RG-WCB - White Cross Blade Baffle ^{2,5}		
		RG-LHE - Hollowed Ellipse Louver ^{2,5}		
		RG-LHC - Hex Louver ^{2,5}		

Circuiting⁶

- SC** - Single Circuit*
One single circuit in a run
- DC** - Dual Circuit*⁷
Independent control of up and down separately in an I/D style fixture
- MC** - Multi-Circuit*
More than one switch leg or zone. Factory shop drawings required

* Battery, Night Light, and Emergency to Generator circuits are in addition to the normal luminaire circuit(s)

ELECTRICAL OPTIONS

MOUNTING OPTIONS

OTHER OPTIONS

Driver Selection	Mounting Method	Endcap Style	Finish
0-10V Driver Options FC-10% - 0-10V 10% (standard) FC-1% - 0-10V 1% OTI-10% - EldoLED OTI, 0-10V 10% ⁸ OTI-1% - EldoLED OTI, 0-10V 1% ⁹ ELD-10V-0% - EldoLED SOLOdrive, 0-10V 0.1% 10V-TW-10% - EldoLED OTI, 0-10V 10% (Tunable White) ⁸ DALI Driver Options FC-DALI-1% - DALI 1% DXL-DALI-1% - EldoLED Dexal, 1% ELD-DALI-0% - EldoLED SOLOdrive, 0.1% ELD-DALI-TW - EldoLED DUALdrive LightShape, 0.1% (Tunable White)	Lutron Driver Options LUT-ES1 - Lutron, Ecosystem 1% LUT-TW - Lutron T-Series, EcoSystem 0.1% (Tunable White) See Page 3 for additional driver options and details	FA50 - Fully Adjustable 50" (standard) FA100 - Fully Adjustable 100" FA150 - Fully Adjustable 150" FA200 - Fully Adjustable 200" FA250 - Fully Adjustable 250" FA300 - Fully Adjustable 300" FM - Flexible Mounting ¹⁰ Ceiling Hardware Type C1 - 15/16" T-Bar C2 - 9/16" T-Bar C3 - Screw Slot C4 - Hard Ceiling C1T - 15/16" Tegular C2T - 9/16" Tegular	FE - Flat Endcap (standard) DE - 1" Drop Endcap ¹¹ OE - Open Endcap ¹² SW - Signal White (standard) FB - Finelite Black SA - Satin Aluminum #### - RAL Color Code ¹³

OTHER OPTIONS

Emergency Style (Optional) <small>See page 5 Backup Battery table</small>	Integrated Sensor (Optional)	Special Options (Optional)
LGD18W - Legrand 18W Brand Battery Back-up LGD10W - Legrand 10W Brand Battery Back-up BSL722 - Bodine Battery Back up BSL310LP - Bodine Battery Back up Low Profile EM/GEN - Emergency to Generator NL - Night Light GTD - Generator Transfer Device ALCR - Automatic Load Control Relay See Backup Battery table on page 5 for fitment limitations	OBO - Occupancy ² OBD - Daylight ² W601 - Wattstopper Sensor ¹⁴ OBE - Enlighted Sensor ¹⁵ REE - Remote Enlighted ¹⁶ CLM-99 - Encelium RF SLM-99 - Encelium Sensor	AOCC-W - Lutron Athena Sensor ¹⁷ (Device Color White) AOCC-B - Lutron Athena Sensor ¹⁷ (Device Color Black) ARF-W - Lutron Athena RF ¹⁷ (Device Color White) ARF-B - Lutron Athena RF ¹⁷ (Device Color Black) VOCC - Lutron Vive Sensor ¹⁸ VRF - Lutron Vive RF ¹⁸ CP - Chicago Plenum ¹⁹ RLA - Red List Approved RLD - Red List Declared

¹ Not available with Indirect

² Not available with Wall Wash

³ Not available with Regressed or Curves

⁴ Kicker standard in Signal White. Customer Custom color kickers have a surcharge

⁵ Pendant Regressed only

⁶ Contact factory for switching options

⁷ Indirect/Direct only

⁸ Add DTO to gain "Dim to Off" functionality (FC-10% - DTO, FC-1% - DTO)

⁹ B & V outputs only

¹⁰ Direct only

¹¹ 1" Drop Down Lens downlight only

¹² Available with Hollowed Ellipse Louver (LHE) only

¹³ 20 business days lead time for color

¹⁴ LMFS-601 w/ 0-10V driver(s) and LMFI-111, up to 6 drivers may be connected.

¹⁵ LMFS-601 w/ DALI driver, only 1 driver can be connected.

¹⁶ Enlighted components installed by Finelite, provided by others

¹⁷ Enlighted for Wall Wash fixtures. Enlighted Control Unit & Sensor Cable installed for Remote mounting sensor

¹⁸ 0-10V Drivers - **AOCC** up to 10 drivers may be connected; **ARF** up to 40 drivers may be connected

DALI Drivers - **AOCC** & **ARF** up to 4 drivers can be connected

¹⁹ Lutron Vive Integrated Sensors require a DALI driver. Contact factory for Indirect Distribution.

²⁰ Only available with C1, C2, and C3 mounting hardware with Finelite Gridbox

Submitted by:		Date:
Type:	Project:	
Ordering Info:		

High Performance 4" Aperture (HP-4) Pendant

SUPPLEMENTARY DRIVER PAGE

0-10V Driver Options

FC-10%	Factory Choice, 0-10V 10% Dimming (Linear)
FC-10%-DTO	Factory Choice, 0-10V 10% Dimming, Dim-to-Off (Linear)
FC-1%	Factory Choice, 0-10V 1% Dimming (Linear)
FC-1%-DTO	Factory Choice, 0-10V 1% Dimming, Dim-to-Off (Linear)
ELD-10V-0%	EldoLED SOLOdrive, 0-10V 0.1% Dimming (Linear)
ELD-10V-1%	EldoLED ECOdrive, 0-10V 1% Dimming (Linear)
10V-TW-10%	EldoLED OTi, 0-10V 10% Dimming, Tunable White (Linear)
10V-TW-10%-DTO	EldoLED OTi, 0-10V 10% Dimming, Dim-to-Off, Tunable White (Linear)
OTi-10%	EldoLED OTi, 0-10V 10% Dimming (Linear)
OTi-10%-DTO	EldoLED OTi, 0-10V 10% Dimming, Dim-to-Off (Linear)
OTi-1%	EldoLED OTi, 0-10V 1% Dimming (Linear)
OTi-1%-DTO	EldoLED OTi, 0-10V 1% Dimming, Dim-to-Off (Linear)

DALI Driver Options

FC-DALI-1%	Factory Choice, DALI 1% Dimming (Logarithmic)
ODXL-DALI-1%	EldoLED Dexal, DALI 1% Dimming (Logarithmic)
ELD-DALI-0%	EldoLED SOLOdrive, DALI 0.1% Dimming (Logarithmic)
ELD-DALI-1%	EldoLED ECOdrive, DALI 1% Dimming (Logarithmic)
ELD-DALI-TW	EldoLED DUALdrive Light Shape, DALI 0.1% Dimming, Tunable White (Logarithmic Dimming, Linear CCT Control)

Lutron Driver Options

LUT-ES1	Lutron, Ecosystem 1% Dimming
LUT-TW	Lutron T-Series, EcoSystem 0.1% Dimming, Tunable White

Submitted by:		Date:
Type:	Project:	
Ordering Info:		

High Performance 4" Aperture (HP-4) Pendant

SPECIFICATIONS

BODY TYPE

CONSTRUCTION: Precision-cut 6063-T6 extruded aluminum body. Internal joiner system, plug-together wiring, standard.

LENGTHS: Any length, 2' minimum, in increments down to 1/16" (±1/32"). 12' maximum section length. Hollowed Ellipse Louver (**LHE**), Hex Louver (**LHC**), and White Cross Blade Baffle (**WCB**) are available in 1' increments.

MITERED CORNERS¹: Illuminated corners of greater than 60° and less than 180° in a single plane, available with Flush Diffuser, Bottom Glow Diffuser, Regressed Diffuser, or White Cross Blade Baffle³. Corners not available with Wall Wash (**WW-D**), Hollowed Ellipse Louver (**LHE**), Hex Louver (**LHC**), or 1" Drop Down Lens. Consult factory for tailored lighting options.

OUTPUT AND LED TYPE

LIGHT OUTPUT: Four lumen packages available, Standard (**S**), Boosted Standard (**B**), High (**H**), and Very High (**V**). For lengths 3' and greater, the uplight and downlight can be specified with different lumen packages and dual controls. For Tailored Outputs outside of range from Standard (**S**) to Very High (**V**), consult factory. Light engines are replaceable.

MECHANICAL/OPTICAL OPTIONS

UPLIGHT OPTION⁴: Patented Top Glow frost white diffuser standard. 12 ft. maximum diffuser length. 73% transmissive, 99% diffusion. Internal secondary diffusers at corners ensure visually seamless, uniform, continuous illumination options include: Flush frost white snap-in diffuser, 73% transmissive, 99% diffusion; Widespread Optic (**WSO**) and Widespread Optic with Top Glow (**WSOTG**); WSO enables increased luminaire spacing with improved ceiling uniformity. Asymmetric optic directs light in a specific direction. **ASY-L** distributes light to the left, **ASY-R** distributed light to the right of the luminaire. Consult factory for more tailored lumen outputs.

DOWNLIGHT OPTION⁵: 12' maximum diffuser length. Flush frost white snap-in diffuser standard, 77% transmissive, 99% diffusion. Internal secondary diffusers at corners ensure visually seamless, uniform, continuous illumination. Available with Flush (**F**), Bottom Glow (**BG**), 1" Drop Down Lens (**DL**), White Cross Blade Baffle (**WCB**)⁶, Hollowed Ellipse Louver (**LHE**)⁶, Hex Louver (**LHC**)⁶, Downlight Spread Optic (**DSO**), Downlight Asymmetric Optic Left and Right (**DAO-L**, **DAO-R**), and Regressed downlight diffusers (**RG**)⁶. 1" Drop Down Lens made of acrylic. Available with a solid endcap or an endcap with a diffuse filler to continue the luminous aesthetic. Downlight Spread Optic (**DSO**) & Downlight Asymmetric Optic (**DAO**) are an extruded lenses with a subtle ribbed appearance providing desired improved optical performance. Consult factory for more tailored lumen outputs.

LUMEN MAINTENANCE: 90% of initial light output (L90) at 100,000+ hours; 70% of initial light output (L70) at 200,000+ hours.

REFLECTORS: Die-formed 20-gauge cold-rolled steel reflectors finished in 96LG High Reflectance white powder coat paint. The standard Semi-Specular Aluminum (**SSA**) Kicker (**K**) reflector delivers light high on the vertical surface. The Kicker reflector can be easily removed for open distribution (**FO**).

ELECTRICAL OPTIONS

STATIC WHITE FEED: Standard with one 18-gauge/5-conductor single-circuit feed controlling uplight and downlight together (power and dimming). Specify dual feeds for independent control of uplight and downlight. 14-gauge feed used when luminaire current exceeds 5 amps.

TUNABLE WHITE FEED: Standard with one 18-gauge/5-conductor single-circuit feed. 14-gauge feed used when fixture current exceeds 5 amps.

STATIC WHITE DRIVER: Replaceable 120V, 277V, and 347V constant current reduction dimming driver standard. Can be wired dimming or non-dimming. 0-10V dimming controls with a range of 100%-10% standard. Dimming to 1% available. Separate dimming for uplight and downlight available. Driver is fully accessible from below the ceiling.

Power Factor: ≥ 0.9

Total Harmonic Distortion (THD): <20%

Expected driver lifetime: 100,000 hours

LUTRON DRIVER OPTIONS:

LUT-ES (LDE1) - (Hi-lume 1% EcoSystem with Soft-On, Fade-to-Black dimming (LDE1 series))

TUNABLE WHITE DRIVER: Replaceable LED driver. Driver is accessible from below the ceiling. 120V, 277V, and 347V.

- **Power factor:** ≥0.90

- **Total Harmonic Distortion (THD):** <20%

- **Dimming Range:** 100%-10%

- **Expected driver lifetime:** 100,000 hours

LUTRON TUNABLE WHITE DRIVER OPTION: LUT-TW (0.1% T-Series 2-Channel Digital Tunable White (PSQ Series)).

MOUNTING OPTIONS

HANGING HARDWARE: 50" Fully Adjustable (**FA**) steel-plated aircraft cable with safety stop hardware standard. The Flexible Mounting Bracket (**FM**) adjusts the suspension points to accommodate existing architecture. Suspension points adjust up to 2' in from the end of 8' or 12' fixture lengths and up to 1' in on shorter lengths. Consult factory for tailored lighting options.

¹ Not available with Wall Wash

² Indirect/Direct and Direct only

³ White Cross Blade (WCB) baffles not available with custom angles. Available in 90 degrees only

⁴ Pendant Indirect/Direct, Pendant Regressed Indirect/Direct, and Pendant Indirect only

⁵ Pendant Indirect/Direct, Pendant Regressed Indirect/Direct, Pendant Direct, and Pendant Regressed Direct only

⁶ Pendant Regressed Indirect/Direct & Pendant Regressed Direct only

Submitted by:		Date:
Type:	Project:	
Ordering Info:		

High Performance 4" Aperture (HP-4) Pendant

SPECIFICATIONS

TUNABLE WHITE HANGING HARDWARE: For grid ceiling applications the dual GridBox™ mounting is supplied (standard). For hard ceiling applications the ceiling mounting box is supplied (standard).

TUNABLE WHITE INTERCONNECTION CABLES: Luminaires are pre-wired with plug-and-play interconnection cables to support easy plug-together joining of fixture runs.

OTHER OPTIONS

ENDCAPS: Flat diecast aluminum endcaps (**FE**) add 1/4" to each end of luminaire. 1" Drop Down Lens Endcap (**DE**)⁸ includes diffuse element to continue luminance of drop lens. Open Endcap (**OE**) is for use with the Hollowed Ellipse Louver (**LHE**); following the curve of the louver.

EMERGENCY STYLE: Optional emergency to generator/inverter wiring, internal generator transfer switch, nightlight wiring, step- dimming driver, backup battery.

Backup Battery

	Legrand 18W	Legrand 10W/ Bodine BSL310LP
HP4-P-D		
Min. Housing Length	8'	4'
EM Lumen Output	1854	1102
EM Section Illum.	2'	2' or 4'
HP4-P-WW-D		
Min. Housing Length	8' [*]	4' [*]
EM Lumen Output	2000	1189
EM Section Illum.	4'	4'
HP4-P-ID		
Min. Housing Length	8'	4'
EM Lumen Output	1854	1102
EM Section Illum.	2'	2' or 4'
HP4-P-I		
Min. Housing Length	8'	4'
EM Lumen Output	2057	1222
EM Section Illum.	2'	2' or 4'

^{*} Minimum fixture housing length for battery pack approved without sensor

The lumens are based on 835. For other CCT/CRI, refer to the Lumen Adjustment Factor table on page 9.

Bodine GTD and Legrand ALCR Min. Length

Configuration	Min Length
Generator	D-2'; ID-3'
Generator + OCC	D-2'; ID-3'
Daylight	D-2'; ID-3'
Generator + Daylight	D-2'; ID-3'

TW Driver Options 0-10V: EM/GEN, GTD or Battery Back up

DALI: EM/GEN, GTD or Battery Back up

LUTRON: EM/GEN, GTD or Battery Back up

INTEGRATED SENSORS: Integrated PIR (Passive Infrared) Occupancy (**OBO**) or Daylight Sensors (**OBD**) available with Flush and Bottom Glow downlight diffusers. PIR sensors not recommended for stairwell applications. Refer to Occupancy Sensor & Daylight Sensor tech sheet and the Embedded Intelligence landing page for more information and additional sensor options.

FINISHES: Finelite Signal White (**SW**) powder coat, Finelite Black (RAL 9005) with semi gloss fine texture (**FB**), and Satin Aluminum (**SA**) are standard. Optional Adder: 179 RAL colors¹⁰ are available.

LABELS: Luminaire and electrical components are ETL-listed conforming to UL 1598 in the U.S.A. and CAN/CSA C22.2 No. 250.0 in Canada. In accordance with NEC Code 410.130 (G), this luminaire contains an internal driver disconnect. UL 924 and UL 2108 - PoE options available on request. These fixtures are rated for Damp Location. Chicago Plenum options available for C1, C2, or C3 suspension using our GridBox. Finelite products use electronic components that are RoHS compliant, and the mechanical components of the luminaire have been verified to not knowingly contain any restricted substances listed per RoHS Directive 2015/863. Consult factory for tailored lighting options. Finelite makes the specification process easy when putting healthier products on your projects. Simply add – **RLA** (Red List Approved) or – **RLD** (Red List Declared) to your part number.

WEIGHT¹¹: ID - 3.4 lb/ft; D - 2.8 lb/ft; I - 2.8 lb/ft; WW - 2.9 lb/ft

DLC QUALIFIED: Contact factory

WARRANTY: 10-year performance-based warranty on all standard components. Optional accessories such as emergency battery packs are covered by their individual manufacturer warranties.

⁸ Available in Indirect/Direct Regressed & Direct Regressed only
⁹ Consult Finelite for Generator Transfer Device and Battery Backup fit
¹⁰ 20 business days lead time for color
¹¹ Excludes Battery Backup and Generator Transfer Device weight

Submitted by:		Date:
Type:	Project:	
Ordering Info:		

High Performance 4" Aperture (HP-4) Pendant

AESTHETIC OPTIONS

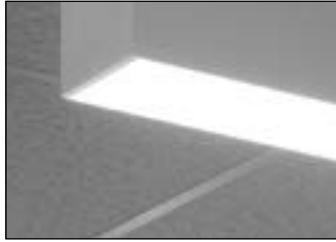

Flush Diffuser (**F**)

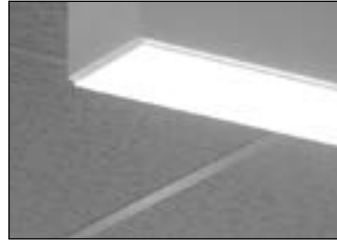

Bottom Glow Diffuser (**BG**)

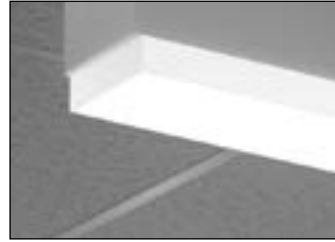

1" Drop Down Lens (**DL**)

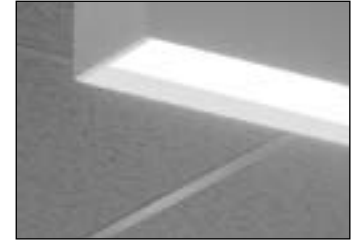

Flat Diffuser with 1" Regressed (**RG-D**)

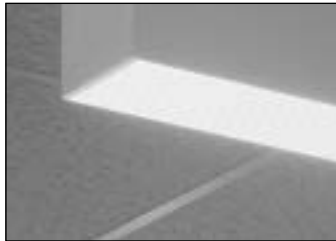

Downlight Spread Optic (**DSO**)
Externally flush

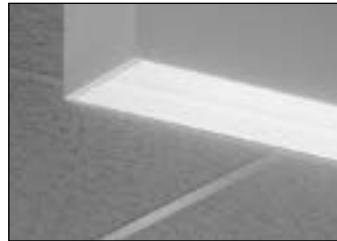

Downlight Asymmetric Optic (**DAO**)
Externally flush

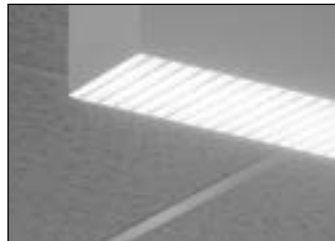

White Cross Blade Baffle¹ (**RG-WCB**)

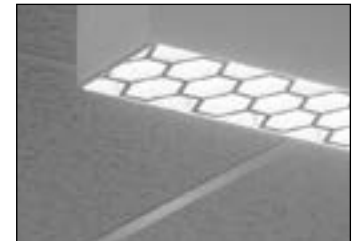

Hex Louver¹ (**RG-LHC**)



Hollowed Ellipse Louver¹ (**RG-LHE**)

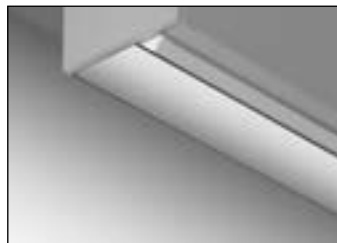

Kicker (**K**) - Wall Wash only

¹ Available for Regressed

Submitted by:		Date:
Type:	Project:	
Ordering Info:		

High Performance 4" Aperture (HP-4) Pendant

ASYMMETRIC OPTIONS

The diagrams below show a linear run from power feed to ender. Specifying ASY-L distributes light to the left or ASY-R distributes light to the right. For proper orientation: view luminaire from starter end when specifying the direction of the Asymmetric optic.

Asymmetric Left Optic (ASY-L)

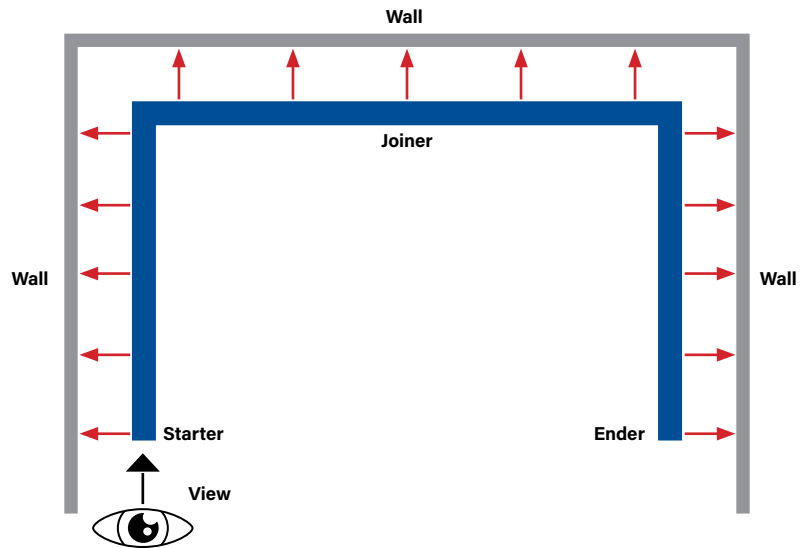
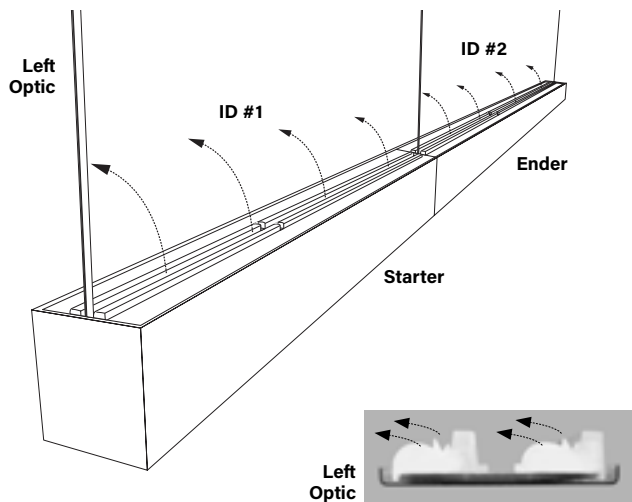

Asymmetric Right Optic (ASY-R)

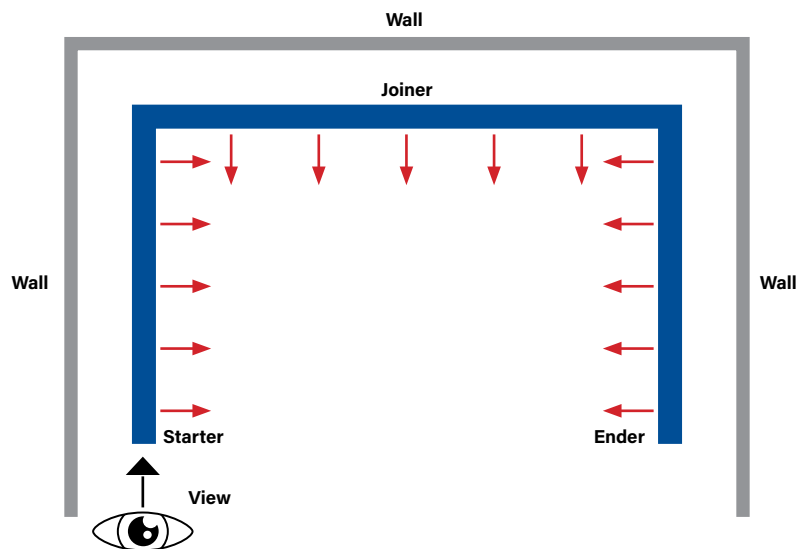
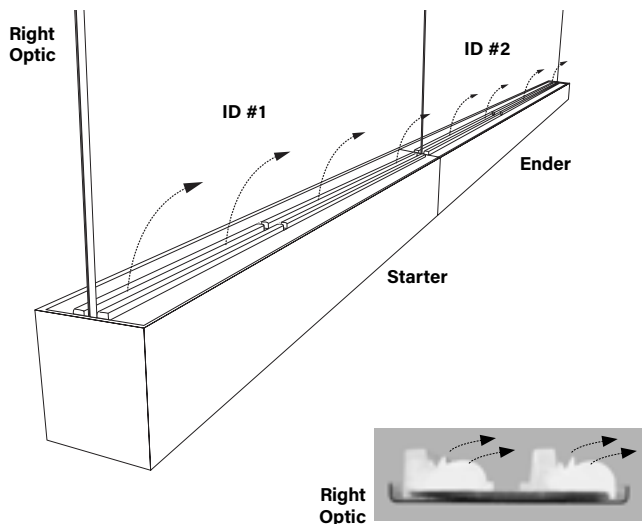

Submitted by:		Date:
Type:	Project:	
Ordering Info:		

High Performance 4" Aperture (HP-4) Pendant

DOWNLIGHT ASYMMETRIC OPTIONS

The diagrams below show a linear run from power feed to ender. Specifying DAO-L distributes light to the left or DAO-R distributes light to the right. For proper orientation: view luminaire from starter end when specifying the direction of the Downlight Asymmetric optic.

Downlight Asymmetric Optic Left (DAO-L)

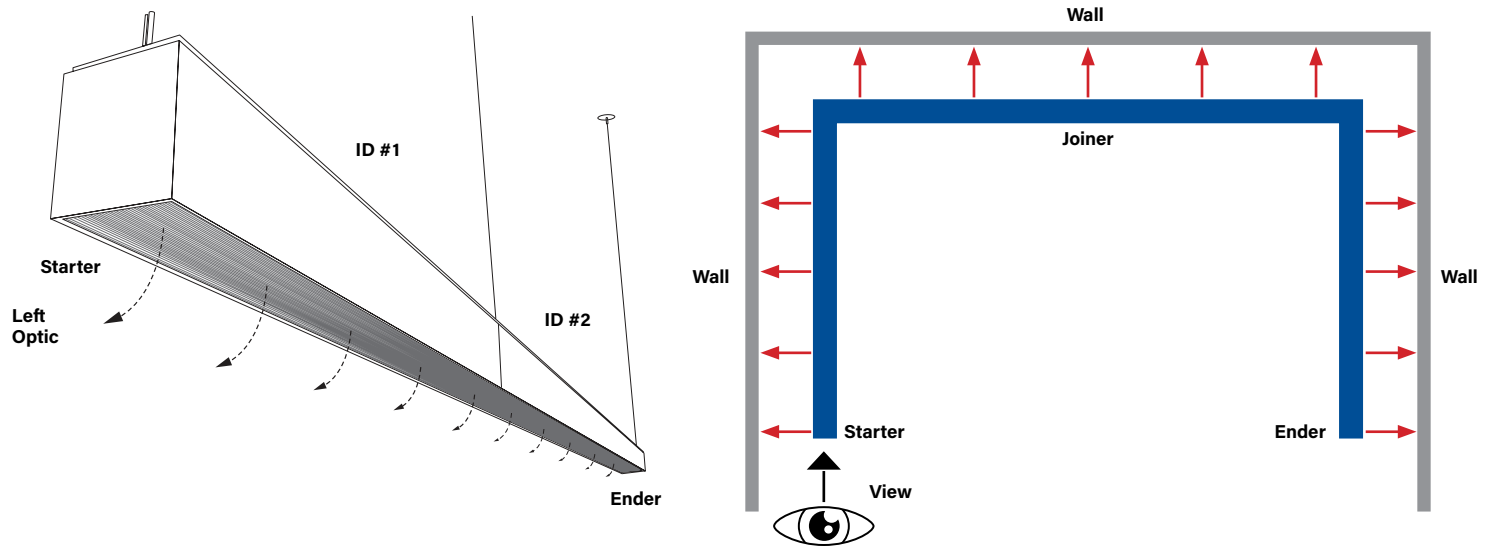

Downlight Asymmetric Optic Right (DAO-R)

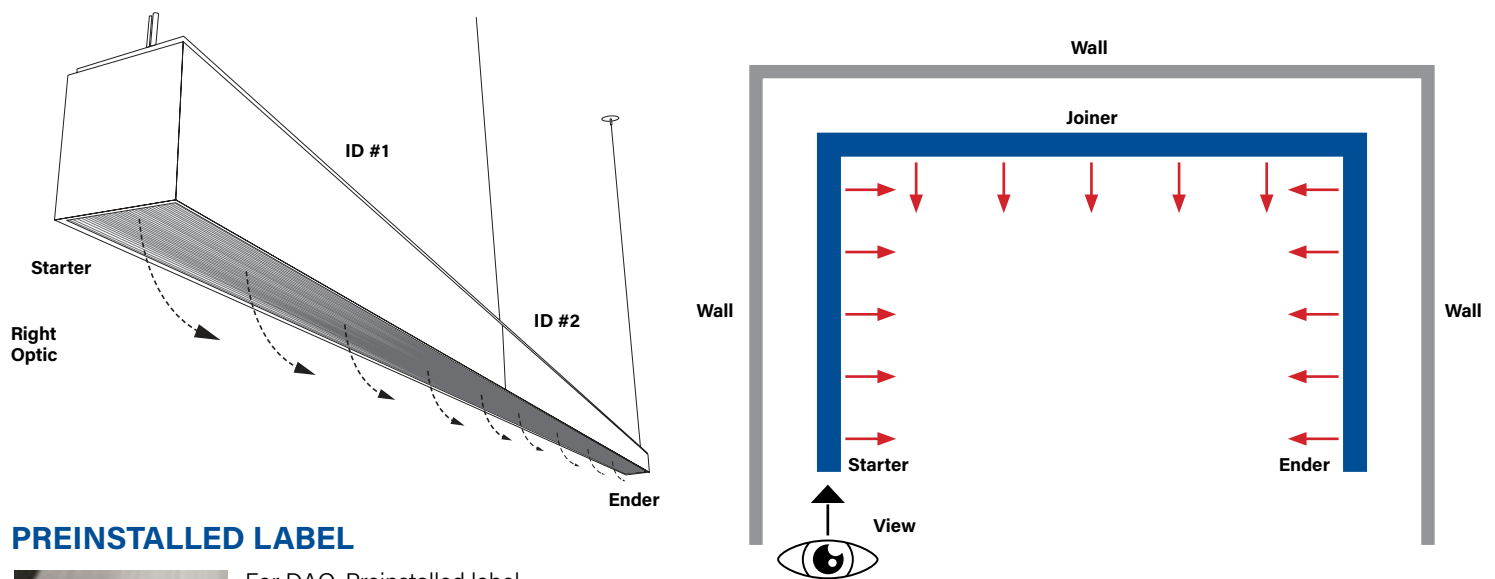

PREINSTALLED LABEL



For DAO, Preinstalled label on diffuser shows direction of light. Remove after installation.

Submitted by:		Date:
Type:	Project:	
Ordering Info:		

High Performance 4" Aperture (HP-4) Pendant

Indirect/Direct Photometry - 4' Luminaire 3500K

HP4-P-ID-4'-V-V-835-ASY-L-DAO

Uplight: Asymmetric Left / **Downlight:** Downlight Asymmetric Optic

Distribution: 53% Up (V) / 47% Down (V)
Efficacy: 115 lm/W
Uplight: 4436 lumens (1108 lumens/foot)
Downlight: 3884 lumens (971 lumens/foot)
Total luminaire output: 8320 lumens (2080 lm/ft)
72.5 watts (18.1 W/ft)

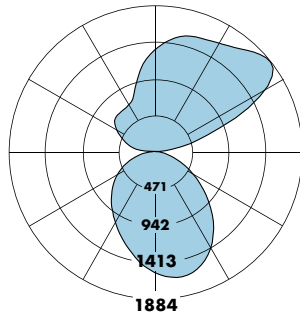

CRI: 80 / CCT: 3500K
ITL LM79 Report 89988 and 94331

HP4-P-ID-4'-V-V-835

Uplight: Flush Diffuser / **Downlight:** Flush Diffuser

Distribution: 53% Up (V) / 47% Down (V)
Efficacy: 106 lm/W
Uplight: 4180 lumens (1045 lumens/foot)
Downlight: 3706 lumens (927 lumens/foot)
Total luminaire output: 7886 lumens (1972 lm/ft)
74.1 watts (18.5 W/ft)

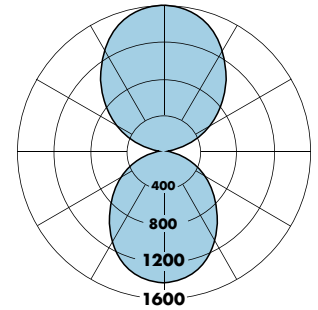

Peak Candela Value: 1600 @ 180°
CRI: 80 / CCT: 3500K
ITL LM79 Report 85125

Total Light Output, 3500K, 80 CRI (Lumens) - 4' Luminaire

	1S ¹	1B ¹	1H ¹	1V ²
1S ¹	3406 [153% 47%↓]	3873 [159% 41%↓]	5040 [169% 31%↓]	6026 [174% 26%↓]
1B ¹	3815 [147% 52%↓]	4282 [153% 47%↓]	5449 [163% 37%↓]	6435 [169% 31%↓]
1H ¹	4837 [138% 62%↓]	5304 [143% 57%↓]	6471 [153% 47%↓]	7457 [160% 40%↓]
1V ²	5700 [132% 68%↓]	6167 [137% 63%↓]	7344 [147% 53%↓]	8320 [153% 47%↓]

Light Output, 3500K, 80 CRI (Lumens Per Foot)

	1S ¹	1B ¹	1H ¹	1V ²
1S ¹	851	968	1260	1506
1B ¹	954	1070	1362	1609
1H ¹	1209	1326	1618	1864
1V ²	1425	1542	1834	1995

Power, 3500K (Watts Per Foot)

	1S ¹	1B ¹	1H ¹	1V ²
1S ¹	7.1	8.1	10.5	12.6
1B ¹	8.1	9.0	11.5	13.6
1H ¹	10.5	11.5	13.9	16.0
1V ²	12.6	13.6	16.0	18.1

Efficacy, 3500K, 80 CRI (Lumens Per Watt)

	1S ¹	1B ¹	1H ¹	1V ²
1S ¹	120	120	120	120
1B ¹	118	119	119	119
1H ¹	115	116	116	116
1V ²	113	114	115	115

S - Standard Output, B - Boosted Standard Output, H - High Output, V - Very High Output

¹ Family Correlation based on 4' luminaire 3500K Very High Output (V) test - 120V.

² Based on ITL reports: 89988 and 94331

Total Light Output, 3500K, 80 CRI (Lumens) - 4' Luminaire

	1S ¹	1B ¹	1H ¹	1V ²
1S ¹	3228 [153% 47%↓]	3668 [159% 41%↓]	4768 [168% 32%↓]	5697 [173% 27%↓]
1B ¹	3618 [147% 53%↓]	4058 [153% 47%↓]	5158 [163% 37%↓]	6087 [169% 31%↓]
1H ¹	4594 [137% 63%↓]	5034 [143% 57%↓]	6134 [153% 47%↓]	7062 [159% 41%↓]
1V ²	5417 [132% 68%↓]	5857 [137% 63%↓]	6957 [147% 53%↓]	7886 [153% 47%↓]

Light Output, 3500K, 80 CRI (Lumens Per Foot)

	1S ¹	1B ¹	1H ¹	1V ²
1S ¹	807	917	1192	1424
1B ¹	905	1015	1290	1522
1H ¹	1148	1258	1533	1766
1V ²	1354	1464	1739	1972

Power, 3500K (Watts Per Foot)

	1S ¹	1B ¹	1H ¹	1V ²
1S ¹	7.3	8.2	10.7	12.9
1B ¹	8.2	9.2	11.7	13.9
1H ¹	10.7	11.7	14.2	16.4
1V ²	12.9	13.9	16.4	18.5

Efficacy, 3500K, 80 CRI (Lumens Per Watt)

	1S ¹	1B ¹	1H ¹	1V ²
1S ¹	111	111	111	111
1B ¹	110	110	110	110
1H ¹	107	107	108	108
1V ²	105	106	106	106

S - Standard Output, B - Boosted Standard Output, H - High Output, V - Very High Output

¹ Family Correlation based on 4' luminaire 3500K Very High Output (V) test - 120V.

² Based on ITL reports: 85125

Wattage is Real Power. If you would like additional details to calculate Apparent Power, please contact your local Finelite representative.

Sample Lumen Adjustment Calculation

Lumen Adjustment Factors 80 CRI	
3000K	0.985
3500K	1.000
4000K	1.032

Lumen Adjustment Factors 90 CRI	
3000K	0.746
3500K	0.760
4000K	0.789

High Output (H) / Standard Output (S), 4000K, 90 CRI
Lumen Adjustment Factor: 0.789
Total Light Output: 4768 lm x 0.789 = 3762 lm
Total Light Output per Foot: 1192 lm/ft x 0.789 = 940 lm/ft.
watts/foot: 10.7 W/ft.

$$\text{Efficacy} = \frac{940 \frac{\text{lm}}{\text{ft.}}}{10.7 \frac{\text{W}}{\text{ft.}}} = 88 \text{ lm/W}$$

Submitted by:		Date:
Type:	Project:	
Ordering Info:		

High Performance 4" Aperture (HP-4) Pendant

Indirect/Direct Photometry - 4' Luminaire 3500K

HP4-P-RG-ID-4'-V-V-835

Uplight: Flush Diffuser / **Downlight:** Regressed Diffuser

Distribution: 56% Up (V) / 44% Down (V)

Efficacy: 108 lm/W

Uplight: 4406 lumens (1102 lumens/foot)

Downlight: 3531 lumens (883 lumens/foot)

Total luminaire output: 7937 lumens (1984 lm/ft)
73.2 watts (18.3 W/ft)

Peak Candela Value: 1656 @ 180°

CRI: 80 / CCT: 3500K

ITL LM79 Report 90353

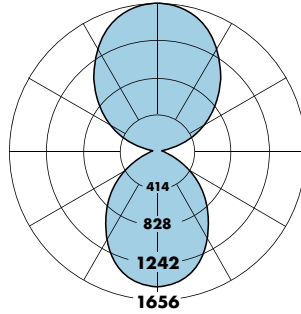

Total Light Output, 3500K, 80 CRI (Lumens) - 4' Luminaire

	1S ¹	1B ¹	1H ¹	1V ²
↓S ¹	3406 [↑53% 47%↓]	3873 [↑59% 41%↓]	5040 [↑69% 31%↓]	6026 [↑74% 26%↓]
↓B ¹	3815 [↑47% 52%↓]	4282 [↑53% 47%↓]	5449 [↑63% 37%↓]	6435 [↑69% 31%↓]
↓H ¹	4837 [↑38% 62%↓]	5304 [↑43% 57%↓]	6471 [↑53% 47%↓]	7457 [↑60% 40%↓]
↓V ²	5700 [↑32% 68%↓]	6167 [↑37% 63%↓]	7344 [↑47% 53%↓]	8320 [↑53% 47%↓]

Light Output, 3500K, 80 CRI (Lumens Per Foot)

	1S ¹	1B ¹	1H ¹	1V ²
↓S ¹	851	968	1260	1506
↓B ¹	954	1070	1362	1609
↓H ¹	1209	1326	1618	1864
↓V ²	1425	1542	1834	1995

Power, 3500K (Watts Per Foot)

	1S ¹	1B ¹	1H ¹	1V ²
↓S ¹	7.1	8.1	10.5	12.6
↓B ¹	8.1	9.0	11.5	13.6
↓H ¹	10.5	11.5	13.9	16.0
↓V ²	12.6	13.6	16.0	18.1

Efficacy, 3500K, 80 CRI (Lumens Per Watt)

	1S ¹	1B ¹	1H ¹	1V ²
↓S ¹	120	120	120	120
↓B ¹	118	119	119	119
↓H ¹	115	116	116	116
↓V ²	113	114	115	115

S - Standard Output, B - Boosted Standard Output, H - High Output, V - Very High Output

¹ Family Correlation based on 4' luminaire 3500K Very High Output (V) test - 120V.

² Based on ITL reports: 90353

HP4-P-D-4'-V-835

Downlight: Flush Diffuser

Efficacy: 100 lm/W

Total luminaire output: 3705 lumens (926 lm/ft)
37 watts (9.3 W/ft)

Peak Candela Value: 1436 @ 0°

CRI: 80 / CCT: 3500K

ITL LM79 Report 85124

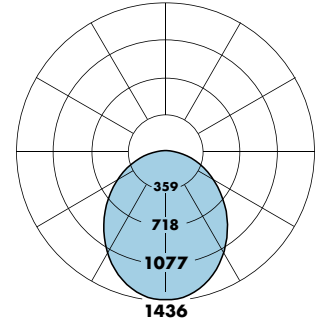

Total Light Output, 3500K, 80 CRI (Lumens) - 4' Luminaire

S ¹	B ¹	H ¹	V ²
1517	1907	2882	3705

Light Output, 3500K, 80 CRI (Lumens Per Foot)

S ¹	B ¹	H ¹	V ²
379	477	720	926

Power, 3500K (Watts Per Foot)

S ¹	B ¹	H ¹	V ²
3.6	4.6	7.1	9.3

Efficacy, 3500K, 80 CRI (Lumens Per Watt)

S ¹	B ¹	H ¹	V ²
105	107	102	100

S - Standard Output, B - Boosted Standard Output, H - High Output, V - Very High Output

¹ Family Correlation based on 4' luminaire 3500K Very High Output (V) test - 120V.

² Based on ITL reports: 90353

Wattage is Real Power. If you would like additional details to calculate Apparent Power, please contact your local Finelite representative.

Sample Lumen Adjustment Calculation

Lumen Adjustment Factors 80 CRI	
3000K	0.985
3500K	1.000
4000K	1.032

Lumen Adjustment Factors 90 CRI	
3000K	0.746
3500K	0.760
4000K	0.789

High Output (H) / Standard Output (S), 4000K, 90 CRI
Lumen Adjustment Factor: 0.789
Total Light Output: 4872 lm x 0.789 = 3844 lm
Total Light Output per Foot: 1218 lm/ft x 0.789 = 961 lm/ft.
watts/foot: 10.6 W/ft.

$$\text{Efficacy} = \frac{961 \frac{\text{lm}}{\text{ft.}}}{10.6 \frac{\text{W}}{\text{ft.}}} = 91 \text{ lm/W}$$

Submitted by:		Date:
Type:	Project:	
Ordering Info:		

High Performance 4" Aperture (HP-4) Pendant

Direct Photometry - 4' Luminaire 3500K

HP4-P-D-4'-V-835
Downlight: Flush Diffuser

Efficacy: 100 lm/W
Total luminaire output: 3705 lumens (926 lm/ft)
37 watts (9.3 W/ft)
Peak Candela Value: 1436 @ 0°
CRI: 80 / CCT: 3500K
ITL LM79 Report 85124

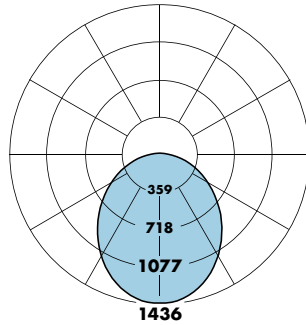

Total Light Output, 3500K, 80 CRI (Lumens) - 4' Luminaire			
S ¹	B ¹	H ¹	V ²
1517	1907	2882	3705

Light Output, 3500K, 80 CRI (Lumens Per Foot)			
S ¹	B ¹	H ¹	V ²
379	477	720	926

Power, 3500K (Watts Per Foot)			
S ¹	B ¹	H ¹	V ²
3.6	4.6	7.1	9.3

Efficacy, 3500K, 80 CRI (Lumens Per Watt)			
S ¹	B ¹	H ¹	V ²
105	107	102	100

S - Standard Output, B - Boosted Standard Output, H - High Output, V - Very High Output
¹ Family Correlation based on 4' luminaire 3500K Very High Output (V) test - 120V.
² Based on ITL reports: 85124

HP4-P-D-4'-V-835-DAO
Downlight: Downlight Asymmetric Optic

Efficacy: 109 lm/W
Total luminaire output: 3884 lumens (971 lm/ft)
35.6 watts (8.9 W/ft)
Peak Candela Value: 1645 @ 12.5°
CRI: 80 / CCT: 3500K
ITL LM79 Report 94331

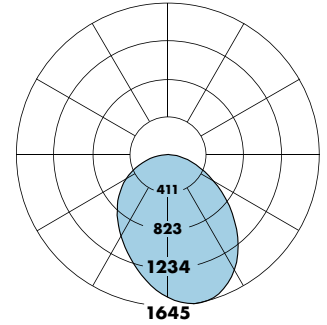

Total Light Output, 3500K, 80 CRI (Lumens) - 4' Luminaire			
S ¹	B ¹	H ¹	V ²
1590	1999	3021	3884

Light Output, 3500K, 80 CRI (Lumens Per Foot)			
S ¹	B ¹	H ¹	V ²
397	500	755	971

Power, 3500K (Watts Per Foot)			
S ¹	B ¹	H ¹	V ²
3.5	4.4	6.8	8.9

Efficacy, 3500K, 80 CRI (Lumens Per Watt)			
S ¹	B ¹	H ¹	V ²
114	113	111	109

S - Standard Output, B - Boosted Standard Output, H - High Output, V - Very High Output
¹ Family Correlation based on 4' luminaire 3500K Very High Output (V) test - 120V.
² Based on ITL reports: 94331

Wattage is Real Power. If you would like additional details to calculate Apparent Power, please contact your local Finelite representative.

Sample Lumen Adjustment Calculation

Lumen Adjustment Factors 80 CRI	
3000K	0.985
3500K	1.000
4000K	1.032

Lumen Adjustment Factors 90 CRI	
3000K	0.746
3500K	0.760
4000K	0.789

High Output (H), 4000K, 90 CRI
Lumen Adjustment Factor: 0.789
Total Light Output: 2882 lm x 0.789 = 2274 lm
Total Light Output per Foot: 720 lm/ft x 0.789 = 568 lm/ft.
watts/foot: 71 W/ft.

$$\text{Efficacy} = \frac{568 \frac{\text{lm}}{\text{ft.}}}{7.1 \frac{\text{W}}{\text{ft.}}} = 80 \text{ lm/W}$$

Submitted by:		Date:
Type:	Project:	
Ordering Info:		

High Performance 4" Aperture (HP-4) Pendant

Indirect Photometry - 4' Luminaire 3500K

HP4-P-I-4'-V-835

Uplight: Flush Diffuser

Efficacy: 112 lm/W

Total luminaire output: 4114 lumens (1029 lm/ft)
37 watts (9.2 W/ft)

Peak Candela Value: 1552 @ 180°

CRI: 80 / CCT: 3500K

ITL LM79 Report 85127

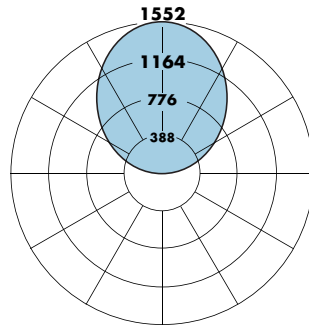

HP4-P-WW-D-K-4'-V-835

Downlight: With Kicker

Efficacy: 92 lm/W

Total luminaire output: 1816 lumens (454 lm/ft)
21.5 watts (5.4 W/ft)

Peak Candela Value: 1072 @ 35°

CRI: 80 / CCT: 3500K

ITL LM79 Report 85130

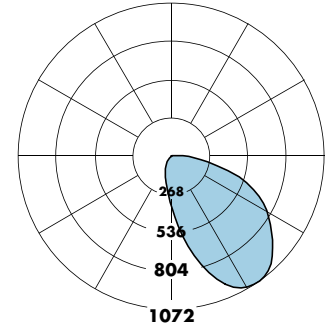

Total Light Output, 3500K, 80 CRI (Lumens) - 4' Luminaire

S ¹	B ¹	H ¹	V ²
1684	2117	3200	4114

Light Output, 3500K, 80 CRI (Lumens Per Foot)

S ¹	B ¹	H ¹	V ²
421	529	800	1029

Power, 3500K (Watts Per Foot)

S ¹	B ¹	H ¹	V ²
3.6	4.6	7.1	9.2

Efficacy, 3500K, 80 CRI (Lumens Per Watt)

S ¹	B ¹	H ¹	V ²
117	116	113	112

S - Standard Output, B - Boosted Standard Output, H - High Output, V - Very High Output

¹ Family Correlation based on 4' luminaire 3500K Very High Output (V) test - 120V.

² Based on ITL reports: 85127

Total Light Output, 3500K, 80 CRI (Lumens) - 4' Luminaire

S ¹	B ¹	H ¹	V ²
743	935	1412	1816

Light Output, 3500K, 80 CRI (Lumens Per Foot)

S ¹	B ¹	H ¹	V ²
186	234	353	454

Power, 3500K (Watts Per Foot)

S ¹	B ¹	H ¹	V ²
2.0	2.5	3.8	5.0

Efficacy, 3500K, 80 CRI (Lumens Per Watt)

S ¹	B ¹	H ¹	V ²
91	92	92	92

S - Standard Output, B - Boosted Standard Output, H - High Output, V - Very High Output

¹ Family Correlation based on 4' luminaire 3500K Very High Output (V) test - 120V.

² Based on ITL reports: 85130

Wattage is Real Power. If you would like additional details to calculate Apparent Power, please contact your local Finelite representative.

Sample Lumen Adjustment Calculation

Lumen Adjustment Factors 80 CRI	
3000K	0.985
3500K	1.000
4000K	1.032

Lumen Adjustment Factors 90 CRI	
3000K	0.746
3500K	0.760
4000K	0.789

High Output (H), 4000K, 90 CRI

Lumen Adjustment Factor: 0.789

Total Light Output: 2882 lm x 0.789 = 2274 lm

Total Light Output per Foot: 720 lm/ft x 0.789 = 568 lm/ft.

watts/foot: 71 W/ft.

$$\text{Efficacy} = \frac{568 \frac{\text{lm}}{\text{ft.}}}{7.1 \frac{\text{W}}{\text{ft.}}} = 80 \text{ lm/W}$$

Submitted by:		Date:
Type:	Project:	
Ordering Info:		

High Performance 4" Aperture (HP-4) Pendant

Wall Wash Direct - Setback Info and Application Data

HP4-P-WW-D-K-4'-V-835

Downlight: With Kicker

Total luminaire output: 1450 lumens (363 lm/ft)
19.1 watts (4.8 W/ft)

CRI: 80 / CCT: 3500K

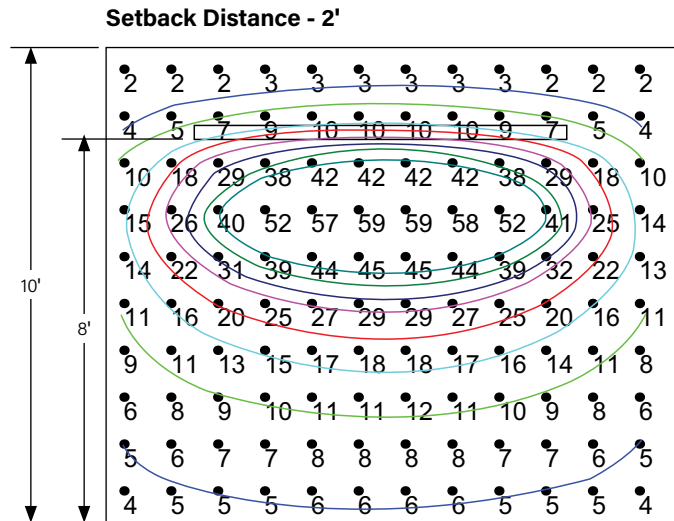
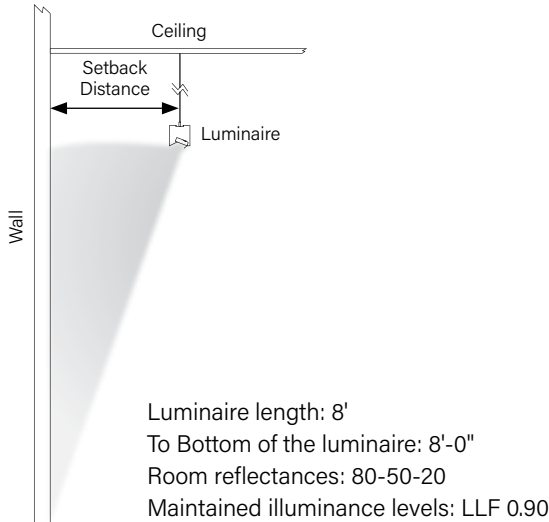

Downlight Asymmetric Optic - Setback Info and Application Data

HP4-P-D-4ft-V-835-DAO

Downlight: DAO

Total luminaire output: 3884 lumens (971 lm/ft)
35.6 watts (8.9 W/ft)

CRI: 80 / CCT: 3500K

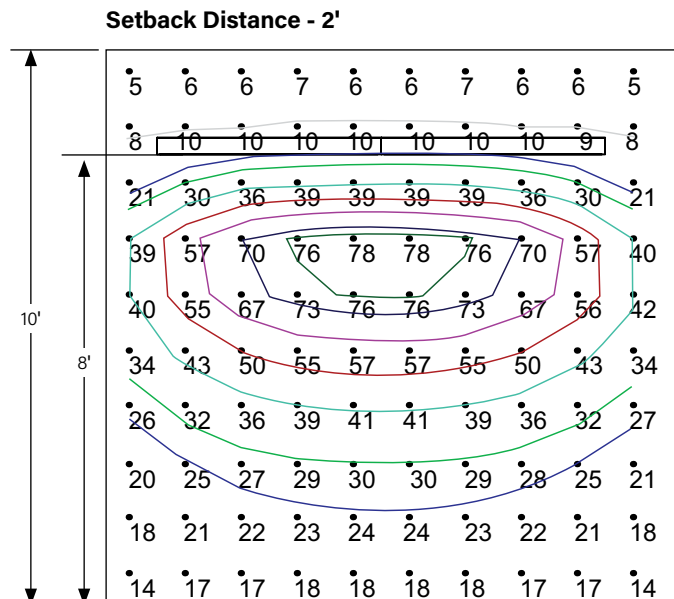
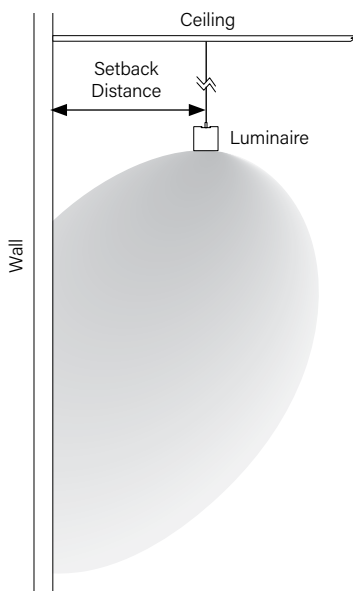

Submitted by:		Date:
Type:	Project:	
Ordering Info:		

0-10V Tunable White

Finelite's award-winning, contractor friendly Tunable White luminaires are available at low cost, with powerful and simple 0-10V tuning and intensity controls.

TUNABLE WHITE FEATURES

- CCT range: 2700K - 6500K
- Dimming Range: 100% to 10%
- CRI Options: 80 CRI or 90 CRI

PHOTOMETRY

Apply a power adjustment factor to calculate wattage usage

POWER	CONVERSION FACTOR
	1.1X

(Example: a 50 watt luminaire in static white would draw 55 watts using 0-10V Tunable White)

LUMINAIRE FAMILY MODIFICATIONS/RESTRICTIONS

Direct	Section Lengths											
	2'	3'	4'	5'	6'	7'	8'	9'	10'	11'	12'	
Output S,B,H,V Single Circuit	Rows can be comprised of 2'-12' sections. Tailored lengths available.											
Integral Battery Backup (BSL310LP)							✓		✓		✓	
Indirect/Direct												
Output S,B Single Circuit	✓	✓	✓	✓	✓	✓	✓	✓	✓	✓	✓	✓
Integral Battery Backup (BSL310LP)							✓		✓		✓	
Output H,V Single Circuit			✓				✓				✓	
Integral Battery Not Available	Remote Battery backup solution available. Consult factory for tailored lighting options.											
Output S,B,H,V Dual Circuit			✓				✓				✓	
Integral Battery Not Available	Remote Battery backup solution available. Consult factory for tailored lighting options.											

EN/GEN sections available for all body lengths

WIRING DIAGRAM - DIMMABLE TO 10%

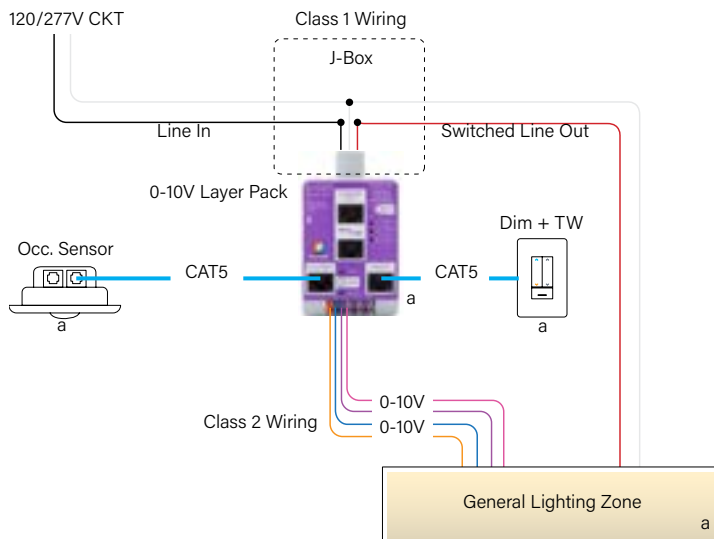

Luminaire Wiring

- **Purple (+) / Pink (-)** control wires are for intensity control
- **Orange (+) / Blue (-)** control wires are for Tunable White control

Note:

Load or Dim to Off options available.

DUAL FEED DETAIL

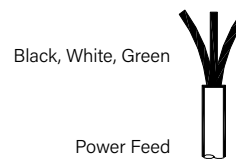

WIRING LEGEND		
Black	Hot	Line Voltage
White	Neutral	Line Voltage
Green	Ground	

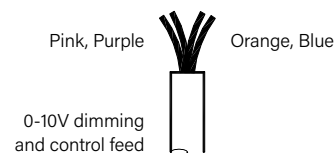

WIRING LEGEND		
Pink	Dimming	0-10V DC
Purple	Dimming	0-10V DC
Orange	TW	0-10V DC
Blue	TW	0-10V DC

