

FINELITE

Better Lighting

Series 11 LED

Micro Profile Cove

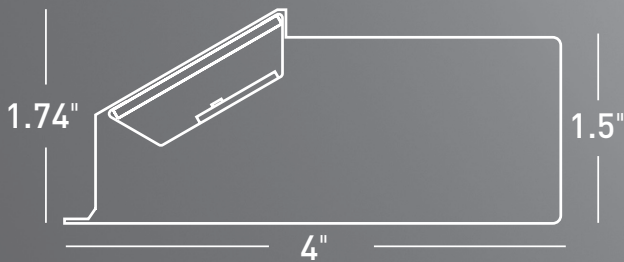

Flexible Cove Lighting

Series 11 LED Micro Profile Cove

Problem Solver

The **Series 11 LED Micro Profile** optional telescoping light engine provides up to 12 additional inches of luminaire to achieve a custom fit with uniform illumination.



Color Consistency



Multiple LED bins are custom blended to optimize color consistency and uniformity across the cove and across all Finelite LED luminaires.

Standard Lengths Ship in 10-days

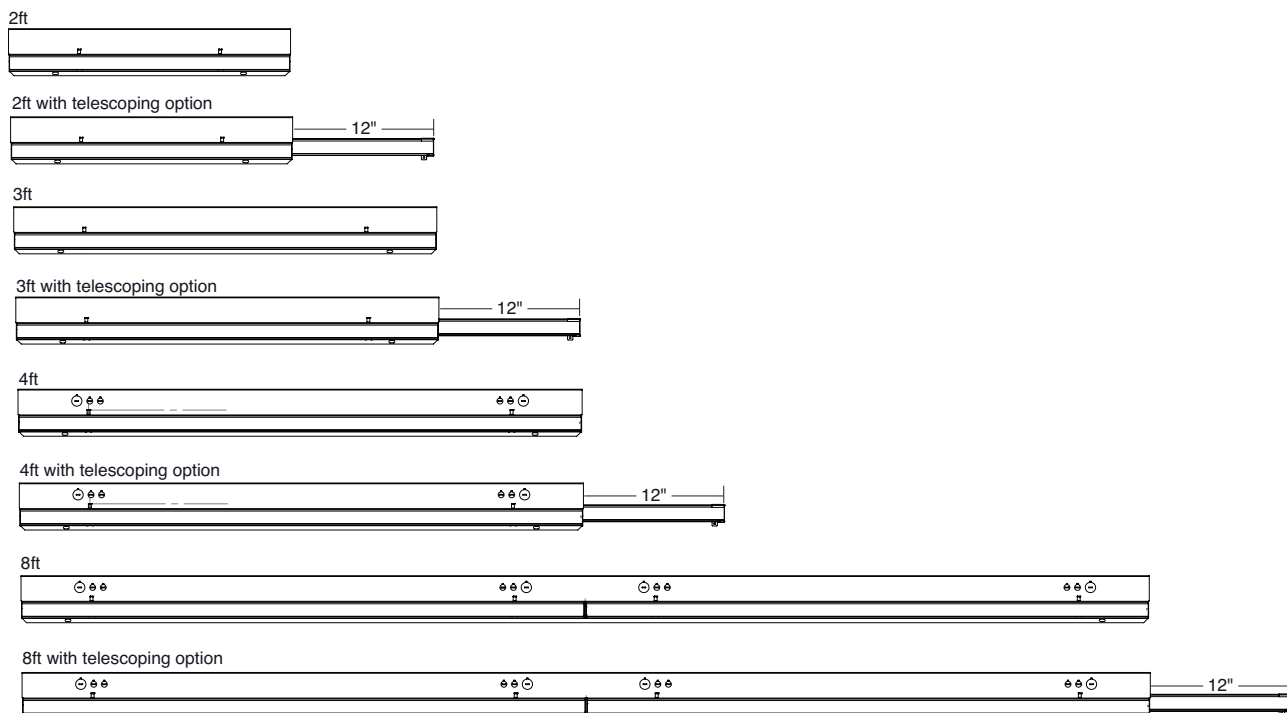

Performance

Series 11 LED Micro Profile Cove

High Output - per 4-foot section
 Efficacy: 92 lumens per watt
 Total Luminaire Output: 1797 lumens (449 lumens/foot)
 19.6 watts (4.9 watts/foot)

Peak Candela Value: 718 @ 145°
 CRI: 83
 R9: 20
 CCT: 3500K
 ITL LM79 Report 81639

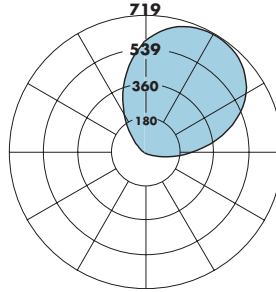
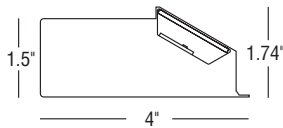

Candlepower Summary						
	0	45.0	90.0	135.0	180.0	Flux
90	245	155	0	0	0	0
95	314	208	15	0	0	105
105	453	319	74	0	0	163
115	571	431	154	2	0	216
125	652	526	245	40	9	256
135	700	597	339	120	49	275
145	718	640	429	219	140	268
155	713	658	504	332	261	227
165	684	649	555	445	397	154
175	623	613	581	542	523	55
180	584	584	584	584	584	

Fixture Placement

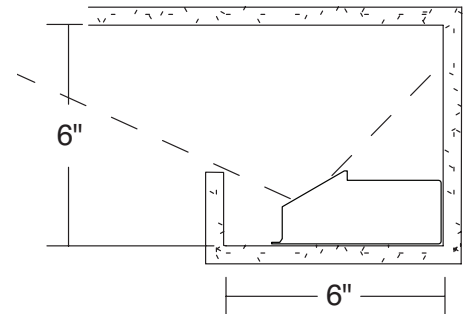
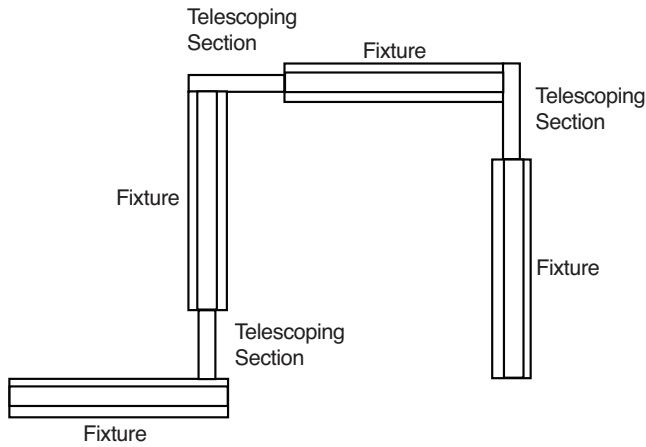

Designed to fit into an architectural cove with a suggested cross section of 6" x 6" or larger.

Application Data

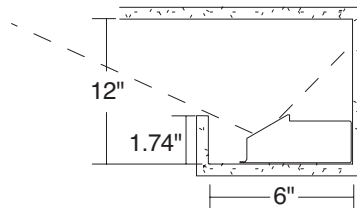

	HO 3500K per 4-Foot Section
Light Level (fc)	28
Avg to Min	1.8:1
Energy Consumption (LPD)	0.9 w/ft ²
Room Size	18' x 22'

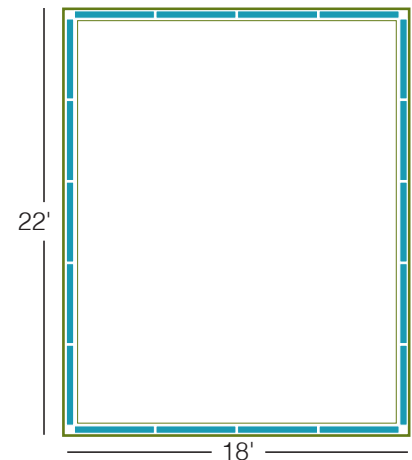

Initial light levels at work plane.

Ceiling Height: 10' / Cove Height: 1.74" / Cove Depth: 6" / Cove Reflectance: 80% / Room Reflectances: 80/50/20

Series 11 LED

FINELITE
Better Lighting

Ordering Guide

S11-LED-MP - 32' - SO - 3500K - SC - 96W - 277V - TXL

Finelite **Series 11-LED MICRO Profile** (MP) _____

Run Length (2', 3', 4', 8' Multiples Standard) _____

Light Engine (SO - Standard Output, HO - High Output) _____

LED Color Temperature (3000K, 3500K, 4000K) _____

Circuiting (SC - Single circuit, MC - Multi-circuit) _____

Reflector System (96W) _____

Voltage (120V, 277V) _____

Special Option (TXL - Telescoping Extra Length, 12" Max)* _____

* Leave blank if telescoping section is not required. The last segment in runs with "TXL" will include the adjustable section, unless otherwise specified.

The Finelite LED Difference



10-year warranty
on all components



90% of initial
light output for
100,000 hours



Dimming
standard

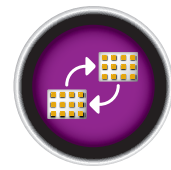

Replaceable
LED light array

Finelite Commitment To You



10-Day shipping on
standard orders for
all products



Focus on sustainability



Buy American Act of
2009 Compliant