

Submitted by:		Date:
Type:	Project:	
Ordering Info:		

E2 Indirect/Direct (E2-ID) Configuration

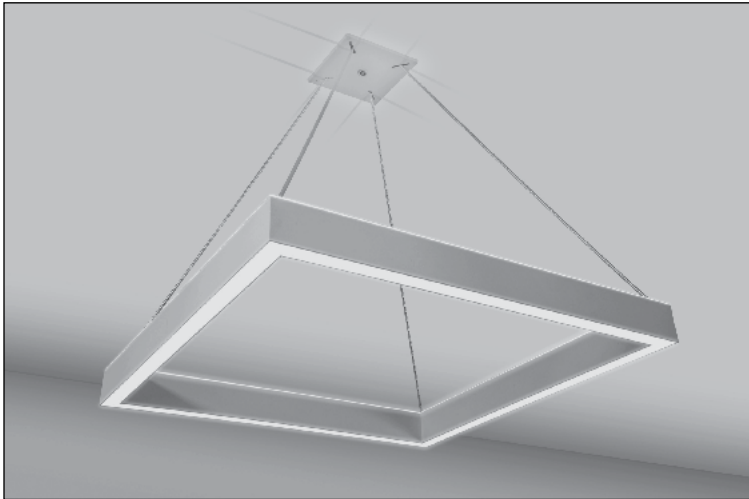

E2 Indirect/Direct (E2-ID) Configuration provides excellent light output with a minimalist shape. Based on the Elements platform, E2 uses easy-to-install power supply boxes and power suspension cables that enable independent control of uplight and downlight.

This product is enrolled in the International Living Future Institute (ILFI) Declare 2.0 Program and is third-party verified with options achieving **Red List Declared (RLD)** status.

Signal White is standard finish. Top Glow™ and OCC sensor show

CROSS SECTIONS

TOP GLOW DIFFUSER

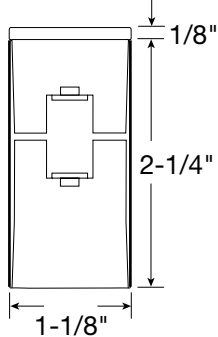

FLUSH DIFFUSER

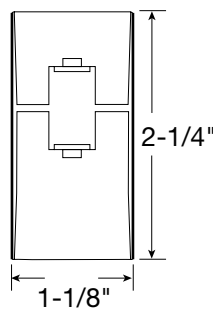

ELECTRICAL BOX OPTIONS



Low Profile T-Bar Power Supply Box (shown)

Various electrical boxes to meet application needs. Drivers easily accessible. See page 5 for more information.

STANDARD CONFIGURATIONS

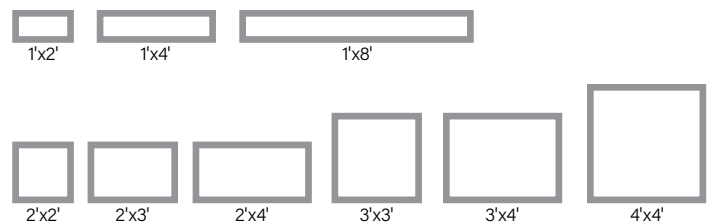

E2-ID configuration can be specified in various standard dimensions: 1'x2', 1'x4', 1'x8', 2'x2', 2'x3', 2'x4', 3'x3', 3'x4', and 4'x4'.



Declare.



Submitted by:		Date:
Type:	Project:	
Ordering Info:		

E2 Indirect/Direct (E2-ID) Configuration

BODY TYPE

Platform	Series Name	Luminaire Type	Luminaire Distribution	Standard Configurations		
E - Elements	2	P - Pendant	ID - Indirect/Direct	1' x 2' 1' x 4' 1' x 8'	2' x 2' 2' x 3' 2' x 4'	3' x 3' 3' x 4' 4' x 4'

OUTPUT and LED TYPE

MECHANICAL/OPTICAL OPTIONS

Uplight Output ID	Downlight Output	LED CRI/CCT	Uplight Option ID Only	Downlight Option	Reflector System
S - Standard (230 lm/ft)	S - Standard (147 lm/ft)	830 - 80 CRI min, 3000K	TG - Top Glow (Standard)	F - Flush (Standard)	96LG - 96 Low Gloss White
B - Boosted (290 lm/ft)	B - Boosted (185 lm/ft)	835 - 80 CRI min, 3500K	F - Flush Diffuser		
H - High (438 lm/ft)	H - High (280 lm/ft)	840 - 80 CRI min, 4000K			
V - Very High (563 lm/ft)	V - Very High (360 lm/ft)	930 - 90 CRI min, 3000K			
TL - Tailored: _____ lm/ft *	TL - Tailored: _____ lm/ft *	935 - 90 CRI min, 3500K 940 - 90 CRI min, 4000K			

* Specify lm/ft of outputs between Standard (S) and Very High (V). Consult factory for tailored lumen output outside of this range.

ELECTRICAL OPTIONS

MOUNTING OPTIONS

Voltage	Circuiting ¹	Driver Selection ²	Mounting Method
120 - 120 Voltage 277 - 277 Voltage 347 - 347 Voltage	SC - Single Circuit* One single circuit in a run DC - Dual Circuit* Independent control of up and down separately in an I/D style fixture *Battery, Night Light, and Emergency to Generator circuits are in addition to the normal luminaire circuit(s)	0-10V Driver Options FC-10% - 0-10V 10% (standard) ³ FC-1% - 0-10V 1% ³ DALI Driver Options FC-DALI-1% - DALI 1%	Lutron Driver Options LUT-ES1 - Lutron, Ecosystem 1% See Page 3 for additional driver options and details APC18 - Adjustable Power Cable 18" (Standard for 2x2 & 1x2) APC24 - Adjustable Power Cable 24" (Standard for all other sizes) See page 6 "Easy Installation" for details.

MOUNTING OPTIONS

POWER BOX OPTIONS

OTHER OPTIONS

Hardware	Power Box [*]	Finish	Emergency Style (Optional)
C1 - 15/16" T-Bar C2 - 9/16" T-Bar C3 - Screw Slot C4 - Hard Ceiling ⁴ OTS - Open to Structure	P01 - Low Profile with 6" Canopy P02 - Large Capacity with 6" Canopy P03 - Retrofit with 6" Canopy P01R - Remote Low Profile with 6" Canopy P02R - Remote Large Capacity with 6" Canopy P01R and P02R options include a Splice Box (S01) [*] See Page 5 for Electrical Box Option.	SW - Signal White (Standard) FB - Finelite Black SA - Satin Aluminum #### - RAL Color Code ⁵ _____	BSL722 - Bodine Battery Back-up ⁶

OTHER OPTIONS

Integrated Sensor (Optional)	Special Options (Optional)
OBO - Occupancy OBE - Enlighted ⁷ Sensor will be install on the canopy.	RLD - Red List Declared

¹ Contact factory for switching options

² For Indirect/Direct lengths 3' and greater, separate dimming for uplight and downlight available

³ Add DTO to gain "Dim to Off" functionality (FC-10% - DTO, FC-1% - DTO)

⁴ C4 is used for sheetrock ceilings. Contact Factory for open ceiling applications.

⁵ 20 Business day lead time for color

⁶ EM/GEN: must be full length of luminaire section. EM feed must be on the same luminaire section as the EM lighting.

⁷ Enlightened components installed by Finelite; Provided by OTHER

Submitted by:		Date:
Type:	Project:	
Ordering Info:		

E2 Indirect/Direct (E2-ID) Configuration

Specifications

BODY TYPE

CONSTRUCTION: Precision cut 6063-T6 extruded aluminum body. Top Glow™ diffuser snaps into place and is easily removed for service.

STANDARD CONFIGURATIONS: Available in 1'x2', 1'x4', 1'x8', 2'x2', 2'x3', 2'x4', 3'x3', 3'x4', and 4'x4' sizes. To find actual dimensions, add 1-1/8" to each section length.

ARRAY TYPE

LIGHT OUTPUT: Four lumen packages available, Standard (S), Boosted Standard (B), High (H), and Very High (V). A separate chart summarizes lumen distribution and wattage. For Tailored Outputs outside of range from Standard (S) to Very High (V), consult factory. Light engines are replaceable.

MECHANICAL FEATURES

UPLIGHT OPTION: The Top Glow diffuser is frost white standard. Coupled with light engine design, the diffuser spreads the light evenly for enhanced ceiling uniformity. Optional: Flush frost white snap-in diffuser.

DOWNLIGHT OPTION: Flush frost white snap-in diffuser standard. Coupled with light engine design, the diffuser spreads the light evenly for enhanced distribution.

LUMEN MAINTENANCE: 90% of initial light output (L90) at 100,000+ hours; 70% of initial light output (L70) at 200,000+ hours.

ELECTRICAL FEATURES

STATIC WHITE FEED: Standard suspension is conductive feed/suspension cable. 4-conductor cable standard delivering independent up light and downlight control. 5-conductor cables when using battery backup. Field adjustable length. Standard Suspension for 1'x2' and 2'x2' is 18" from the canopy to the top of the luminaire. Standard suspension for 1'x4', 1'x8', 2'x3', 2'x4', 3'x3', 3'x4', and 4'x4' is 24". Contact factory for additional lengths.

STATIC WHITE DRIVER: Replaceable 120V, 277V, and 347V Constant Current Reduction dimming driver standard. Can be wired dimming or non-dimming. 0-10V dimming controls with a range of 10% - 100%. Dimming to 1% available; Consult factory. Separate dimming for uplight and downlight available. Driver is fully accessible from below the ceiling.

- **Power Factor:** ≥ 0.9
- **Total Harmonic Distortion (THD):** <20%
- **Expected driver lifetime:** 100,000 hours

LUTRON STATIC DRIVER OPTIONS:

- **LUTES1 (LDE1)** - Hi-lume 1% EcoSystem with Soft-On, Fade-to-Black dimming (LDE1 series)

MOUNTING TYPE

HANGING HARDWARE: Standard E2-ID Configuration mounting is off-grid. Bar Hangers for mounting power supply boxes to joists are ordered separately. Consult Electrical Box Options (Page 4) for maintenance details.

OTHER FEATURES

EMERGENCY STYLE: Optional emergency to generator/inverter wiring, internal generator transfer switch, nightlight wiring, step-dimming driver, backup battery.

INTEGRATED SENSORS: Integrated Occupancy Sensors can be located in the canopy. Sensors are available when using the following power supply boxes: Low Profile T-Bar (P01), Large Capacity (P02), and Retrofit (P03) power supply boxes.

FINISHES: Finelite Signal White (SW) powder coat standard. Finelite Black (RAL 9005) with semi gloss fine texture (FB) and Satin Aluminum (SA) are available. Optional Adders: 179 RAL colors.¹

LABELS: Luminaire and electrical components are ETL-listed conforming to UL 1598 in the U.S.A. and CAN/CSA C22.2 No. 250.0 in Canada. In accordance with NEC Code 410.130 (G), this luminaire contains an internal driver disconnect. UL 924 and UL 2108 - PoE options available on request, contact factory for more details. These fixtures are rated for Damp Location. Chicago Plenum options available for C1, C2, or C3 suspension using our GridBox. Finelite products use electronic components that are RoHS compliant, and the mechanical components of the luminaire have been verified to not knowingly contain any restricted substances listed per RoHS Directive 2015/863. E2 can be used to comply with 2016 Title 24, Part 6 (JA8); high efficacy LED light source requirements. Finelite makes the specification process easy when putting healthier products on your projects. Simply add **RLD** (Red List Declared) to your part number.

WEIGHT: 1.0 lb per foot. 2'x2' weighs 8 lbs.

WARRANTY: 10-year performance-based warranty on all standard components. Optional accessories such as emergency battery packs are covered by their individual manufacturer warranties.

¹ 20 Business day lead time for color

Submitted by:		Date:
Type:	Project:	
Ordering Info:		

E2 Indirect/Direct (E2-ID) Configuration

ELECTRICAL BOX OPTIONS

E2 can be specified with power supply boxes to meet specific application needs. From new to retrofit, T-Bar to drywall, to fully remote, E2 power supply boxes install quickly and easily. Power supply boxes are IC Rated. Chicago Plenum available.

Code	Description	Canopy	#of Drivers Max	Ceiling Type	Driver Access	Battery Backup
P01	Low Profile T-bar Power Supply Box	6"	2	T-bar	Above Ceiling	No
P02	Large Capacity Power Supply Box	6"	4 or 2 w/battery	Drywall or T-bar	Below Ceiling	BSL722
P03	Retrofit Power Supply Box	6"	2	Drywall or T-bar	Below Ceiling	No
P01R	Remote Low Profile T-bar Power Supply Box	6"	2	T-bar	Above Ceiling	No
P02R	Remote Large Capacity Power Supply Box	6"	4 or 2 w/battery	Drywall or T-bar	Below Ceiling	BSL722
S01	Splice Box	6"	N/A	N/A	N/A	N/A
For Open Ceilings Use a Remote Power Supply Box Solution						
P01R	Remote Low Profile T-bar Power Supply Box	6"	2	Open Ceiling	Below Ceiling	No
P02R	Remote Large Capacity Power Supply Box	6"	4 or 2 w/battery	Open Ceiling	Below Ceiling	BSL722

Note:

- **P01R** and **P02R** options include a Splice Box (**S01**).

LOW PROFILE T-BAR POWER SUPPLY BOX (P01)

Dimensions: 10-1/8"W x 16-1/8"L x 1-11/16"D
Available: 1'x2', 1'x8'¹, 2'x2'



- T-Bar only
- Two drivers maximum per box
- Includes easy leveling system from below ceiling
- Access drivers from above ceiling for simple maintenance
- (7) 1/2" feed knockouts available to connect building power
- Optional Occupancy sensor located in canopy for a clean aesthetic

LARGE CAPACITY POWER SUPPLY BOX (P02)

Dimensions: 10"W x 23"L x 4"D
Available: 1'x2', 1'x4', 1'x8'¹, 2'x2', 2'x3', 2'x4', 3'x3', 3'x4', 4'x4'



- T-Bar or Drywall ceiling compatible ²
- Four drivers maximum per box or two drivers and one EM battery pack (illuminates 4' only) for egress
- Includes easy leveling system from below the ceiling
- Access to drivers from below ceiling to reduce maintenance time
- (4) 1/2" feed knockouts available to connect building power
- Optional Occupancy sensor located in canopy for a clean aesthetic

RETROFIT POWER SUPPLY BOX (P03)

Dimensions: 5"W x 14-3/8"L x 8-3/4"D
Available: 1'x2', 2'x2'



- T-Bar or Drywall ceiling compatible ²
- Two drivers maximum per box
- Includes easy leveling system from below ceiling
- Access to drivers from below ceiling to reduce maintenance time
- (4) 1/2" feed knockouts available to connect building power
- Optional Occupancy sensor located in canopy for a clean aesthetic

¹ 1'x8' is installed using two power supply boxes (one at each end of the luminaire).

² Contact Factory for open ceiling applications.

Submitted by:		Date:
Type:	Project:	
Ordering Info:		

E2 Indirect/Direct (E2-ID) Configuration

SPLICE BOX (S01)

Dimensions: 5"W x 5"L x 2-3/8"D



- T-Bar or Drywall ceiling compatible ¹
- Includes easy leveling system from below ceiling

Note: The Splice box is only used for remote power box applications.

EASY LEVELING SYSTEM ON ALL BOXES

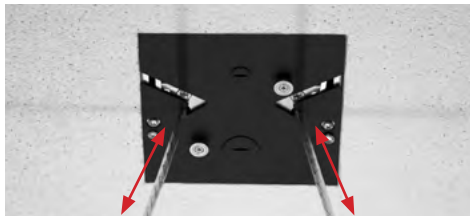
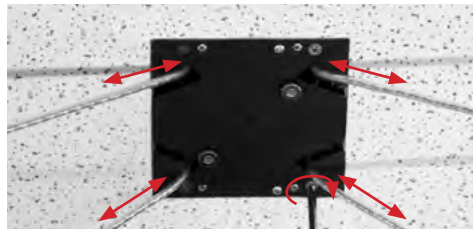

2 Leveling Screws (1x8 Only)

E2-ID Configuration includes a patent pending leveling system for simple individual suspension adjustment for a consistent luminaire sightline.

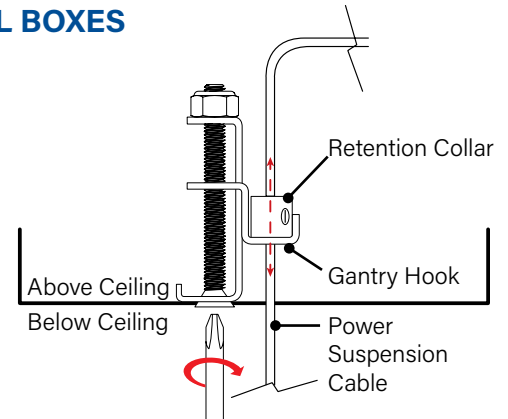

4 Leveling Screws

Scan this QR code with your mobile phone or tablet to watch video

LOW PROFILE T-BAR POWER SUPPLY BOXES (P01)

(T-Bar Ceiling)
(Max 2 Drivers)
1'x2', 1'x8' ², 2'x2'

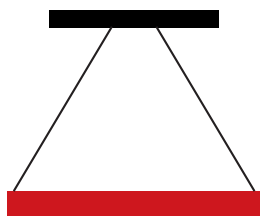

LARGE CAPACITY POWER SUPPLY BOXES (P02)

(Drywall or T-Bar Ceiling)
(Max 2 Drivers)
1'x2', 1'x4', 1'x8' ², 2'x2', 2'x3',
2'x4', 3'x3', 3'x4', 4'x4'

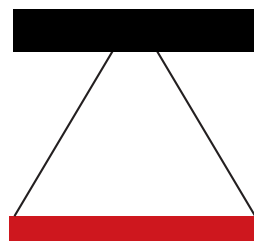

RETROFIT POWER SUPPLY BOXES (P03)

(Drywall or T-Bar Ceiling)
(Max 2 Drivers)
1'x2', 2'x2'

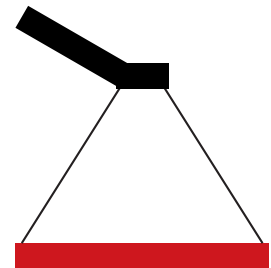

STANDARD CONFIGURATION DIMENSIONS (Drywall or T-Bar Ceiling)

To find actual dimensions for all configurations, add 1-1/8" to each section length.



1'x2'



1'x4'



1'x8'



2'x2'



2'x3'



2'x4'



3'x3'



3'x4'



4'x4'

¹ Contact Factory for open ceiling applications.

² 1'x8' is installed using two power supply boxes (one at each end of the luminaire).

Submitted by:		Date:
Type:	Project:	
Ordering Info:		

E2 Indirect/Direct (E2-ID) Configuration

EASY INSTALLATION

Specially designed mounting hardware and a unique canopy design makes E2 Configuration easy to install, level, and maintain. Designed to mount cleanly in the center of ceiling tile or sheetrock ceiling.

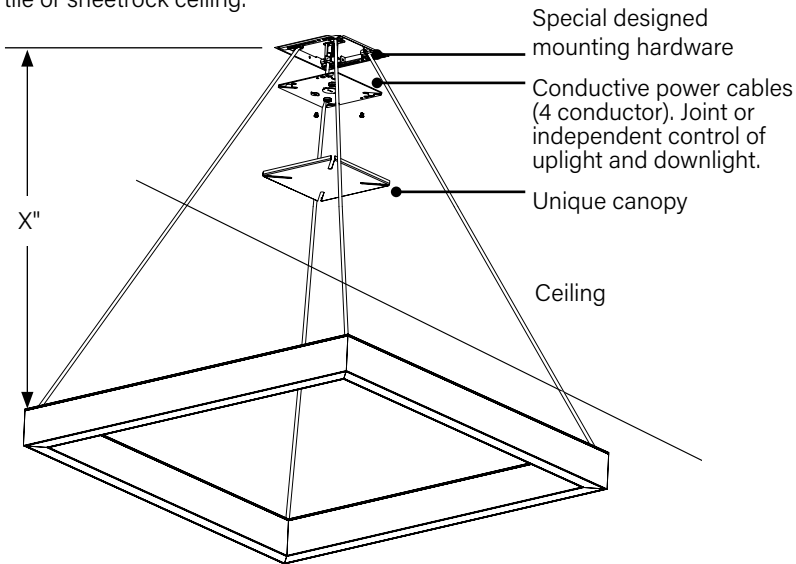

ROUGH-IN

T-Bar or Drywall

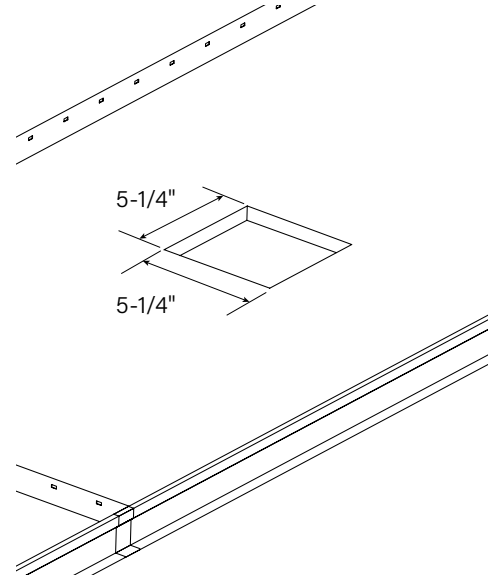

X" = Adjustable Power Cable length (18" or 24") from ceiling to luminaire.

ROUGH-IN THICKNESS

Collar must be flush with bottom of ceiling tile.

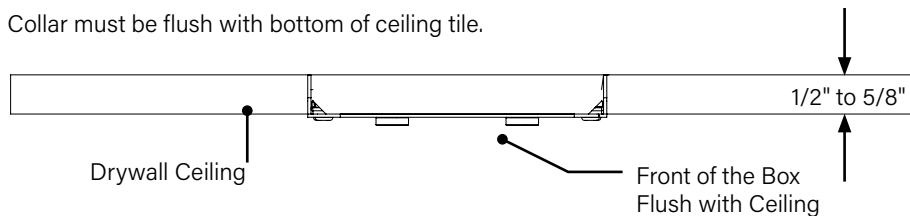

1'X8' INSTALLATION

The E2 1'x8' is installed using two power supply boxes (one at each end and directly above the luminaire).

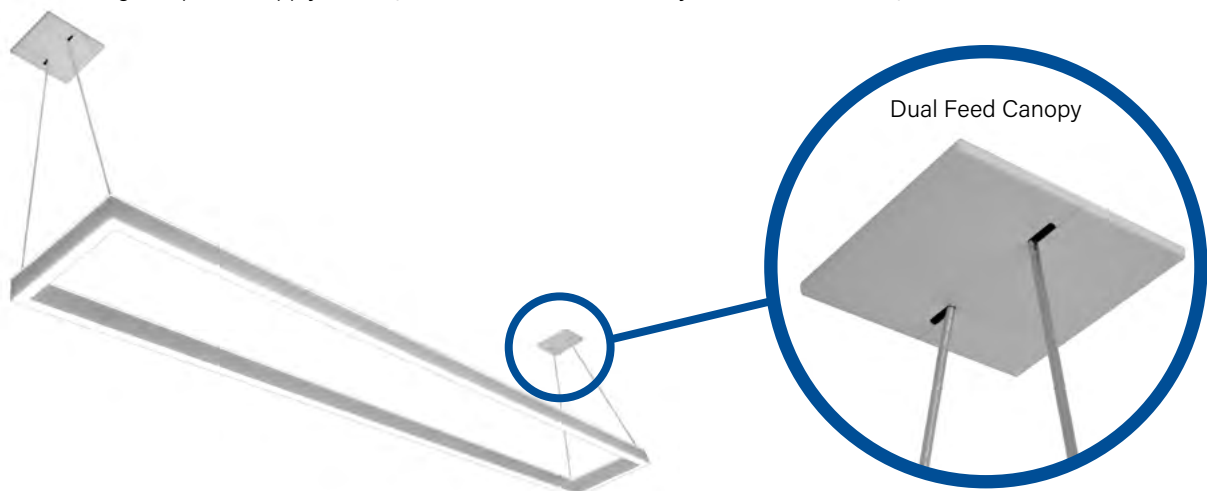

Submitted by:		Date:
Type:	Project:	
Ordering Info:		

E2 Indirect/Direct (E2-ID) Configuration

Indirect/Direct - 4' Luminaire 3500K

E2-ID-L-4'-V-V-835-F-F

Uplight: Flush / **Downlight:** Flush

Distribution: 61% Up (V) / 39% Down (V)

Efficacy: 99 lm/W

Uplight: 2250 lumens (563 lumens/ft)

Downlight: 1440 lumens (360 lumens/ft)

Total luminaire output: 3690 lumens (923 lumens/foot)
37.2 watts (9.3 watts/foot)

CRI: 80 / CCT: 3500K

ITL LM79 Report 89277

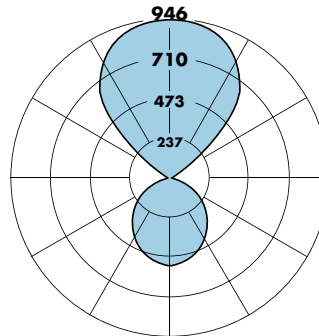

Total Light Output, 3500K, 80 CRI (Lumens Per Foot)

	↑S¹	↑B¹	↑H¹	↑V²
↓S¹	1511 [161% 39%↓]	1747 [166% 34%↓]	2339 [175% 25%↓]	2839 [179% 21%↓]
↓B¹	1662 [155% 45%↓]	1899 [161% 39%↓]	2491 [170% 30%↓]	2991 [175% 25%↓]
↓H¹	2041 [145% 55%↓]	2278 [151% 59%↓]	2870 [161% 39%↓]	3370 [167% 33%↓]
↓V¹	2361 [139% 61%↓]	2598 [145% 55%↓]	3190 [155% 45%↓]	3690 [161% 39%↓]

Light Output, 3500K, 80 CRI (Lumens Per Foot)

	↑S¹	↑B¹	↑H¹	↑V²
↓S¹	378	437	585	710
↓B¹	416	475	623	748
↓H¹	510	569	718	843
↓V¹	590	649	798	923

Power, 3500K, 80 CRI (Watts Per Foot)

	↑S¹	↑B¹	↑H¹	↑V²
↓S¹	3.8	4.3	5.5	6.6
↓B¹	4.3	4.8	6.0	7.0
↓H¹	5.5	6.0	7.2	8.3
↓V¹	6.6	7.0	8.3	9.3

Efficacy, 3500K, 80 CRI (Lumens Per Watt)

	↑S¹	↑B¹	↑H¹	↑V²
↓S¹	99	101	106	108
↓B¹	96	99	104	106
↓H¹	93	95	100	102
↓V¹	90	92	97	99

S - Standard Output, B - Boosted Standard Output, H - High Output, V - Very High Output

¹ Based on 4' luminaire 3500K Very High Output (V) test - 120V.

² Based on ITL report: 89277

Wattage is Real Power. If you would like additional details to calculate Apparent Power, please contact your local Finelite representative.

Sample Lumen Adjustment Calculation

Lumen Adjustment Factors 80 CRI		Lumen Adjustment Factors 90 CRI	
3000K	0.985	3000K	0.746
3500K	1.000	3500K	0.760
4000K	1.032	4000K	0.789

High Output (H) / Standard Output (S), 4000K, 90 CRI
Lumen Adjustment Factor: 0.789

Total Light Output: 2339 lm x 0.789 = 1846 lm

Total Light Output per Foot: 585 lm/ft x 0.789 = 462 lm/ft.
watts/foot: 5.5 W/ft.

$$\text{Efficacy} = \frac{462 \frac{\text{lm}}{\text{ft}}}{5.5 \frac{\text{W}}{\text{ft}}} = 84 \text{ lm/W}$$