



HP-4

High Performance 4" Aperture
CURVED

High Performance 4" Aperture (HP-4) CURVED

High Performance 4" Aperture Curved Sections are patented luminaires that add design flexibility to the HP-4 family. Curved Sections deliver continuous illumination and are available in 45°, 90°, and 180° angles with 2', 3', and 4' diameter options. All Curved Sections can be joined to HP-4 linear to create a multitude of configurations and are equipped with universal and robust joining hardware for strong and repeatable joints ensuring seamless transitions.

Features

Tailored Output

Optimizing lighting levels to accommodate architectural design elements and code requirements.

Static White Output Options:

- Standard (**S**)
- Boosted Standard (**B**)
- High (**H**)
- Very High (**V**)

0-10V Tunable White Output Options:

- Standard (**S**)
- Boosted Standard (**B**)
- High (**H**)
- Very High (**V**)

FineTune DMX Output Options:

- Boosted Standard (**B**)
- Very High (**V**)

Features

Tailored Color

Tune white light and intensity to the preferences of the people in the space.



- Static White light options at 3000K, 3500K and 4000K CCT
- Tunable White option for two-source tunable white light between 2700K and 6500K CCT
- 80+ and 90+ CRI options available

Features

Tailored Control

Dim and tune the lighting to fit user preference.

- Dimming from 100% to 10%, standard; 1% available
- Industry-leading pre-qualified drivers and controls options available
- Integrated or networked daylight and occupancy sensors options available
- Simplified white light color tuning design and installation with the FineTune™ controls system



Light Years Ahead

Finelite has formulated LED illumination that delivers 90% of initial light output (L90) at 100,000+ hours and 70% of initial light output (L70) at 183,000+ hours.

HP-4 Pendant & Recess Spackle Flange Are Available

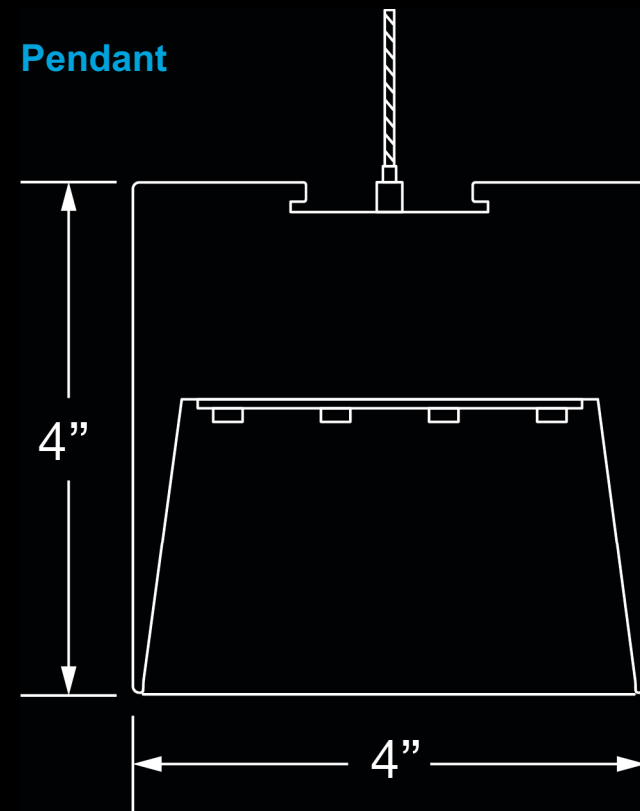

Recessed Spackle Flange

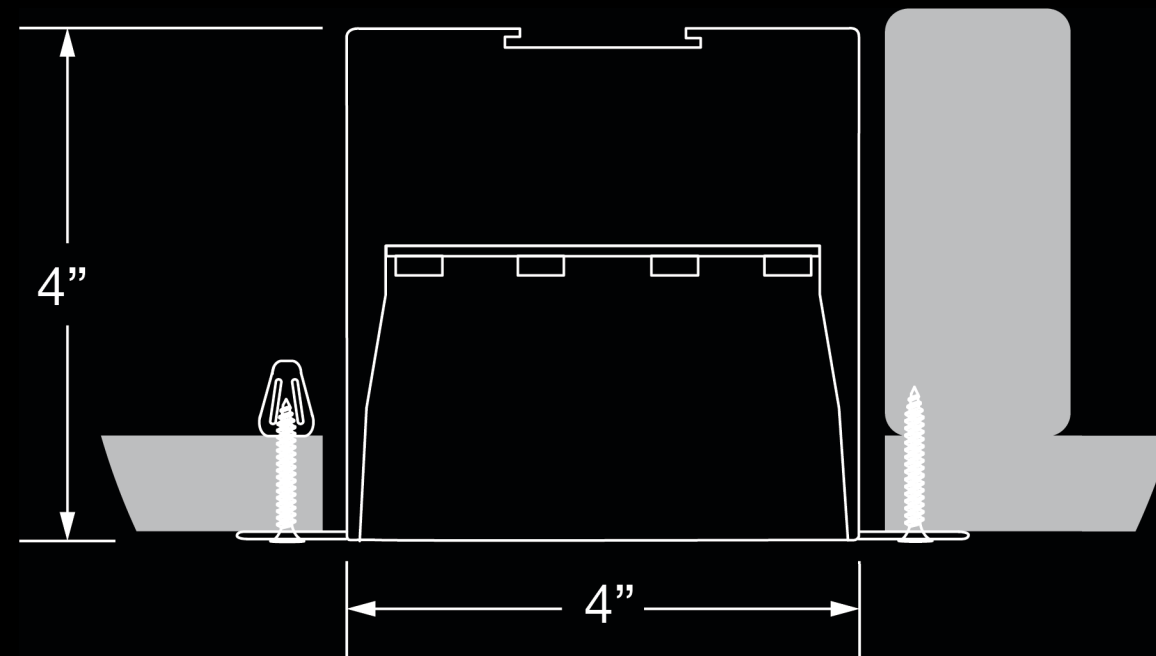

Diameters

Curved Sections deliver continuous illumination and are available in 45°, 90°, and 180° angles with 2', 3', and 4' diameter options.

2D

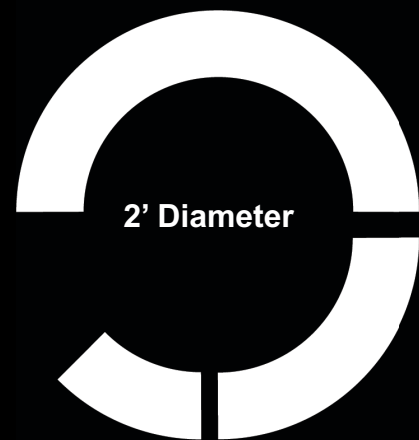

3D

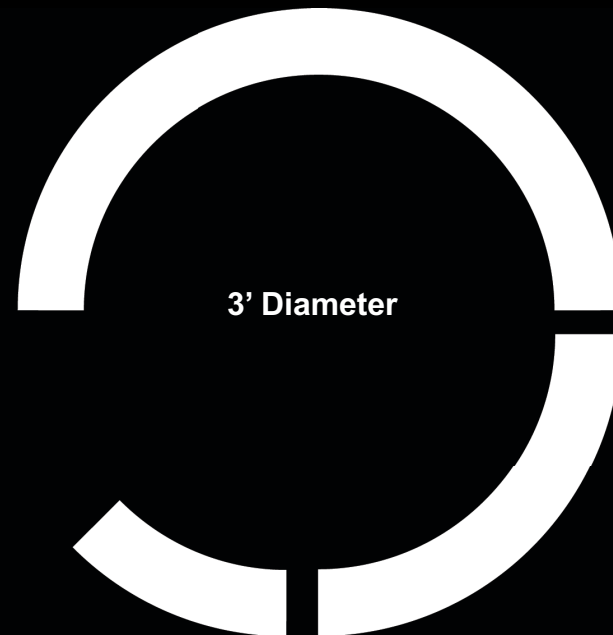

4D

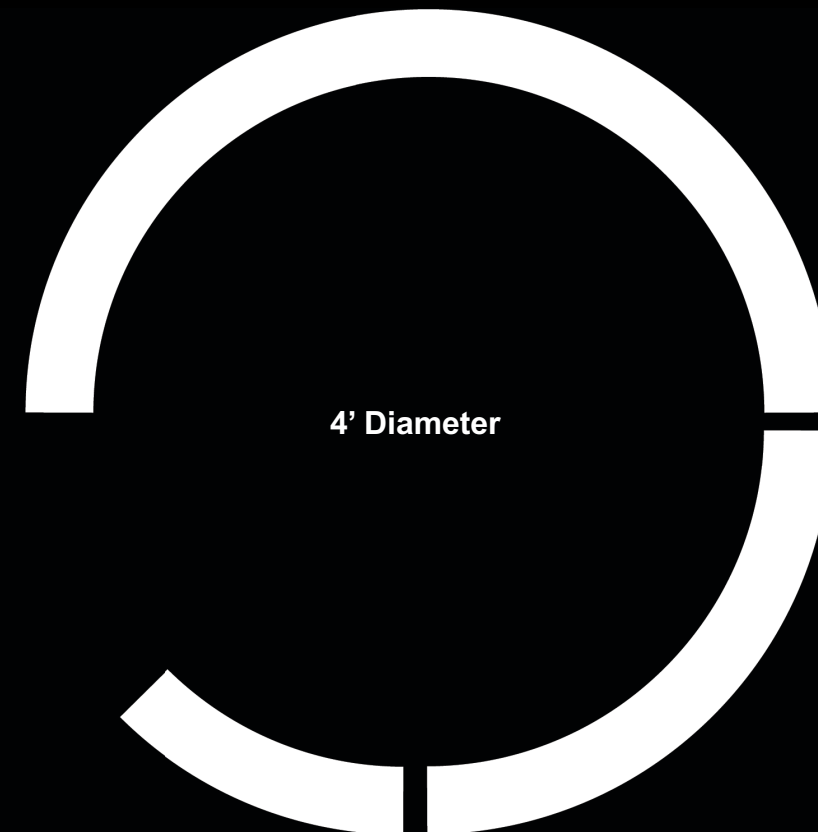

Diameters

Available in 45°, 90°, and 180°.

2D-45°



2D-90°



2D-180°



3D-45°



3D-90°



3D-180°

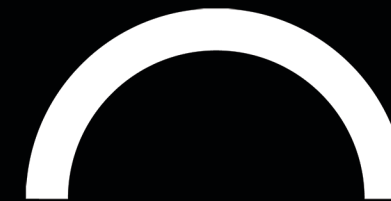

4D-45°



4D-90°



4D-180°

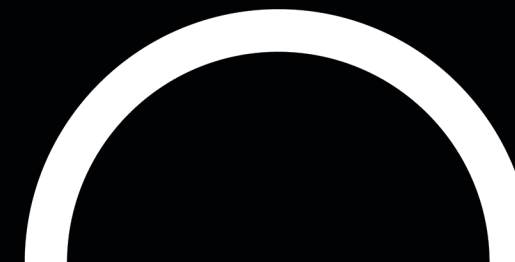

Standard Configurations

Round Square

RS ___x___

Rounded Square - Provide Side1 dimension and desired 90° curved section.

Example - RS6'x 2D90

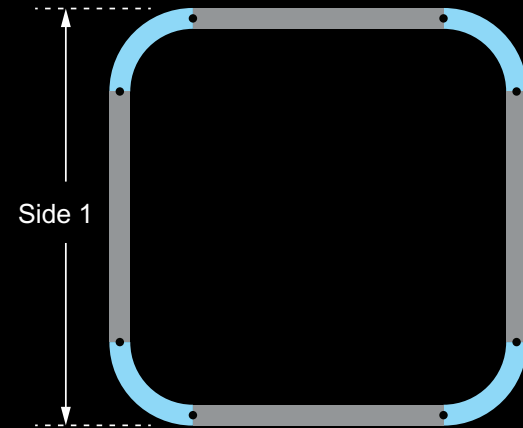

Round L

RL ___x___x___

Rounded L- Provide Side1x Side2 dimensions and desired 90° curved section.

Example - RL6'x 6'x 4D90

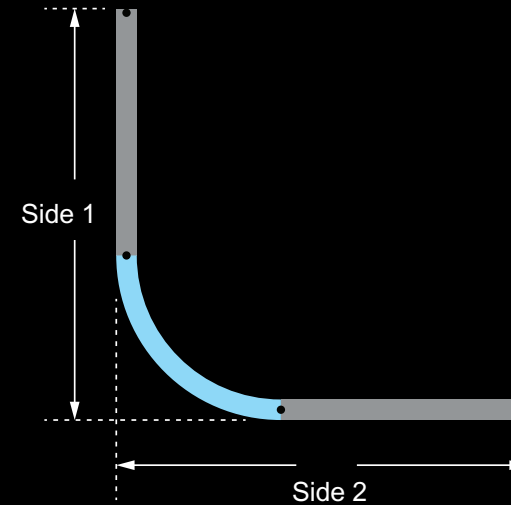

ARC

ARC ___

Arc - Provide desired curved section.

Example - ARC4D180

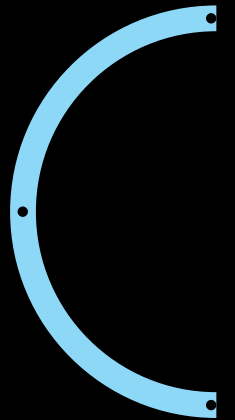

Round Rectangle

RR ___x___x___

Rounded Rectangle- Provide Side1 x Side2 dimension and desired 90° curved section.

Example - RR5'x 7'x 3D90

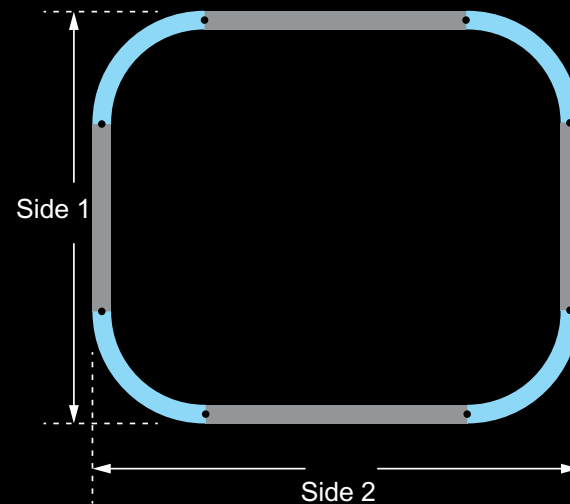

Round U

RU ___x___x___x___

Rounded U - Provide Side1x Side2 x Side3 dimensions and desired 90° or 180° curved section.

Example - RU8'x6'x4'x2D90

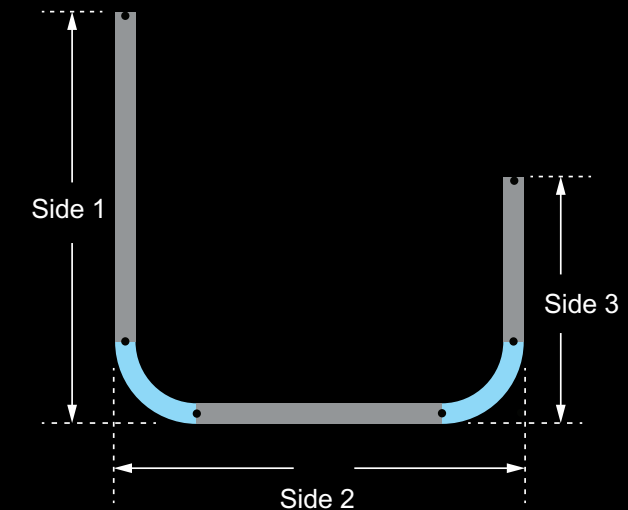

Custom Configurations Available

99CFG

Custom Configuration -
Please provide a
sketch or drawing
showing desired linear
length dimensions and
curved sections.

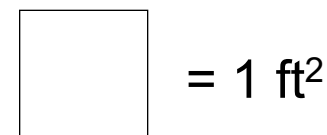
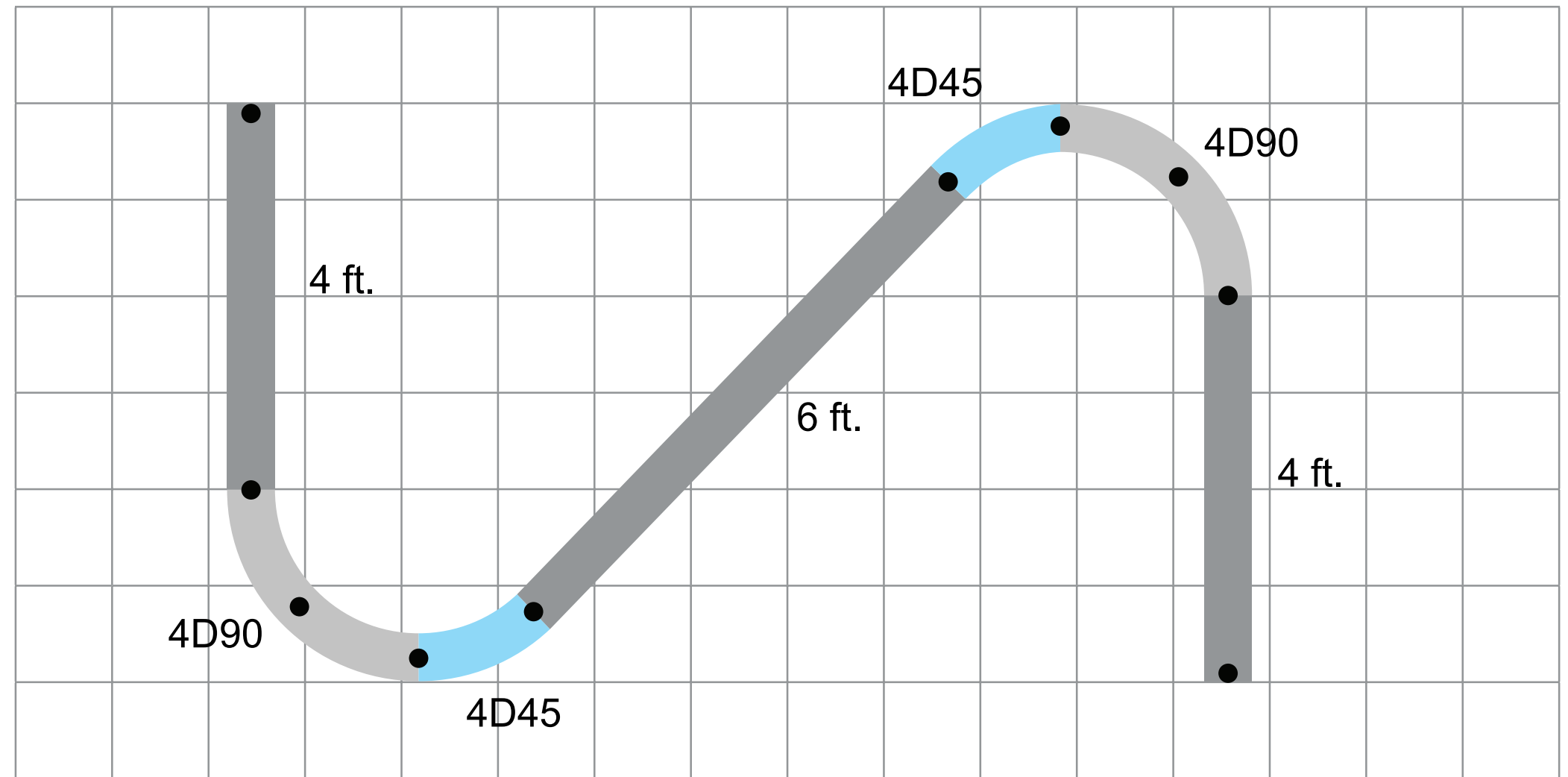

Tailored Control System Compatible



Control Station



Low Voltage Switches

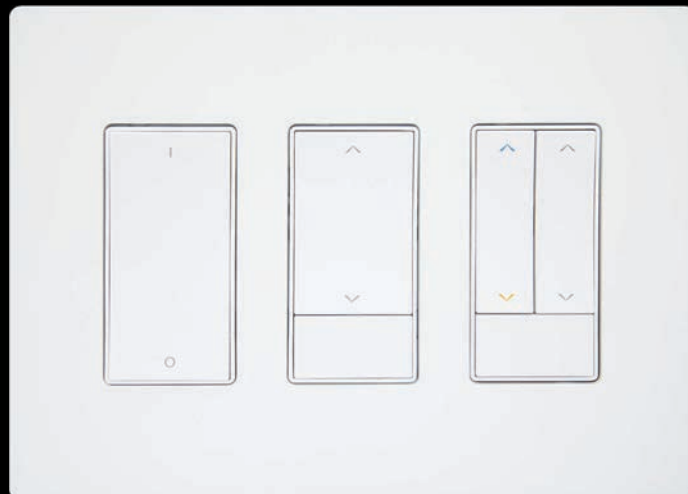

Layer Packs



Sensors



LED Luminaires



The Finelite LED Difference



10-year performance-based warranty



90% of initial light output at 100,000+ hours



Dimming Standard



Replaceable LED light arrays