

Submitted by:		Date:
Type:	Project:	
Ordering Info:		

High Performance 4" Aperture (HP-4) Wall Mount and Arm Mount

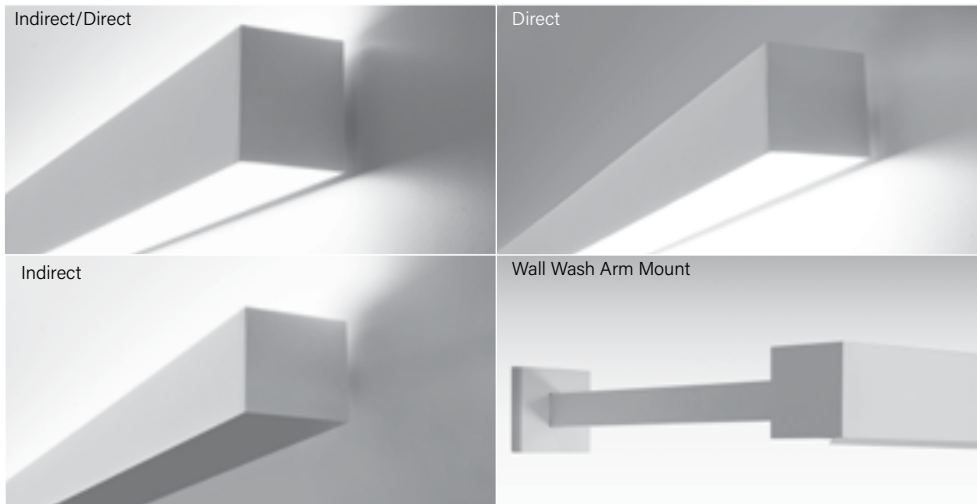

High Performance 4" Aperture Wall Mount family includes Indirect/Direct, Direct, Indirect, and Wall Wash Arm Mount luminaires. HP-4 delivers excellent performance using an advanced optical design and mid-power LEDs to achieve 90% of initial light output at 100,000+ hours.

This product is enrolled in the International Living Future Institute (ILFI) Declare 2.0 Program and is third-party verified with options achieving **Red List Approved** and **Red List Declared** status.

Signal White is standard finish

Note: see page 6 for all aesthetic options

CROSS SECTIONS

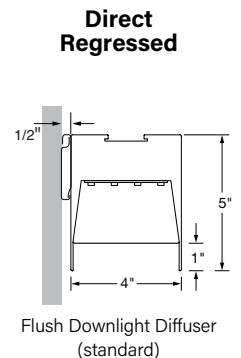
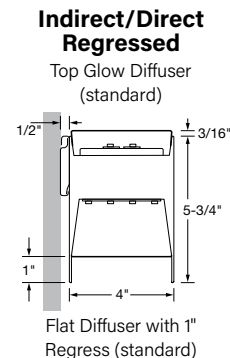
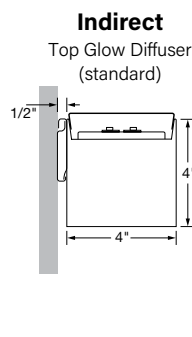
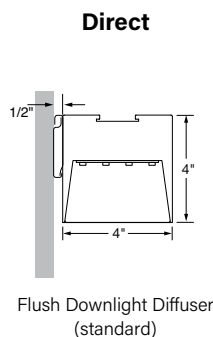
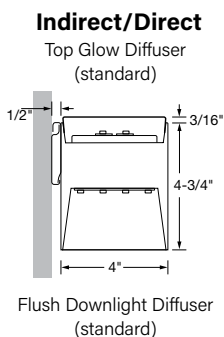

Wall Wash Arm Mount

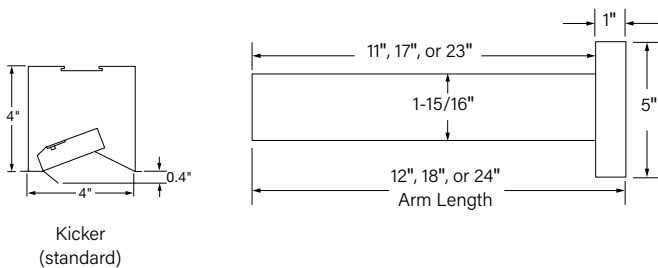

ALSO AVAILABLE IN

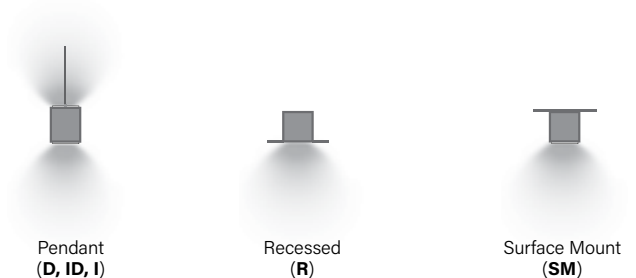

Declare.



Submitted by:		Date:
Type:	Project:	
Ordering Info:		

High Performance 4" Aperture (HP-4) Wall Mount and Arm Mount

Ordering Guide Example: HP - 4 - WM - ID - 36' - S - S - 835 - F - F - 96LG - 120 - SC - FC-10% - MB - FE - SW - LGD18W - OBO - CP

BODY TYPE

OUTPUT and LED TYPE

Platform	Series Name	Luminaire Type	Luminaire Distribution	Total Length of Run	Uplight Output ID & I Only (Flush)	Downlight Output ID & D Only (Flush)
HP - High Performance	4	WM - Wall Mount ¹ WM RG - Wall Mount Regressed ¹ AM - Arm Mount AM RG - Arm Mount Regressed	Wall Mount D - Direct ID - Indirect/Direct I - Indirect Arm Mount D - Direct ID - Indirect/Direct I - Indirect (Not available for AM RG) WW-D - Wall Wash Direct (Not available for AM RG)	Minimum 2' section length. Increments accurate to 1/16" (±1/32"), standard. 12' maximum section length.	S - Standard (428 lm/ft) B - Boosted (538 lm/ft) H - High (813 lm/ft) V - Very High (1045 lm/ft) TL - Tailored: _____ lm/ft*	S - Standard (379 lm/ft) B - Boosted (477 lm/ft) H - High (721 lm/ft) V - Very High (927 lm/ft) TL - Tailored: _____ lm/ft*

Lumen provided above are for Flush lens only, see pg. 15 for WW lumens.
* Specify Tailored lm/ft of outputs between Standard (S) and Very High (V). Consult factory for tailored lumen output outside of this range.

MECHANICAL/OPTICAL OPTIONS

ELECTRICAL OPTIONS

LED CRI/CCT	Uplight Optics ID & I Only	Downlight Optics ID & D Only	Reflector System	Voltage
830 - 80 CRI, 3000K	TG - Top Glow (standard)	F - Flush (standard) ¹	96LG - 96 Low Gloss White	120 - 120 Voltage
835 - 80 CRI, 3500K	F - Flush	BG - Bottom Glow ¹	SSA - Semi-Specular	277 - 277 Voltage
840 - 80 CRI, 4000K	ASY-L - Asymmetric Left Optic	DAO-L - Downlight Asymmetric Optic Left ¹	Aluminum for Wall Wash only	347 - 347 Voltage
930 - 90 CRI, 3000K	ASY-R - Asymmetric Right Optic	DAO-R - Downlight Asymmetric Optic Right ¹		
935 - 90 CRI, 3500K	ASYTG-L - Asymmetric Left Optic with Top Glow	DL - 1" Drop Down Lens ¹		
940 - 90 CRI, 4000K	ASYTG-R - Asymmetric Right Optic with Top Glow	RG-D - Flat Diffuser with 1" Regress ^{1,2}		
8TW - 80 CRI, Tunable White	WSO - Widespread Optic	RG-WCB - White Cross Blade Baffle ^{1,2}		
9TW - 90 CRI, Tunable White	WSOTG - Widespread Optic with Top Glow	RG-LHE - Hollowed Ellipse Louver ^{1,2}		
		RG-LHC - Hex Louver ^{1,2}		
		K - Kicker for Wall Wash only (standard) ³		
		FO - Fully Open for Wall Wash only		

ELECTRICAL OPTIONS

MOUNTING OPTIONS

Circuiting ⁴	Driver Selection	Mounting Method
SC - Single Circuit* One single circuit in a run DC - Dual Circuit* ⁵ Independent control of up and down separately in an I/D style fixture MC - Multi-Circuit* More than one switch leg or zone. Factory shop drawings required * Battery, Night Light, and Emergency to Generator circuits are in addition to the normal luminaire circuit(s)	0-10V Driver Options FC-10% - 0-10V 10% (standard) FC-1% - 0-10V 1% OTI-10% - EldoLED OTi, 0-10V 10% ⁶ OTI-1% - EldoLED OTi, 0-10V 1% ⁶ ELD-10V-0% - EldoLED SOLoDrive, 0-10V 0.1% 10V-TW-10% - EldoLED OTi, 0-10V 10% (Tunable White) ⁶ DALI Driver Options FC-DALI-1% - DALI 1% DXL-DALI-1% - EldoLED Dexal, 1% ELD-DALI-0% - EldoLED SOLoDrive, 0.1% ELD-DALI-TW - EldoLED DUALdrive LightShape, 0.1% (Tunable White)	MB - Mounting Bracket Wall Mount only AM12 - 12" Arm Mount only AM18 - 18" Arm Mount only AM24 - 24" Arm Mount only See Page 3 for additional driver options and details

OTHER OPTIONS

Endcap Style	Emergency Style (Optional) <small>See page 5 Backup Battery table</small>	Integrated Sensor (Optional) ⁹	Special Options (Optional)
FE - Flat Endcap (standard)	LGD18W - Legrand 18W Brand Battery Back-up	OBO - Occupancy	AOCC-W - Lutron Athena Sensor ¹⁴ (Device Color White)
DE - 1" Drop Endcap ⁸	LGD10W - Legrand 10W Brand Battery Back-up	OBD - Daylight	AOCC-B - Lutron Athena Sensor ¹⁴ (Device Color Black)
OE - Open Endcap ⁹	EM/GEN - Emergency to Generator	W601 - Wattstopper Sensor ¹¹	ARF-W - Lutron Athena RF ¹⁴ (Device Color White)
Finish	NL - Night Light	OBE - Enlighthed Sensor ¹²	ARF-B - Lutron Athena RF ¹⁴ (Device Color Black)
SW - Signal White (standard)	BSL722 - Bodine Battery Back up	REE - Remote Enlighthed ¹³	VOCC - Lutron Vive Sensor ¹⁵
FB - Finelite Black	BSL310LP - Bodine Battery Back up Low Profile	CLM-99 - Encelium RF	VRF - Lutron Vive RF ¹⁵
SA - Satin Aluminum	GTD - Generator Transfer Device	SLM-99 - Encelium Sensor	
#### - RAL Color Code ¹⁰	ALCR - Automatic Load Control Relay		

¹ Not available for Wall Wash

² Regressed only

³ Kicker standard in Signal White. Customer Custom color kickers have a surcharge

⁴ Contact factory for switching options

⁵ Indirect/Direct only

⁶ Add DTO to gain "Dim to Off" functionality (FC-10% - DTO, FC-1% - DTO)

⁷ B & V outputs only

⁸ 1" Drop Down Lens downlight only

⁹ Available with Hollowed Ellipse Louver (LHE) only

¹⁰ 20 business days lead time for color

¹¹ LMFS-601 w/ 0-10V driver(s) and LMFI-111, up to 6 drivers may be connected.

¹² LMFS-601 w/ Dali driver, only 1 driver can be connected.

¹³ Enlighthed components installed by Finelite, provided by others

¹⁴ Enlighthed for Wall Wash fixtures. Enlighthed Control Unit & Sensor Cable installed for

Remote mounting sensor

¹⁴ 0-10V Drivers - **AOCC** up to 10 drivers may be connected; **ARF** up to 40 driver may be connected DALI Drivers - **AOCC** & **ARF** up to 4 drivers can be connected

¹⁵ Lutron Vive Integrated Sensors require a DALI driver. Contact Factory for indirect Distribution.

Submitted by:		Date:
Type:	Project:	
Ordering Info:		

High Performance 4" Aperture (HP-4) Wall Mount and Arm Mount

SUPPLEMENTARY DRIVER PAGE

0-10V Driver Options

FC-10%	Factory Choice, 0-10V 10% Dimming (Linear)
FC-10%-DTO	Factory Choice, 0-10V 10% Dimming, Dim-to-Off (Linear)
FC-1%	Factory Choice, 0-10V 1% Dimming (Linear)
FC-1%-DTO	Factory Choice, 0-10V 1% Dimming, Dim-to-Off (Linear)
ELD-10V-0%	EldoLED SOLOdrive, 0-10V 0.1% Dimming (Linear)
ELD-10V-1%	EldoLED ECOdrive, 0-10V 1% Dimming (Linear)
10V-TW-10%	EldoLED OTi, 0-10V 10% Dimming, Tunable White (Linear)
10V-TW-10%-DTO	EldoLED OTi, 0-10V 10% Dimming, Dim-to-Off, Tunable White (Linear)
OTi-10%	EldoLED OTi, 0-10V 10% Dimming (Linear)
OTi-10%-DTO	EldoLED OTi, 0-10V 10% Dimming, Dim-to-Off (Linear)
OTi-1%	EldoLED OTi, 0-10V 1% Dimming (Linear)
OTi-1%-DTO	EldoLED OTi, 0-10V 1% Dimming, Dim-to-Off (Linear)

DALI Driver Options

FC-DALI-1%	Factory Choice, DALI 1% Dimming (Logarithmic)
DXL-DALI-1%	EldoLED Dexal, DALI 1% Dimming (Logarithmic)
ELD-DALI-0%	EldoLED SOLOdrive, DALI 0.1% Dimming (Logarithmic)
ELD-DALI-1%	EldoLED ECOdrive, DALI 1% Dimming (Logarithmic)
ELD-DALI-TW	EldoLED DUALdrive Light Shape, DALI 0.1% Dimming, Tunable White (Logarithmic Dimming, Linear CCT Control)

Lutron Driver Options

LUT-ES1	Lutron, Ecosystem 1% Dimming
LUT-TW	Lutron T-Series, EcoSystem 0.1% Dimming, Tunable White

Submitted by:		Date:
Type:	Project:	
Ordering Info:		

High Performance 4" Aperture (HP-4) Wall Mount and Arm Mount

SPECIFICATIONS

BODY TYPE

CONSTRUCTION: Precision-cut 6063-T6 extruded aluminum body. Internal joiner system, plug-together wiring, standard.

LENGTHS: Any length, 2' minimum, in increments down to 1/16" ($\pm 1/32"$). 12' maximum section length. Hollowed Ellipse Louver (**LHE**), Hex Louver (**LHC**), and White Cross Blade Baffle (**WCB**) are available in 1' increments.

MITERED CORNERS¹: Illuminated corners of greater than 60° and less than 180° in a single plane, available with Flush Diffuser, Bottom Glow Diffuser, Regressed Diffuser, White Cross Blade Baffle² or Wall Wash. Corners not available with Wall Wash (**WW-D**), Hollowed Ellipse Louver (**LHE**), Hex Louver (**LHC**) or 1" Drop Down Lens. Contact factory for Double miters using the White Cross Blade Baffle. Consult factory for tailored lighting options.

OUTPUT AND LED TYPE

LIGHT OUTPUT: Four lumen packages available, Standard (**S**), Boosted Standard (**B**), High (**H**), and Very High (**V**). For lengths 3' and greater, the uplight and downlight can be specified with different lumen packages and dual controls. For Tailored Outputs outside of range from Standard (**S**) to Very High (**V**), consult factory. Light engines are replaceable.

MECHANICAL/OPTICAL OPTIONS

UPLIGHT OPTION⁴: Patented Top Glow frost white diffuser standard. 12 ft. maximum diffuser length. 73% transmissive, 99% diffusion. Internal secondary diffusers at corners ensure visually seamless, uniform, continuous illumination. Optional: Flush frost white snap-in diffuser, 73% transmissive, 99% diffusion; Widespread Optic (**WSO**) and Widespread Optic with Top Glow (**WSOTG**); WSO enables increased luminaire spacing with improved ceiling uniformity. **ASY-L** distributes light to the left, **ASY-R** distributed light to the right of the luminaire. Consult factory for more tailored lumen outputs.

DOWNLIGHT OPTION⁵: 12' maximum diffuser length. Flush frost white snap-in diffuser standard, 73% transmissive, 99% diffusion. Internal secondary diffusers at corners ensure visually seamless, uniform, continuous illumination. Available with Flush (**F**), Bottom Glow (**BG**), 1" Drop Down Lens (**DL**), White Cross Blade Baffle (**WCB**)⁶, Hollowed Ellipse Louver (**LHE**)⁶, Hex Louver (**LHC**)⁶, Downlight Asymmetric Optic Left and Right (**DAO-L**, **DAO-R**)¹, and Regressed downlight diffusers (**RG**). 1" Drop Down Lens made of highly efficient acrylic. Available with a solid endcap or an endcap with a diffuse filler to continue the luminous aesthetic. Downlight Asymmetric Optic (**DAO**) are an extruded lenses with a subtle ribbed appearance providing desired improved optical performance. Consult factory for more tailored lumen outputs.

LUMEN MAINTENANCE: 90% of initial light output (L90) at 100,000+ hours; 70% of initial light output (L70) at 200,000+ hours.

REFLECTORS: Wall Mount: Die-formed 20-gauge cold-rolled steel reflectors finished in 96LG High Reflectance white powder coat paint. **Arm Mount:** The standard Semi-Specular Aluminum (**SSA**) Kicker (**K**) reflector delivers light high on the vertical surface. The Kicker reflector can be easily removed for open distribution (**FO**).

ELECTRICAL FEATURES

STATIC WHITE FEED: Standard with one 18-gauge/5-conductor single-circuit feed controlling uplight and downlight together (power and dimming). Specify dual feeds for independent control of uplight and downlight. 14-gauge feed used when luminaire current exceeds 5 amps.

TUNABLE WHITE FEED: Standard with one 18-gauge/5-conductor single-circuit feed. 14-gauge feed used when luminaire current exceeds 5 amps.

STATIC WHITE DRIVER: Replaceable 120V, 277V, and 347V Constant Current Reduction dimming driver standard. Can be wired dimming or non-dimming. 0-10V dimming controls with a range of 10%- 100% standard. Dimming to 1% available. Separate dimming for uplight and downlight available. Driver is fully accessible from below the ceiling.

- **Power Factor:** ≥ 0.9
- **Total Harmonic Distortion (THD):** <20%
- **Expected driver lifetime:** 100,000 hours

LUTRON DRIVER OPTIONS:

- **LUT-ES1 (LDE1)** - Hi-lume 1% EcoSystem with Soft-On, Fade-to-Black dimming (LDE1 series).

TUNABLE WHITE DRIVER: Replaceable LED driver. Driver is accessible from below the ceiling. 120V, 277V, and 347V.

- **Power factor:** ≥ 0.90
- **Total Harmonic Distortion (THD):** <20%
- **Dimming Range:** 100%-10%
- **Expected driver lifetime:** 100,000 hours

LUTRON TUNABLE WHITE DRIVER OPTION: LUT-TW (1% T-Series 2-Channel Digital Tunable White (PSQ Series)).

MOUNTING OPTIONS

HANGING HARDWARE: Wall Mount: Luminaire hangs securely from mounting brackets fastened directly to the wall for easy installation. Luminaire stands 1/2" off the wall. The mounting bracket is concealed behind the luminaire. **Arm Mount:** bracket mounts directly to wall j-box, extends luminaire 12", 18", or 24" from wall. Other lengths available. Consult factory.

TUNABLE WHITE HANGING HARDWARE: For grid ceiling applications the dual GridBox™ mounting is supplied (standard). For hard ceiling applications the ceiling mounting box is supplied (standard).

TUNABLE WHITE INTERCONNECTION CABLES: Luminaires are pre-wired with plug-and-play interconnection cables to support easy plug-together joining of luminaire runs.

¹ Not available with Wall Wash

² Indirect/Direct and Direct only

³ White Cross Blade (WCB) baffles not available with custom angles. Available in 90 degrees only

⁴ Wall Mount Indirect/Direct, Wall Mount Regressed Indirect/Direct, and Wall Mount Indirect only

⁵ Wall Mount Indirect/Direct, Wall Mount Regressed Indirect/Direct, Wall Mount Direct, and Wall Mount Regressed Direct only

⁶ Wall Mount Regressed Indirect/Direct & Wall Mount Regressed Direct only

Submitted by:		Date:
Type:	Project:	
Ordering Info:		

High Performance 4" Aperture (HP-4) Wall Mount and Arm Mount

SPECIFICATIONS

OTHER OPTIONS

ENDCAPS: Flat diecast aluminum endcaps (**FE**) add 1/4" to each end of luminaire. 1" Drop Down Lens Endcap (**DE**)⁷ includes diffuse element to continue luminance of drop lens. Open Endcap (**OE**) is for use with the Hollowed Ellipse Louver (**LHE**); following the curve of the louver.

EMERGENCY STYLE: Optional emergency to generator/inverter wiring, internal generator transfer switch, nightlight wiring, step-dimming driver, backup battery.

Backup Battery		
	Legrand 18W	Legrand 10W/ Bodine BSL310LP
HP4-P-D		
Min. Housing Length	8'	4'
EM Lumen Output	1854	1102
EM Section Illum.	2'	2' or 4'
HP4-P-WW-D		
Min. Housing Length	8'*	4'*
EM Lumen Output	2000	1189
EM Section Illum.	4'	4'
HP4-P-ID		
Min. Housing Length	8'	4'
EM Lumen Output	1854	1102
EM Section Illum.	2'	2' or 4'
HP4-P-I		
Min. Housing Length	8'	4'
EM Lumen Output	2057	1222
EM Section Illum.	2'	2' or 4'

* Minimum fixture housing length for battery pack approved without sensor
The lumens are based on 835. For other CCT/CRI, refer to the Lumen Adjustment Factor table on page 9.

TUNABLE WHITE ELECTRICAL OPTIONS⁸:

- **TW Driver Options 0-10V:** EM/GEN, GTD or Battery Back up
- **DALI:** EM/GEN, GTD or Battery Back up
- **LUTRON:** EM/GEN, GTD or Battery Back up

INTEGRATED SENSORS: Integrated PIR (Passive Infrared) Occupancy (**OBO**) or Daylight Sensors (**OBD**) available with Flush and Bottom Glow downlight diffusers. PIR sensors not recommended for stairwell applications. Refer to Occupancy Sensor & Daylight Sensor tech sheet and the Embedded Intelligence landing page for more information and additional sensor options.

FINISHES: Finelite Signal White (**SW**) powder coat, Finelite Black (RAL 9005) with semi gloss fine texture (**FB**), and Satin Aluminum (**SA**) are standard. Optional Adder: 179 RAL colors⁹ are available.

LABELS: Luminaire and electrical components are ETL-listed conforming to UL 1598 in the U.S.A. and CAN/CSA C22.2 No. 250.0 in Canada. In accordance with NEC Code 410.130 (G), this luminaire contains an internal driver disconnect. UL 924 and UL 2108 - PoE options available on request. These fixtures are rated for Damp Location. Chicago Plenum options available for C1, C2, or C3 suspension using our GridBox. Finelite products use electronic components that are RoHS compliant, and the mechanical components of the luminaire have been verified to not knowingly contain any restricted substances listed per RoHS Directive 2015/863. Consult factory for tailored lighting options. Finelite makes the specification process easy when putting healthier products on your projects. Simply add - **RLA** (Red List Approved) or - **RLD** (Red List Declared) to your part number.

WEIGHT¹⁰: ID - 3.4 lb/ft; D - 2.8 lb/ft; I - 2.8 lb/ft; AM - 2.9 lb/ft (luminaire only)

DLC QUALIFIED: Contact factory

WARRANTY: 10-year performance-based warranty on all standard components. Optional accessories such as emergency battery packs are covered by their individual manufacturer warranties.

⁷ Available in Indirect/Direct Regressed & Direct Regressed only

⁸ Consult Finelite for Generator Transfer Device and Battery Backup fit

⁹ 20 business days lead time for color

¹⁰ Excludes Battery Back up and Generator Transfer Device weight

Submitted by:		Date:
Type:	Project:	
Ordering Info:		

High Performance 4" Aperture (HP-4) Wall Mount and Arm Mount

AESTHETIC OPTIONS

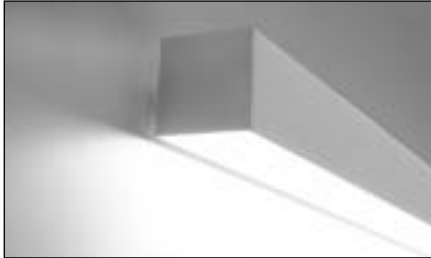

Flush Diffuser (F)¹

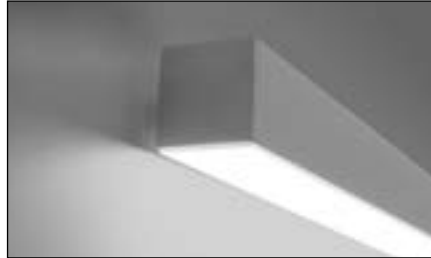

Bottom Glow Diffuser (BG)¹



1" Drop Down Lens (DL)¹



Flat Diffuser with 1" Regressed (RG-D)¹



Downlight Asymmetric Optic (DAO)¹
Externally flush



White Cross Blade Baffle (RG-WCB)¹

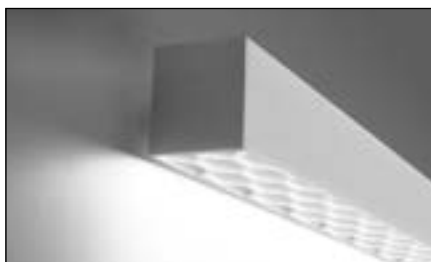

Hex Louver (RG-LHC)¹

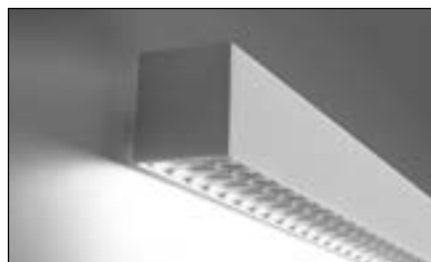

Hollowed Ellipse Louver (RG-LHE)¹

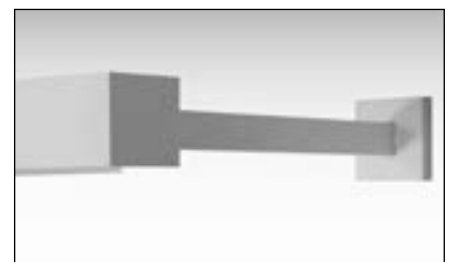

Kicker (K) - Wall Wash Arm Mount only

¹ Not available with Wall Wash

Submitted by:		Date:
Type:	Project:	
Ordering Info:		

High Performance 4" Aperture (HP-4) Wall Mount and Arm Mount

ASYMMETRIC OPTIONS

The diagrams below show a linear run from power feed to ender. Specifying ASY-L distributes light to the left or ASY-R distributes light to the right. For proper orientation: view luminaire from starter end when specifying the direction of the Asymmetric optic.

Asymmetric Left Optic (ASY-L)

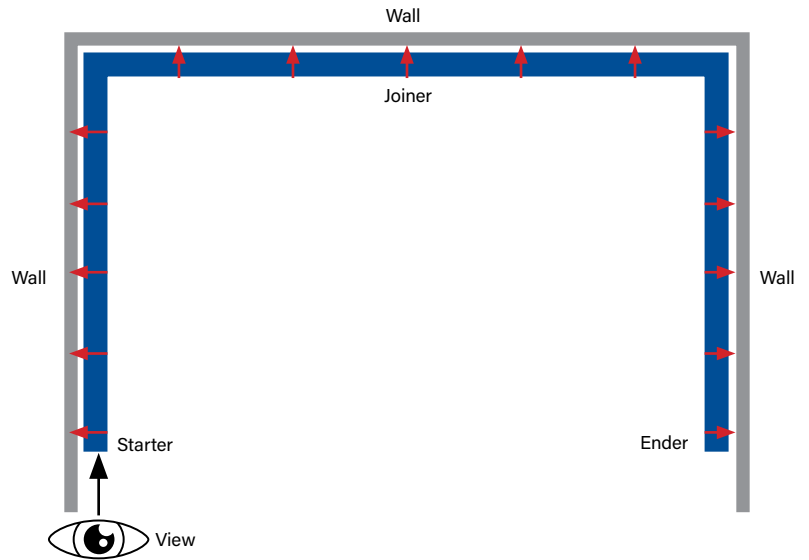
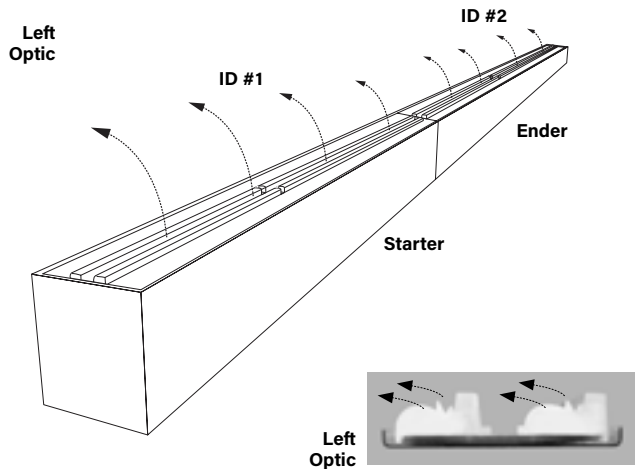

Asymmetric Right Optic (ASY-R)

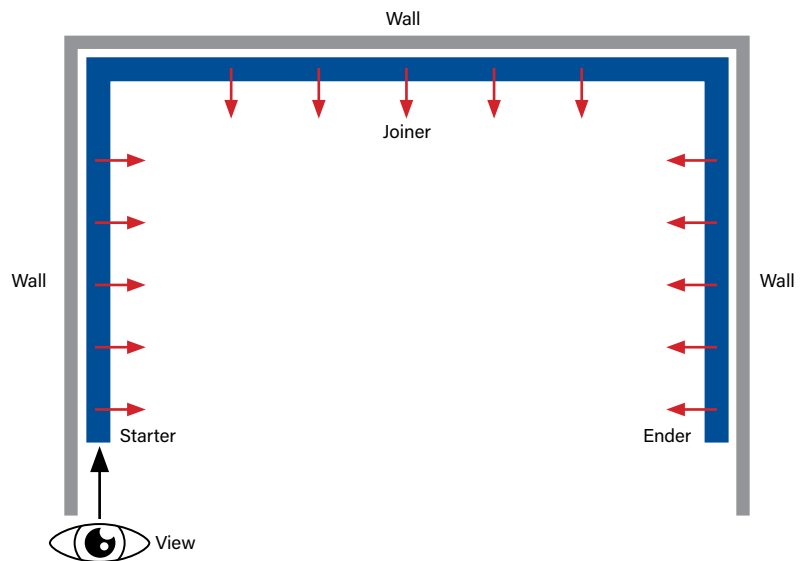
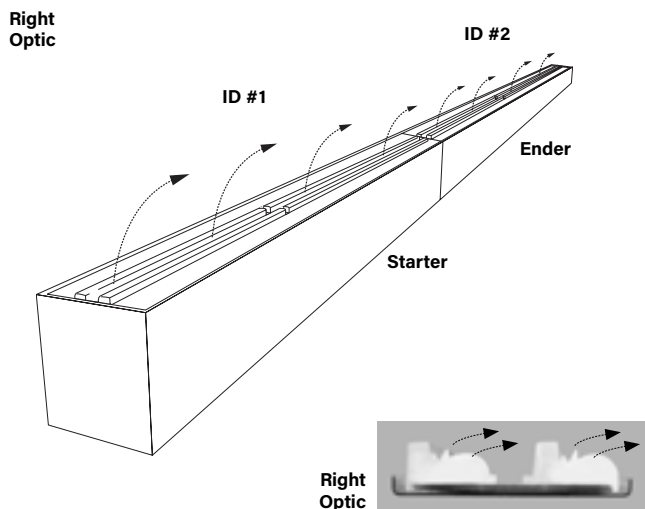

Submitted by:		Date:
Type:	Project:	
Ordering Info:		

High Performance 4" Aperture (HP-4) Wall Mount and Arm Mount

DOWNLIGHT ASYMMETRIC OPTIONS

The diagrams below show a linear run from power feed to ender. Specifying DAO-L distributes light to the left or DAO-R distributes light to the right. For proper orientation: view luminaire from starter end when specifying the direction of the Downlight Asymmetric optic.

Downlight Asymmetric Optic Left (DAO-L)

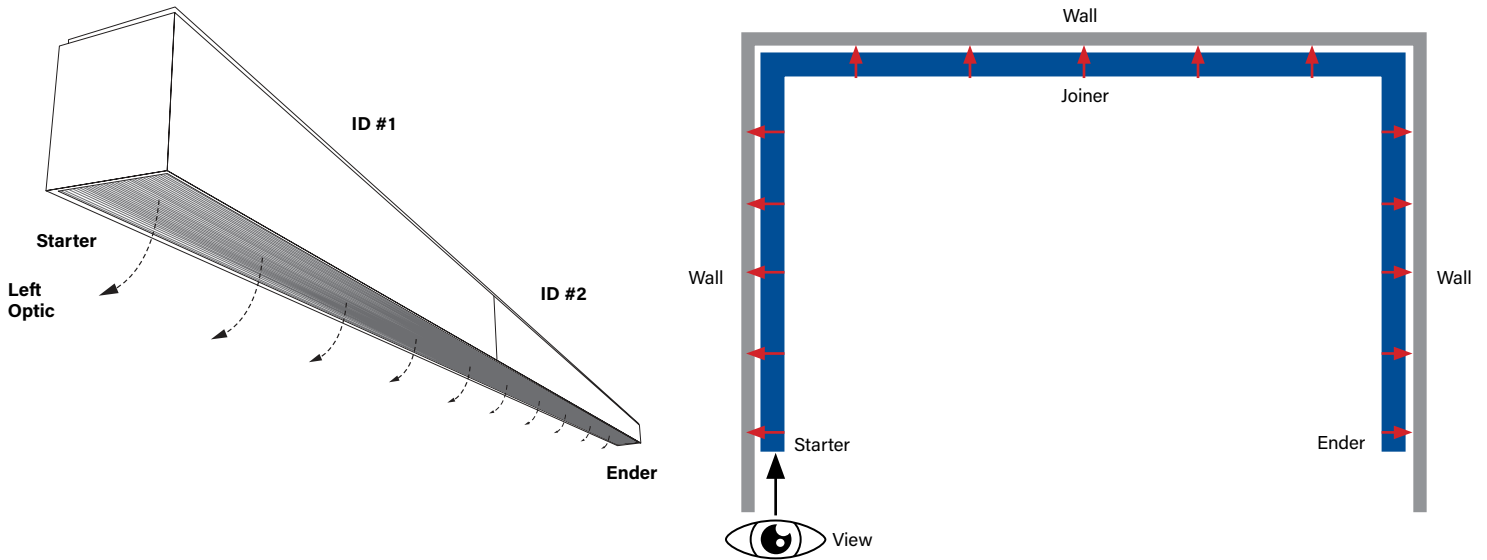

Downlight Asymmetric Optic Right (DAO-R)

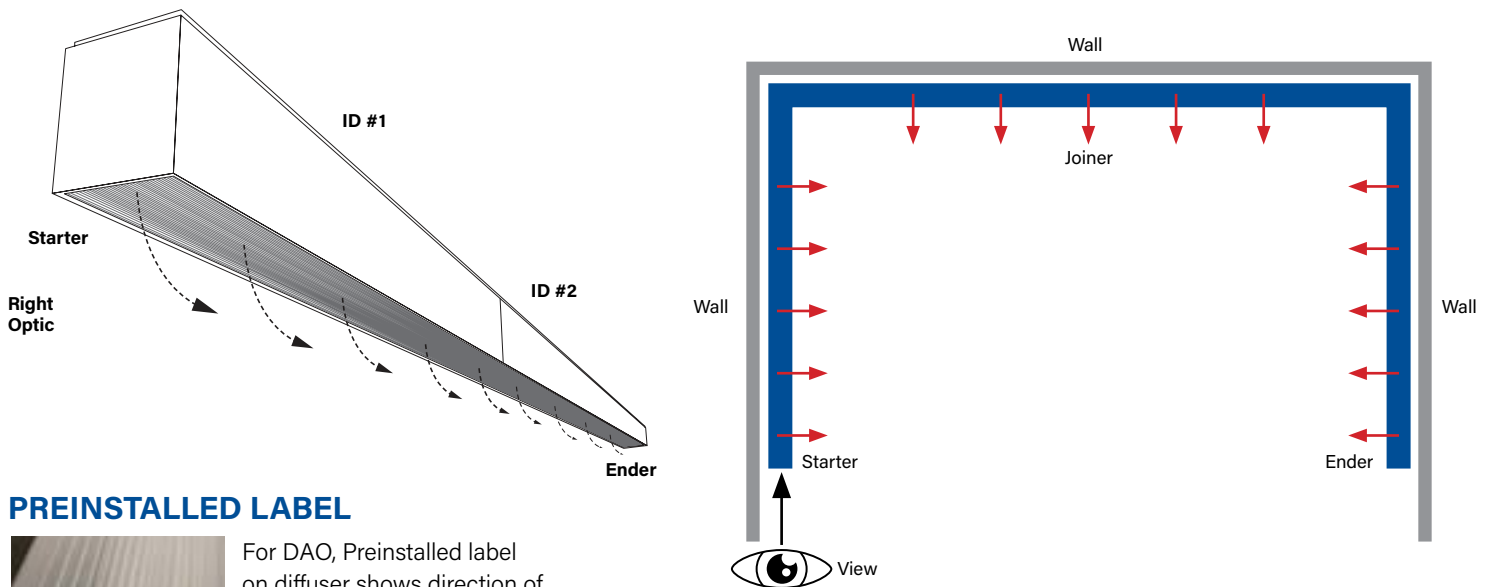

PREINSTALLED LABEL



For DAO, Preinstalled label on diffuser shows direction of light. Remove after installation.

Submitted by:		Date:
Type:	Project:	
Ordering Info:		

High Performance 4" Aperture (HP-4) Wall Mount and Arm Mount

WALL WASH ARM MOUNT - Run Lengths & Mounting Location Examples

Tailored Lengths Available Down To 1/16" (±1/32")

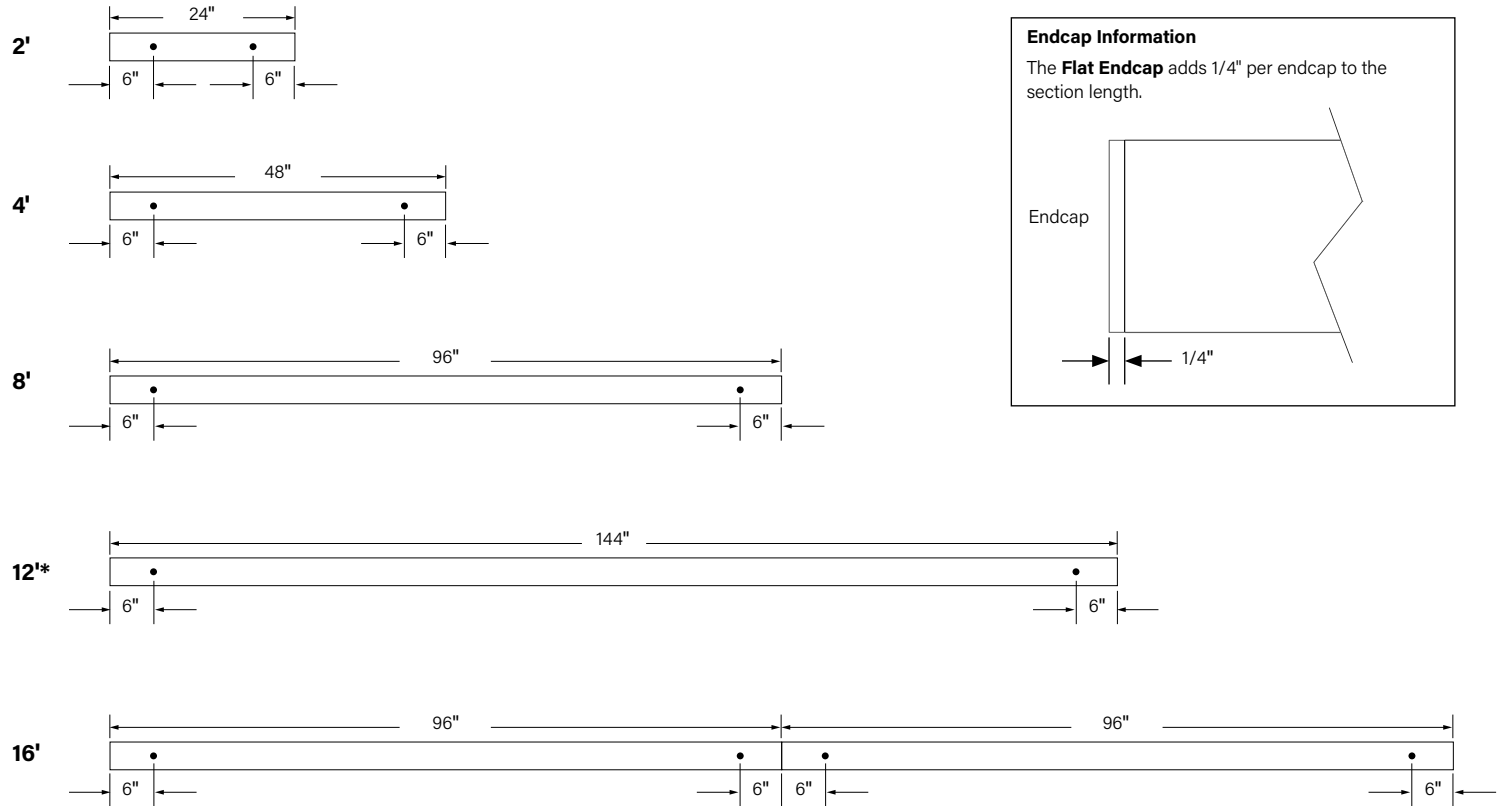

• = Bracket Location
* = 12' Maximum spacing for two Arm Mount supports

Submitted by:		Date:
Type:	Project:	
Ordering Info:		

High Performance 4" Aperture (HP-4) Wall Mount and Arm Mount

Indirect/Direct Photometry - 4' Luminaire 3500K

HP4-WM-ID-4'-V-V-835-ASY-R-DAO

Uplight: Asymmetric Right / **Downlight:** Downlight Asymmetric Optic

Distribution: 53% Up (V) / 47% Down (V)

Efficacy: 115 lm/W

Uplight: 4436 lumens (1108 lumens/foot)

Downlight: 3884 lumens (971 lumens/foot)

Total luminaire output: 8320 lumens (2080 lm/ft)
72.5 watts (18.1 W/ft)

CRI: 80 / CCT: 3500K

ITL LM79 Report 89988 and 94331

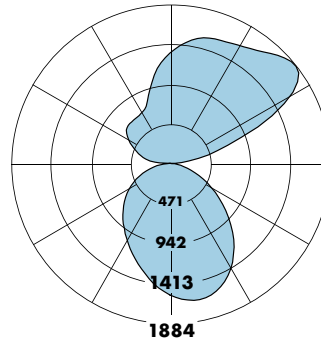

CANDELA DISTRIBUTION						
	0.0	22.5	45.0	67.5	90.0	FLUX
0	1552	1552	1552	1552	1552	
5	1609	1605	1591	1569	1543	146
15	1641	1635	1599	1533	1468	413
25	1538	1537	1506	1415	1323	609
35	1315	1325	1314	1224	1116	704
45	1019	1039	1052	976	872	692
55	710	733	759	707	629	587
65	438	452	476	450	404	423
75	216	224	239	230	214	239
85	57	57	62	62	63	70
90	0	0	0	0	0	
95	142	145	146	149	57	146
105	582	627	647	445	207	432
115	1335	1341	1134	661	369	692
125	1861	1728	1288	811	545	796
135	1803	1664	1318	959	724	743
145	1657	1575	1367	1118	909	641
155	1581	1541	1432	1254	1084	513
165	1537	1515	1446	1332	1220	345
175	1401	1392	1366	1332	1293	123
180	1302	1302	1302	1302	1302	

Sample Lumen Adjustment Calculation

Lumen Adjustment Factors 80 CRI

3000K	0.985
3500K	1.000
4000K	1.032

Lumen Adjustment Factors 90 CRI

3000K	0.746
3500K	0.760
4000K	0.789

High Output (H) / Standard Output (S), 4000K, 90 CRI

Lumen Adjustment Factor: 0.789

Total Light Output: 5040 lm x 0.789 = 3977 lm

Total Light Output per Foot: 1213 lm/ft x 0.789 = 994 lm/ft.

watts/foot: 10.5 W/ft.

$$\text{Efficacy} = \frac{994 \frac{\text{lm}}{\text{ft.}}}{10.5 \frac{\text{W}}{\text{ft.}}} = 95 \text{ lm/W}$$

Total Light Output, 3500K, 80 CRI (Lumens) - 4' Luminaire

	1S ¹	1B ¹	1H ¹	1V ²
1S ¹	3406 [153% 47%↓]	3873 [159% 41%↓]	5040 [169% 31%↓]	6026 [174% 26%↓]
1B ¹	3815 [147% 52%↓]	4282 [153% 47%↓]	5449 [163% 37%↓]	6435 [169% 31%↓]
1H ¹	4837 [138% 62%↓]	5304 [143% 57%↓]	6471 [153% 47%↓]	7457 [160% 40%↓]
1V ²	5700 [132% 68%↓]	6167 [137% 63%↓]	7344 [147% 53%↓]	8320 [153% 47%↓]

Light Output, 3500K, 80 CRI (Lumens Per Foot)

	1S ¹	1B ¹	1H ¹	1V ²
1S ¹	851	968	1260	1506
1B ¹	954	1070	1362	1609
1H ¹	1209	1326	1618	1864
1V ²	1425	1542	1834	1995

Power, 3500K (Watts Per Foot)

	1S ¹	1B ¹	1H ¹	1V ²
1S ¹	7.1	8.1	10.5	12.6
1B ¹	8.1	9.0	11.5	13.6
1H ¹	10.5	11.5	13.9	16.0
1V ²	12.6	13.6	16.0	18.1

Efficacy, 3500K, 80 CRI (Lumens Per Watt)

	1S ¹	1B ¹	1H ¹	1V ²
1S ¹	120	120	120	120
1B ¹	118	119	119	119
1H ¹	115	116	116	116
1V ²	113	114	115	115

Wattage is Real Power. If you would like additional details to calculate Apparent Power, please contact your local Finelite representative.

S - Standard Output, B - Boosted Standard Output, H - High Output, V - Very High Output

¹ Family Correlation based on 4' luminaire 3500K Very High Output (V) test - 120V.

² Based on ITL report: 89988, 94331

Submitted by:		Date:
Type:	Project:	
Ordering Info:		

High Performance 4" Aperture (HP-4) Wall Mount and Arm Mount

Indirect/Direct Photometry - 4' Luminaire 3500K

HP4-WM-ID-4'-V-V-835

Uplight: Flush Diffuser / **Downlight:** Flush Diffuser

Distribution: 53% Up (V) / 47% Down (V)

Efficacy: 106 lm/W

Uplight: 4180 lumens (1045 lumens/foot)

Downlight: 3706 lumens (927 lumens/foot)

Total luminaire output: 7886 lumens (1972 lm/ft)
74.1 watts (18.5 W/ft)

Peak Candela Value: 1600 @ 180°

CRI: 80 / CCT: 3500K

ITL LM79 Report 85125

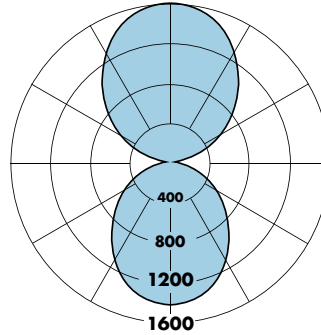

CANDELA DISTRIBUTION						
	0.0	22.5	45	67.5	90	Flux
0	1443	1443	1443	1443	1443	
5	1433	1434	1434	1433	1434	136
15	1368	1360	1365	1363	1356	384
25	1239	1225	1228	1224	1216	564
35	1062	1050	1049	1040	1034	654
45	859	850	847	838	832	652
55	647	640	637	628	624	568
65	435	430	429	424	422	424
75	233	234	233	234	232	248
85	65	67	68	69	70	76
90	0	0	0	0	0	
95	71	72	76	81	82	86
105	257	261	266	270	269	281
115	485	483	485	490	486	482
125	723	726	726	720	717	646
135	963	958	961	958	951	739
145	1189	1177	1185	1179	1172	738
155	1377	1367	1374	1368	1363	631
165	1517	1510	1514	1511	1510	426
175	1590	1590	1590	1589	1590	151
180	1600	1600	1600	1600	1600	

Sample Lumen Adjustment Calculation

Lumen Adjustment Factors 80 CRI

3000K	0.985
3500K	1.000
4000K	1.032

Lumen Adjustment Factors 90 CRI

3000K	0.746
3500K	0.760
4000K	0.789

High Output (H) / Standard Output (S), 4000K, 90 CRI

Lumen Adjustment Factor: 0.789

Total Light Output: 4768 lm x 0.789 = 3762 lm

Total Light Output per Foot: 1192 lm/ft x 0.789 = 940 lm/ft.

watts/foot: 10.7 W/ft.

$$\text{Efficacy} = \frac{940 \frac{\text{lm}}{\text{ft}}}{10.7 \frac{\text{W}}{\text{ft}}} = 88 \text{ lm/W}$$

Total Light Output, 3500K, 80 CRI (Lumens) - 4' Luminaire

	↑S ¹	↑B ¹	↑H ¹	↑V ²
↓S ¹	3228 (153% 47%↓)	3668 (159% 41%↓)	4768 (168% 32%↓)	5697 (173% 27%↓)
↓B ¹	3618 (147% 53%↓)	4058 (153% 47%↓)	5158 (163% 37%↓)	6087 (169% 31%↓)
↓H ¹	4594 (137% 63%↓)	5034 (143% 57%↓)	6134 (153% 47%↓)	7062 (159% 41%↓)
↓V ²	5417 (132% 68%↓)	5857 (137% 63%↓)	6957 (147% 53%↓)	7886 (153% 47%↓)

Light Output, 3500K, 80 CRI (Lumens Per Foot)

	↑S ¹	↑B ¹	↑H ¹	↑V ²
↓S ¹	807	917	1192	1424
↓B ¹	905	1015	1290	1522
↓H ¹	1148	1258	1533	1766
↓V ²	1354	1464	1739	1972

Power, 3500K (Watts Per Foot)

	↑S ¹	↑B ¹	↑H ¹	↑V ²
↓S ¹	7.3	8.2	10.7	12.9
↓B ¹	8.2	9.2	11.7	13.9
↓H ¹	10.7	11.7	14.2	16.4
↓V ²	12.9	13.9	16.4	18.5

Efficacy, 3500K, 80 CRI (Lumens Per Watt)

	↑S ¹	↑B ¹	↑H ¹	↑V ²
↓S ¹	111	111	111	111
↓B ¹	110	110	110	110
↓H ¹	107	107	108	108
↓V ²	105	106	106	106

Wattage is Real Power. If you would like additional details to calculate Apparent Power, please contact your local Finelite representative.

S - Standard Output, B - Boosted Standard Output, H - High Output, V - Very High Output

¹ Family Correlation based on 4' luminaire 3500K Very High Output (V) test - 120V.

² Based on ITL report: 89125

Submitted by:		Date:
Type:	Project:	
Ordering Info:		

High Performance 4" Aperture (HP-4) Wall Mount and Arm Mount

Indirect/Direct Photometry - 4' Luminaire 3500K

HP4-WM-RG-ID-4'-V-V-835

Uplight: Flush Diffuser / **Downlight:** Regressed Diffuser

Distribution: 56% Up (V) / 44% Down (V)

Efficacy: 108 lm/W

Uplight: 4406 lumens (1102 lumens/foot)

Downlight: 3531 lumens (883 lumens/foot)

Total luminaire output: 7937 lumens (1984 lm/ft)
73.2 watts (18.3 W/ft)

Peak Candela Value: 1656 @ 180°

CRI: 80 / CCT: 3500K

ITL LM79 Report 90353

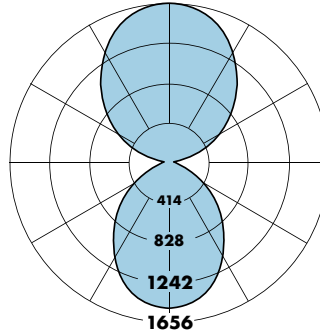

CANDELA DISTRIBUTION						
	0.0	22.5	45.0	67.5	90.0	FLUX
0	1507	1507	1507	1507	1507	
5	1497	1496	1496	1497	1498	142
15	1429	1419	1418	1410	1400	398
25	1293	1276	1259	1237	1227	579
35	1109	1087	1053	1020	1003	659
45	902	871	824	780	764	638
55	682	645	588	541	525	532
65	457	418	358	313	299	364
75	244	203	151	120	115	178
85	60	36	33	32	31	43
90	0	0	0	0	0	
95	75	78	81	84	85	91
105	276	281	287	293	293	303
115	514	516	523	528	526	516
125	65	764	768	772	774	687
135	1010	1003	1011	1016	1016	779
145	1241	1227	1240	1239	1237	773
155	1434	1421	1433	1431	1426	658
165	1574	1566	1571	1568	1565	442
175	1646	1646	1646	1645	1645	156
180	1656	1656	1656	1656	1656	

Sample Lumen Adjustment Calculation

Lumen Adjustment Factors 80 CRI

3000K	0.985
3500K	1.000
4000K	1.032

Lumen Adjustment Factors 90 CRI

3000K	0.746
3500K	0.760
4000K	0.789

High Output (H) / Standard Output (S), 4000K, 90 CRI

Lumen Adjustment Factor: 0.789

Total Light Output: 4872 lm x 0.789 = 3844 lm

Total Light Output per Foot: 1218 lm/ft x 0.789 = 961 lm/ft.

watts/foot: 10.6 W/ft.

$$\text{Efficacy} = \frac{961 \frac{\text{lm}}{\text{ft.}}}{10.6 \frac{\text{W}}{\text{ft.}}} = 91 \text{ lm/W}$$

Total Light Output, 3500K, 80 CRI (Lumens) - 4' Luminaire

	↑S ¹	↑B ¹	↑H ¹	↑V ²
↓S ¹	3249 [↑55% 45%↓]	3713 [↑61% 39%↓]	4872 [↑70% 30%↓]	5851 [↑75% 25%↓]
↓B ¹	3621 [↑50% 50%↓]	4085 [↑55% 45%↓]	5244 [↑65% 35%↓]	6223 [↑71% 29%↓]
↓H ¹	4550 [↑40% 60%↓]	5014 [↑45% 55%↓]	6173 [↑56% 44%↓]	7152 [↑62% 38%↓]
↓V ²	5335 [↑34% 66%↓]	5798 [↑39% 61%↓]	6958 [↑49% 51%↓]	7937 [↑56% 44%↓]

Light Output, 3500K, 80 CRI (Lumens Per Foot)

	↑S ¹	↑B ¹	↑H ¹	↑V ²
↓S ¹	812	928	1218	1463
↓B ¹	905	1021	1311	1556
↓H ¹	1137	1253	1543	1788
↓V ²	1334	1450	1739	1984

Power, 3500K (Watts Per Foot)

	↑S ¹	↑B ¹	↑H ¹	↑V ²
↓S ¹	7.2	8.1	10.6	12.7
↓B ¹	8.1	9.1	11.6	13.7
↓H ¹	10.6	11.6	14.0	16.2
↓V ²	12.7	13.7	16.2	18.3

Efficacy, 3500K, 80 CRI (Lumens Per Watt)

	↑S ¹	↑B ¹	↑H ¹	↑V ²
↓S ¹	113	114	115	115
↓B ¹	111	112	113	114
↓H ¹	107	108	110	111
↓V ²	105	106	108	108

Wattage is Real Power. If you would like additional details to calculate Apparent Power, please contact your local Finelite representative.

S - Standard Output, B - Boosted Standard Output, H - High Output, V - Very High Output

¹ Family Correlation based on 4' luminaire 3500K Very High Output (V) test - 120V.

² Based on ITL report: 90353

Submitted by:		Date:
Type:	Project:	
Ordering Info:		

High Performance 4" Aperture (HP-4) Wall Mount and Arm Mount

Direct Photometry - 4' Luminaire 3500K

HP4-WM-D-4'-V-835

Downlight: Flush Diffuser

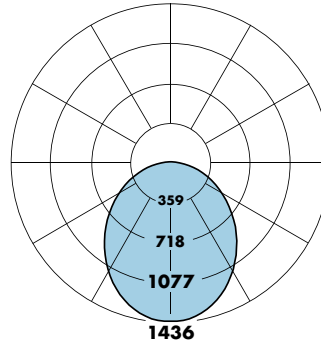
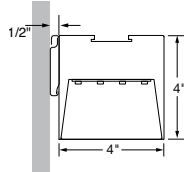

CANDELA DISTRIBUTION						
	0.0	22.5	45.0	67.5	90.0	FLUX
0	1436	1436	1436	1436	1436	
5	1428	1428	1427	1427	1427	135
15	1363	1353	1358	1357	1350	382
25	1236	1221	1226	1219	1212	563
35	1060	1047	1048	1037	1030	653
45	859	849	848	836	831	652
55	647	639	637	628	623	568
65	434	432	431	425	424	425
75	236	236	237	235	236	250
85	67	68	69	70	69	77
90	0	0	0	0	0	

Efficacy: 100 lm/W

Total luminaire output: 3705 lumens (926 lm/ft)
37 watts (9.3 W/ft)

Peak Candela Value: 1436 @ 0°

CRI: 80 / CCT: 3500K

ITL LM79 Report 85124

Total Light Output, 3500K, 80 CRI (Lumens) - 4' Luminaire

S ¹	B ¹	H ¹	V ²
1517	1907	2882	3705

Light Output, 3500K, 80 CRI (Lumens Per Foot)

S ¹	B ¹	H ¹	V ²
379	477	720	926

Power, 3500K (Watts Per Foot)

S ¹	B ¹	H ¹	V ²
3.6	4.6	7.1	9.3

Efficacy, 3500K, 80 CRI (Lumens Per Watt)

S ¹	B ¹	H ¹	V ²
105	107	102	100

Sample Lumen Adjustment Calculation

Lumen Adjustment Factors 80 CRI

3000K	0.985
3500K	1.000
4000K	1.032

Lumen Adjustment Factors 90 CRI

3000K	0.746
3500K	0.760
4000K	0.789

High Output (H), 4000K, 90 CRI

Lumen Adjustment Factor: 0.789

Total Light Output: 2882 lm x 0.789 = 2274 lm

Total Light Output per Foot: 720 lm/ft x 0.789 = 568 lm/ft.

watts/foot: 71 W/ft.

$$\text{Efficacy} = \frac{568 \frac{\text{lm}}{\text{ft.}}}{71 \frac{\text{W}}{\text{ft.}}} = 80 \text{ lm/W}$$

Wattage is Real Power. If you would like additional details to calculate Apparent Power, please contact your local Finelite representative.

S - Standard Output, B - Boosted Standard Output, H - High Output, V - Very High Output

¹ Family Correlation based on 4' luminaire 3500K Very High Output (V) test - 120V.

² Based on ITL report: 85124

Submitted by:		Date:
Type:	Project:	
Ordering Info:		

High Performance 4" Aperture (HP-4) Wall Mount and Arm Mount

Direct Photometry - 4' Luminaire 3500K

HP4-WM-D-4'-V-835-DAO

Downlight: Downlight Asymmetric Optic

Efficacy: 109 lm/W

Total luminaire output: 3884 lumens (971 lm/ft)
35.6 watts (8.9 W/ft)

Peak Candela Value: 1645 @ 12.5°

CRI: 80 / CCT: 3500K

ITL LM79 Report 94331

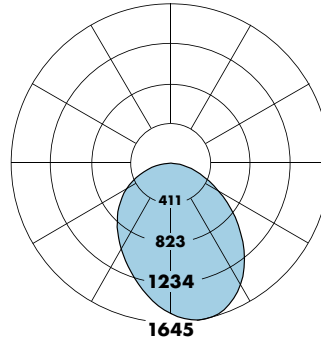

CANDELA DISTRIBUTION						
	0.0	22.5	45.0	67.5	90.0	Flux
0	1552	1552	1552	1552	1552	
5	1609	1591	1543	1494	1476	146
15	1641	1599	1468	1341	1292	413
25	1538	1506	1323	1153	1110	609
35	1315	1314	1116	960	939	704
45	1019	1052	872	768	779	691
55	710	759	629	578	616	587
65	438	476	404	391	436	423
75	216	239	214	218	248	239
85	57	62	63	64	70	70
90	0	0	0	0	0	

Total Light Output, 3500K, 80 CRI (Lumens) - 4' Luminaire

S ¹	B ¹	H ¹	V ²
1590	1999	3021	3884

Light Output, 3500K, 80 CRI (Lumens Per Foot)

S ¹	B ¹	H ¹	V ²
397	500	755	971

Power, 3500K (Watts Per Foot)

S ¹	B ¹	H ¹	V ²
3.5	4.4	6.8	8.9

Efficacy, 3500K, 80 CRI (Lumens Per Watt)

S ¹	B ¹	H ¹	V ²
114	113	111	109

Sample Lumen Adjustment Calculation

Lumen Adjustment Factors 80 CRI

3000K	0.985
3500K	1.000
4000K	1.032

Lumen Adjustment Factors 90 CRI

3000K	0.746
3500K	0.760
4000K	0.789

High Output (H), 4000K, 90 CRI

Lumen Adjustment Factor: 0.789

Total Light Output: 3021 lm x 0.789 = 2384 lm

Total Light Output per Foot: 755 lm/ft x 0.789 = 596 lm/ft.

watts/foot: 6.8 W/ft.

$$\text{Efficacy} = \frac{596 \frac{\text{lm}}{\text{ft.}}}{6.8 \frac{\text{W}}{\text{ft.}}} = 88 \text{ lm/W}$$

Wattage is Real Power. If you would like additional details to calculate Apparent Power, please contact your local Finelite representative.

S - Standard Output, B - Boosted Standard Output, H - High Output, V - Very High Output

¹ Family Correlation based on 4' luminaire 3500K Very High Output (V) test - 120V.

² Based on ITL report: 94331

Submitted by:		Date:
Type:	Project:	
Ordering Info:		

High Performance 4" Aperture (HP-4) Wall Mount and Arm Mount

Indirect Photometry - 4' Luminaire 3500K

HP4-WM-I-4'-V-835

Uplight: Flush Diffuser

Efficacy: 112 lm/W

Total luminaire output: 4114 lumens (1029 lm/ft)
37 watts (9.2 W/ft)

Peak Candela Value: 1552 @ 180°

CRI: 80 / CCT: 3500K

ITL LM79 Report 85127

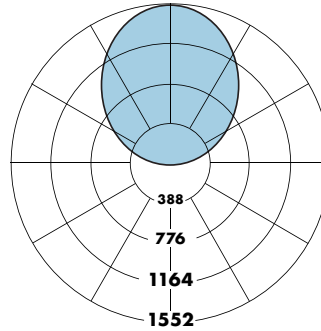

CANDELA DISTRIBUTION						
	0.0	22.5	45.0	67.5	90.0	Flux
90	0	0	0	0	0	
95	76	77	79	80	80	88
105	264	263	267	270	269	283
115	487	481	482	489	484	479
125	714	715	714	708	710	637
135	943	947	947	940	937	727
145	1161	1151	1166	1155	1151	724
155	1343	1332	1341	1338	1331	616
165	1475	1467	1473	1471	1468	414
175	1542	1542	1543	1543	1542	146
180	1552	1552	1552	1552	1552	

Sample Lumen Adjustment Calculation

Lumen Adjustment Factors 80 CRI

3000K	0.985
3500K	1.000
4000K	1.032

Lumen Adjustment Factors 90 CRI

3000K	0.746
3500K	0.760
4000K	0.789

High Output (H), 4000K, 90 CRI

Lumen Adjustment Factor: 0.789

Total Light Output: 3200 lm x 0.789 = 2525 lm

Total Light Output per Foot: 800 lm/ft x 0.789 = 631 lm/ft.

watts/foot: 71 W/ft.

$$\text{Efficacy} = \frac{631 \frac{\text{lm}}{\text{ft}}}{71 \frac{\text{W}}{\text{ft}}} = 89 \text{ lm/W}$$

Total Light Output, 3500K, 80 CRI (Lumens) - 4' Luminaire

S ¹	B ¹	H ¹	V ²
1684	2117	3200	4114

Light Output, 3500K, 80 CRI (Lumens Per Foot)

S ¹	B ¹	H ¹	V ²
421	529	800	1029

Power, 3500K (Watts Per Foot)

S ¹	B ¹	H ¹	V ²
3.6	4.6	7.1	9.2

Efficacy, 3500K, 80 CRI (Lumens Per Watt)

S ¹	B ¹	H ¹	V ²
117	116	114	112

Wattage is Real Power. If you would like additional details to calculate Apparent Power, please contact your local Finelite representative.

S - Standard Output, B - Boosted Standard Output, H - High Output, V - Very High Output

¹ Family Correlation based on 4' luminaire 3500K Very High Output (V) test - 120V.

² Based on ITL report: 86127

Submitted by:		Date:
Type:	Project:	
Ordering Info:		

High Performance 4" Aperture (HP-4) Wall Mount and Arm Mount

Wall Wash Direct Photometry - 4' Luminaire 3500K

HP4-AM-WW-D-K-4'-B-835

Downlight: With Kicker

Efficacy: 92 lm/W

Total luminaire output: 1816 lumens (454 lm/ft)
21.5 watts (5.4 W/ft)

Peak Candela Value: 1072 @ 35°

CRI: 80 / CCT: 3500K

ITL LM79 Report 85130

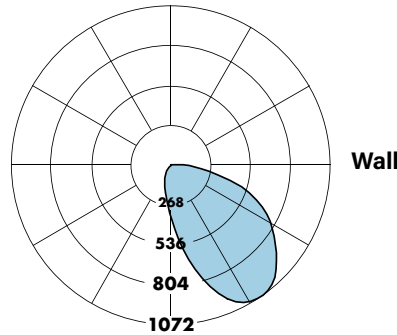

CANDELA DISTRIBUTION						
	0.0	22.5	45.0	67.5	90.0	FLUX
0	373	373	373	373	373	
5	495	456	374	306	281	37
15	791	649	366	209	175	121
25	1018	818	347	147	115	217
35	1072	896	315	101	72	294
45	996	848	271	62	35	328
55	842	708	214	28	6	311
65	673	536	149	5	6	259
75	407	363	84	4	5	173
85	157	137	25	0	0	70
90	75	54	0	0	0	

Sample Lumen Adjustment Calculation

Lumen Adjustment Factors 80 CRI

3000K	0.985
3500K	1.000
4000K	1.032

Lumen Adjustment Factors 90 CRI

3000K	0.746
3500K	0.760
4000K	0.789

High Output (H), 4000K, 90 CRI

Lumen Adjustment Factor: 0.789

Total Light Output: 1412 lm x 0.789 = 1114 lm

Total Light Output per Foot: 353 lm/ft x 0.789 = 279 lm/ft.

watts/foot: 3.8 W/ft.

$$\text{Efficacy} = \frac{279 \frac{\text{lm}}{\text{ft.}}}{3.8 \frac{\text{W}}{\text{ft.}}} = 73 \text{ lm/W}$$

Total Light Output, 3500K, 80 CRI (Lumens) - 4' Luminaire

S ¹	B ¹	H ¹	V ²
743	935	1412	1816

Light Output, 3500K, 80 CRI (Lumens Per Foot)

S ¹	B ¹	H ¹	V ²
186	234	353	454

Power, 3500K (Watts Per Foot)

S ¹	B ¹	H ¹	V ²
2.0	2.5	3.8	5.0

Efficacy, 3500K, 80 CRI (Lumens Per Foot)

S ¹	B ¹	H ¹	V ²
91	92	92	92

Wattage is Real Power. If you would like additional details to calculate Apparent Power, please contact your local Finelite representative.

S - Standard Output, B - Boosted Standard Output, H - High Output, V - Very High Output

¹ Family Correlation based on 4' luminaire 3500K Very High Output (V) test - 120V.

² Based on ITL report: 86130

Submitted by:		Date:
Type:	Project:	
Ordering Info:		

High Performance 4" Aperture (HP-4) Wall Mount and Arm Mount

Wall Wash Arm Mount Direct - Setback Info and Application Data

HP4-AM-WW-D-K-4'-B-835

Downlight: With Kicker

Total luminaire output: 935 lumens (234 lm/ft)
10.2 watts (2.6 W/ft)

CRI: 80 / CCT: 3500K

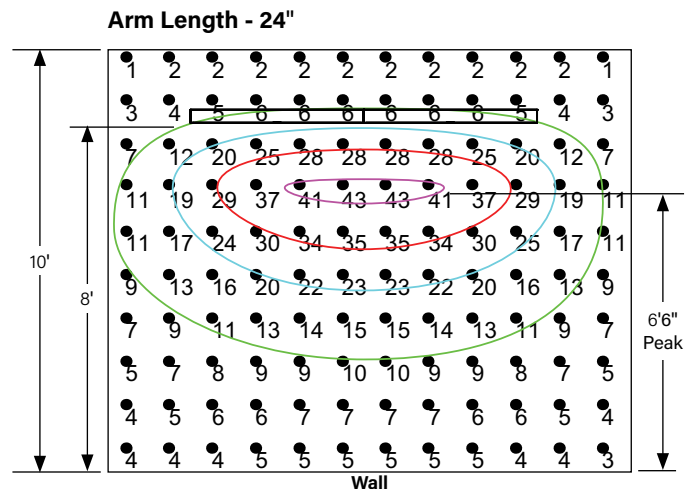
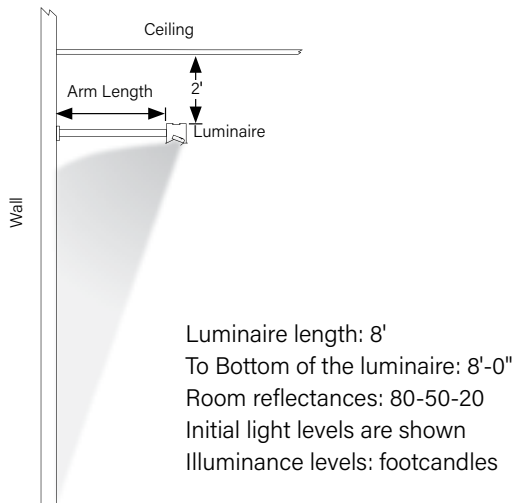

Downlight Asymmetric Optic - Setback Info and Application Data

HP-4-WM-ID-4'-S-S-835-ASY-DAO

Uplight: ASY

Downlight: DAO

Total luminaire output: 3406 lumens (852 lm/ft)
28.4 watts (7.1 W/ft)

CRI: 80 / CCT: 3500K

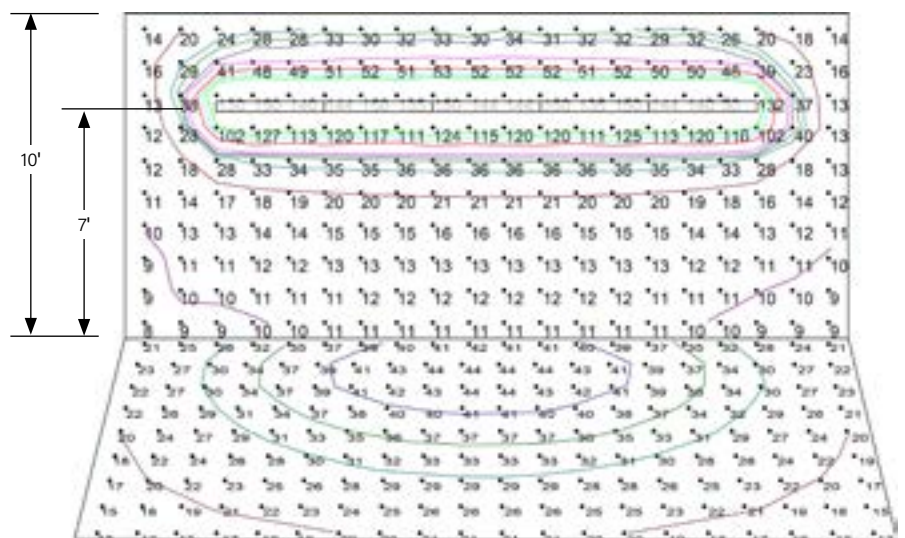
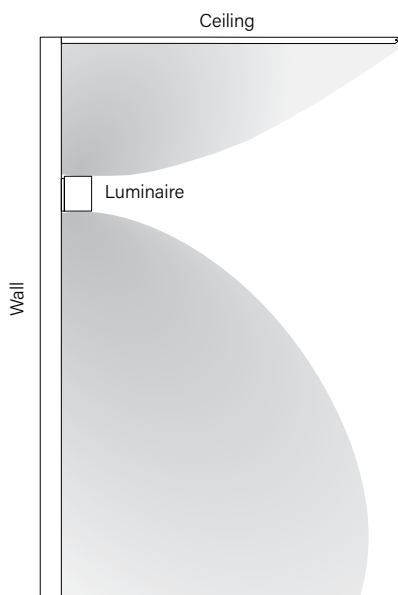

Submitted by:		Date:
Type:	Project:	
Ordering Info:		

0-10V Tunable White

Finelite's award-winning, contractor friendly Tunable White luminaires are available at low cost, with powerful and simple 0-10V tuning and intensity controls.

TUNABLE WHITE FEATURES

- CCT range: 2700K - 6500K
- Dimming Range: 100% to 10%
- CRI Options: 80 CRI or 90 CRI

LUMINAIRE FAMILY MODIFICATIONS/RESTRICTIONS

Surface Mount Direct	Section Lengths										
	2'	3'	4'	5'	6'	7'	8'	9'	10'	11'	12'
Output S,B,H,V Single Circuit	Rows can be comprised of 2'-12' sections. Tailored lengths available.										
Integral Battery Backup (BSL310LP)							✓		✓		✓

PHOTOMETRY

Apply a power adjustment factor to calculate wattage usage

POWER	CONVERSION FACTOR
	1.1X

(Example: a 50 watt luminaire in static white would draw 55 watts using 0-10V Tunable White)

WIRING DIAGRAM - DIMMABLE TO 10%

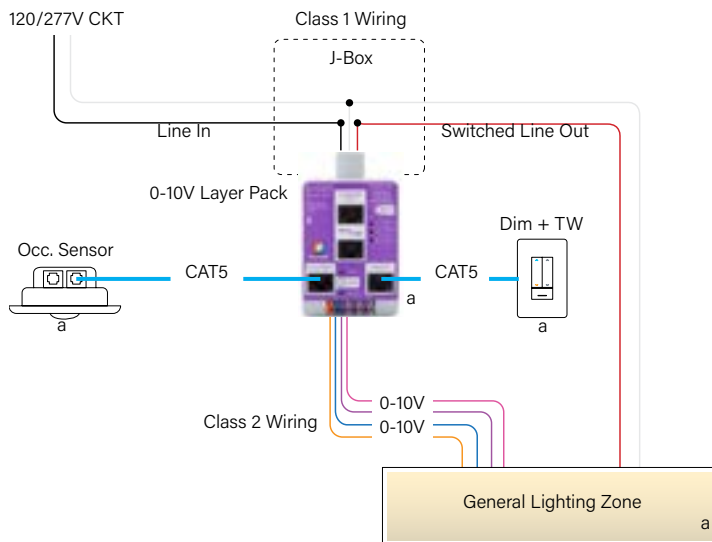

Luminaire Wiring

- **Purple (+) / Pink (-)** control wires are for intensity control
- **Orange (+) / Blue (-)** control wires are for Tunable White control

Note:

Load or Dim to Off options available.

DUAL FEED DETAIL

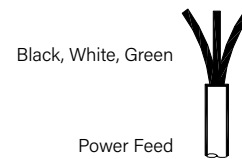

WIRING LEGEND		
Black	Hot	Line Voltage
White	Neutral	Line Voltage
Green	Ground	

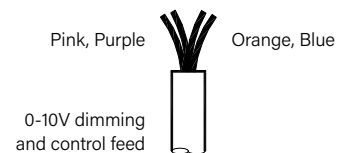

WIRING LEGEND		
Pink	Dimming	0-10V DC
Purple	Dimming	0-10V DC
Orange	TW	0-10V DC
Blue	TW	0-10V DC

