

# HP-4 Recessed / Regressed Mounting and Feed Guide

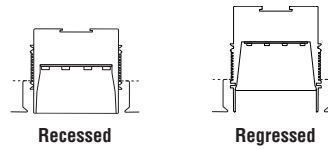

**FINELITE**<sup>®</sup>  
Better Lighting

Customer: \_\_\_\_\_ Job: \_\_\_\_\_ PO: \_\_\_\_\_

## RECESSED MOUNTING OPTIONS

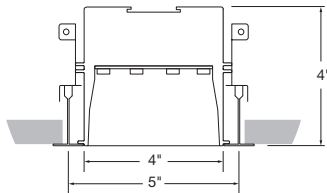

1" T-Bar (C1)

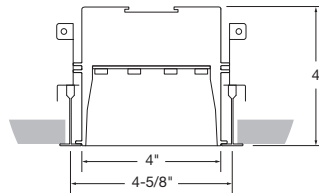

9/16" T-Bar (C2)

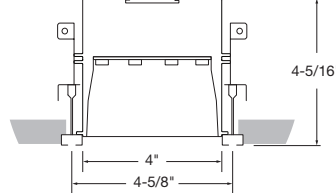

Standard Screw Slot (C3)

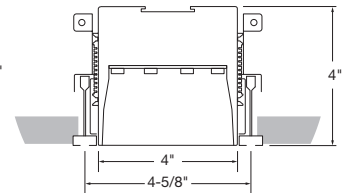

Flush Screw Slot (C3F)

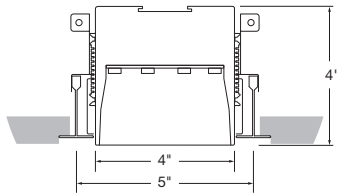

1" Tegular (C1T)

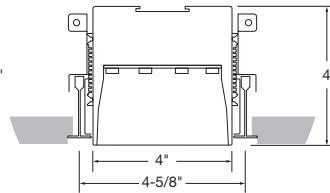

9/16" Tegular (C2T)

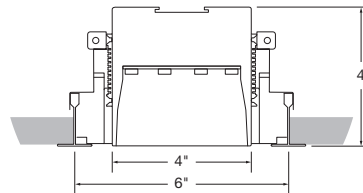

Tech Zone 6" (TZ6 C1)

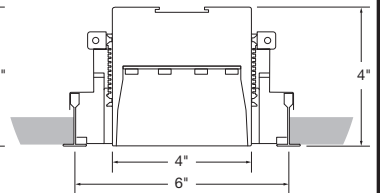

Tech Zone 6" (TZ6 C2)

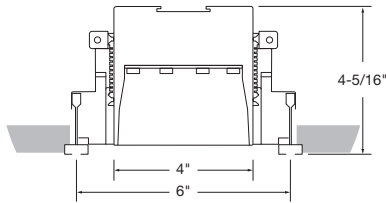

Tech Zone 6" (TZ6 C3)

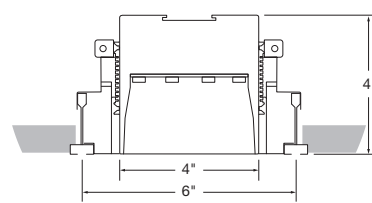

Tech Zone 6" (TZ6 C3F)

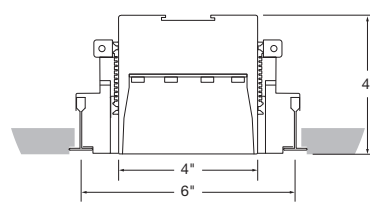

Tech Zone 6" (TZ6 C2T)

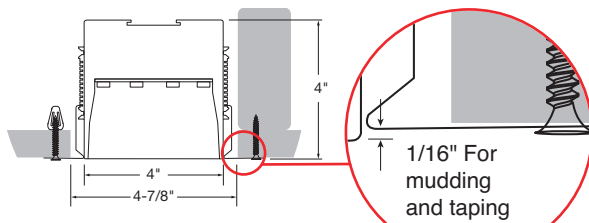

Spackle Flange (SF)

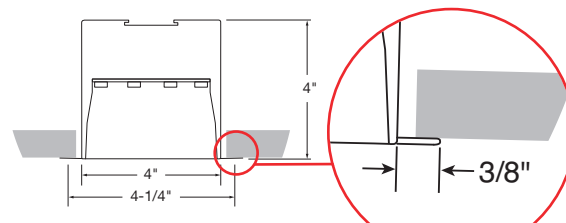

Visible Flange (VF)

### Version 1

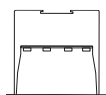

Ceiling Option VF

### Version 2

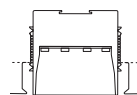

Ceiling Options C1T, C2T, C3F, SF, TZ6

### Version 3

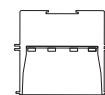

Ceiling Options C1, C2, C3

\* Note: +/- 1/16"

© 2018 FINELITE, INC. ALL RIGHTS RESERVED. CP00043\_V2\_08/18

# HP-4 Recessed / Regressed Mounting and Feed Guide

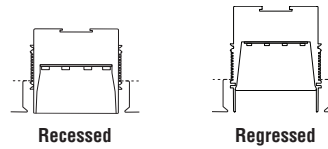

**FINELITE®**  
Better Lighting

## REGRESSED MOUNTING OPTIONS

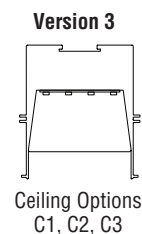
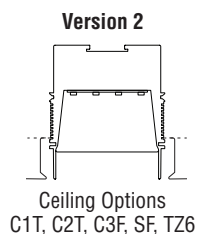
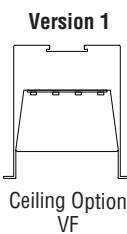
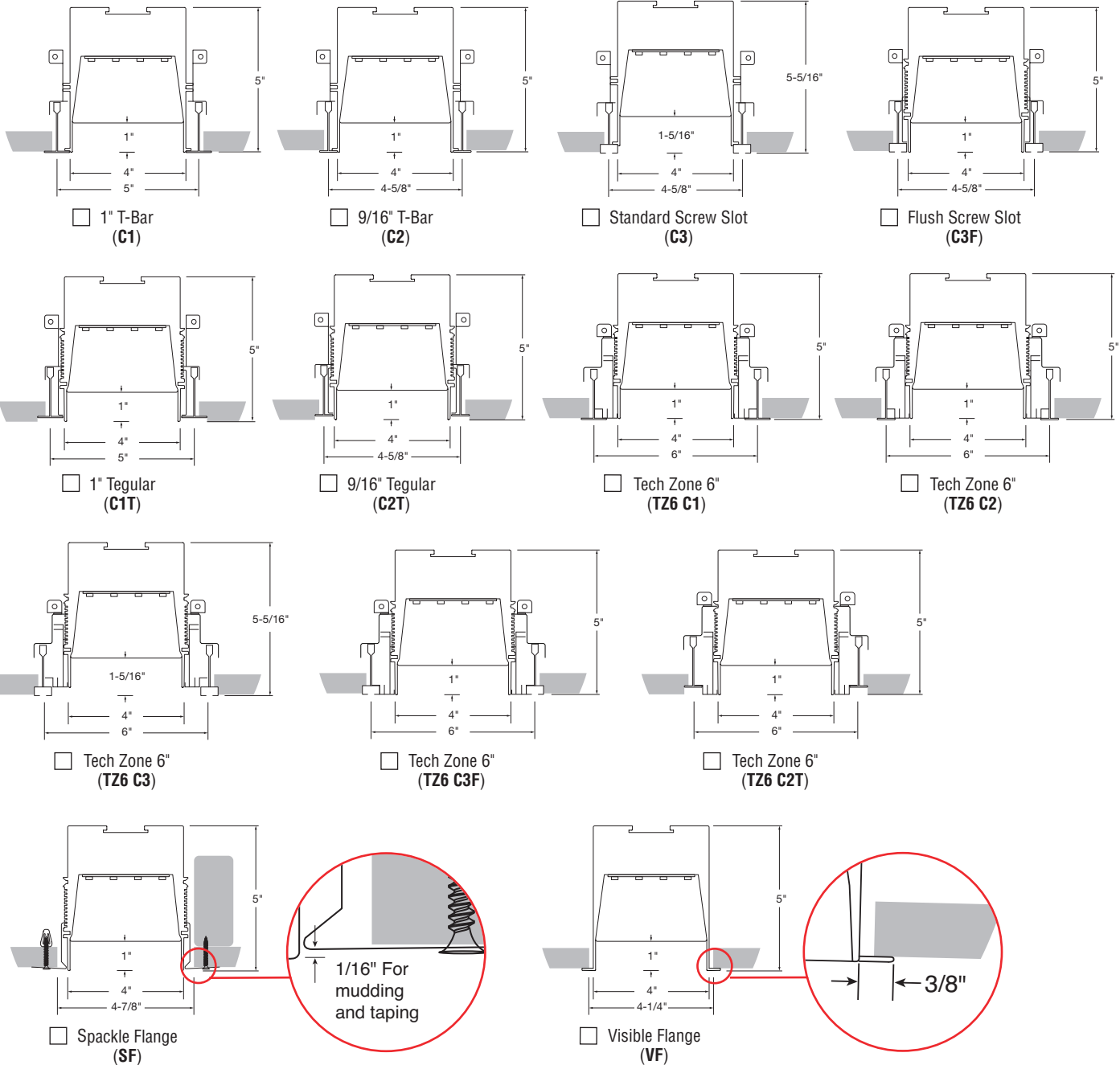

\* Note: +/- 1/16"

© 2018 FINELITE, INC. ALL RIGHTS RESERVED. CPG0043\_V2 08/18

# HP-4 Recessed / Regressed Mounting and Feed Guide

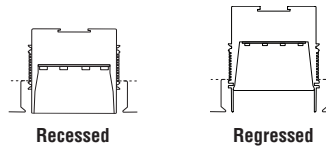

**FINELITE®**  
Better Lighting

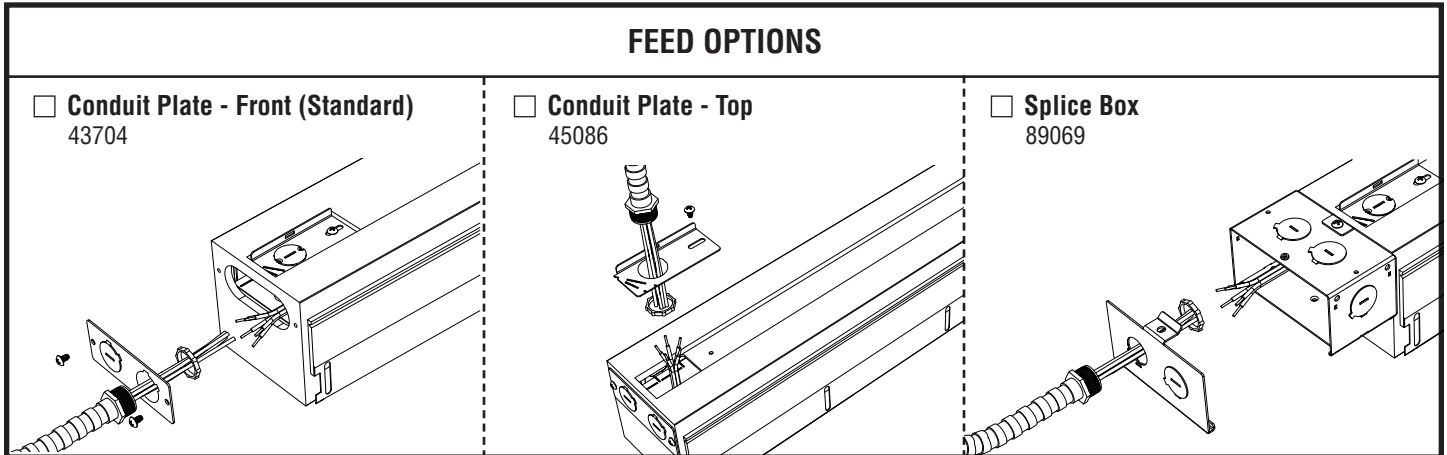

## Recessed T-Bar Luminaire Lengths (C1, C2, C3, C3F, C1T, C2T, TZ6)

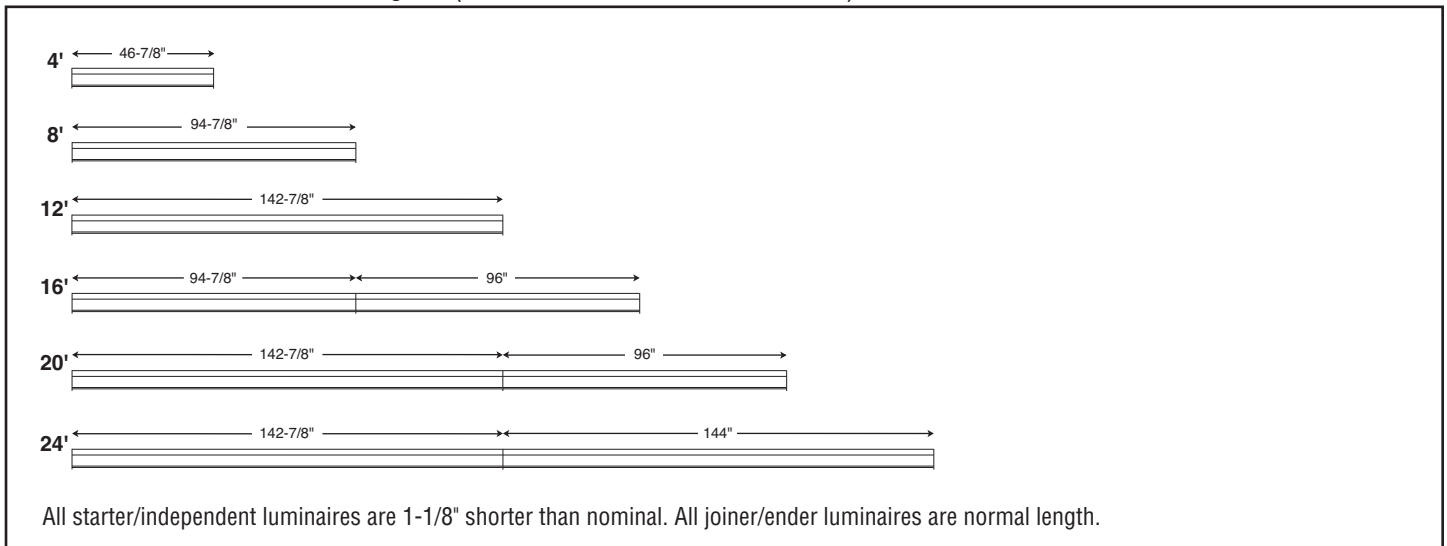

## Recessed Non-T-Bar Support Locations (VF, SF)

