

HP-4 Direct Installation Instructions

Regressed Luminaires Use Same Instructions

Overview

NOTES

- If luminaire contains a sensor or socket refer to the appropriate Addendum.
- All power connections should be installed according to local/national codes by a Certified Electrician.
- This installation requires **proper support** as each luminaire is being installed.
- **DO NOT attempt to join luminaires together on the floor.** Damage may result when lifted.



HELPFUL
VIDEOS



Louver
Removal



0-10V
Dimming



Effortless
Access



Socket Removal
& Installation



Universal &
Robust Joints



Simple
Plug-Together
Wiring

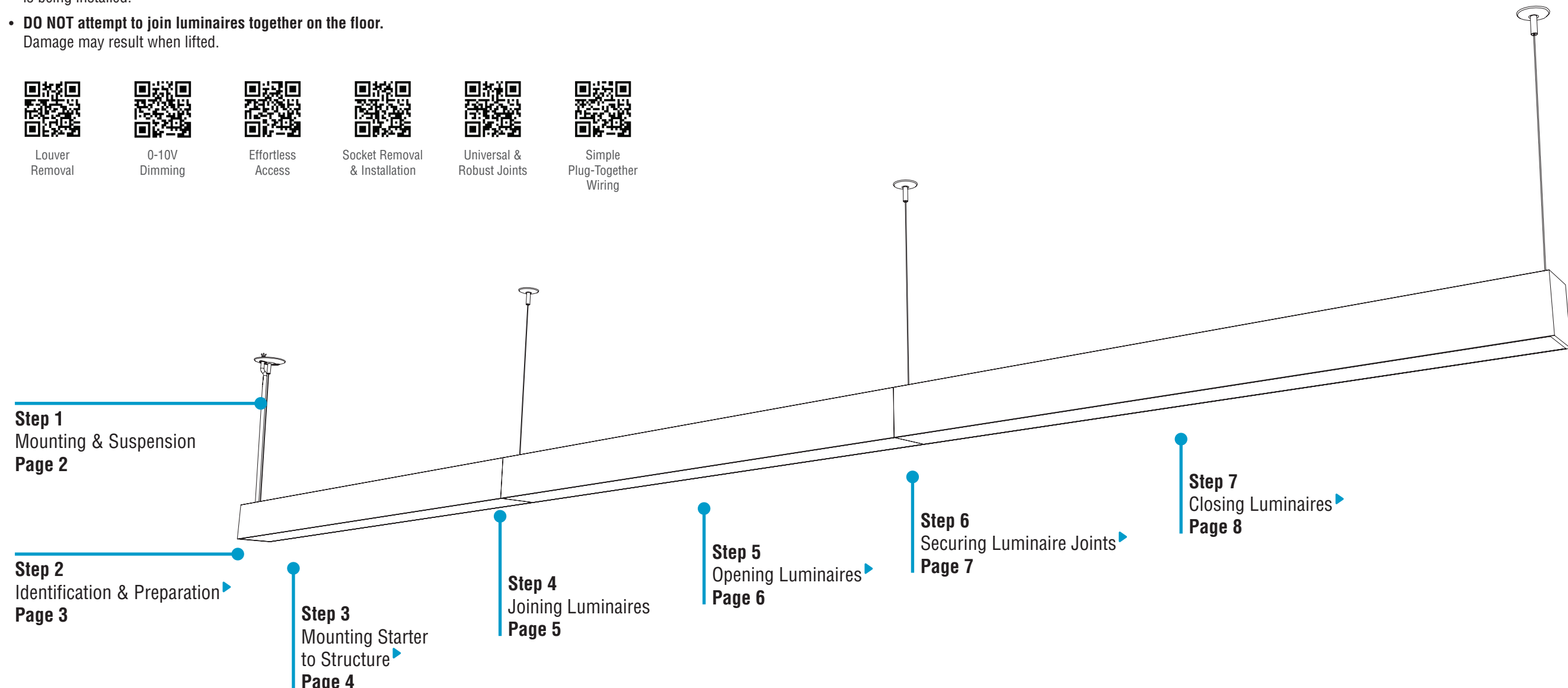

Step 1
Mounting & Suspension
Page 2

Step 2
Identification & Preparation
Page 3

Step 3
Mounting Starter
to Structure
Page 4

Step 4
Joining Luminaires
Page 5

Step 5
Opening Luminaires
Page 6

Step 6
Securing Luminaire Joints
Page 7

Step 7
Closing Luminaires
Page 8

HP-4 Direct Installation Instructions

Step 1 - Mounting & Suspension

Mounting Options

Option 1 T-Bar Mounting - GridBox™ and Caddy Clips

- Install GridBox™ and electrical conduit at feed locations.
- Install caddy clips at mounting point locations.
- All caddy clips are to be secured to structure, per local building codes.

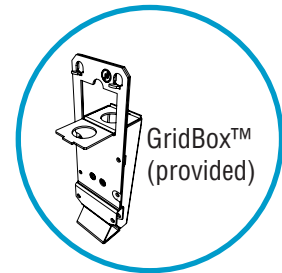

or

Option 2 Drywall (C4) or other hard surfaces* - J-Box and Anchor Bolts

- Install J-Box and electrical conduit at feed locations.
- Install anchor bolts at mounting point locations.
- All anchor bolts are to be secured to structure, per local building codes.

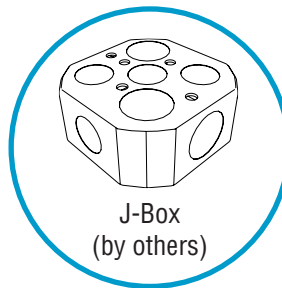

*Other hard surfaces include: wood, sheet metal panels, steel beams, concrete or masonry. Use hardware appropriate for each surface material type.

Suspension Locations

X = Suspension Dimensions

Refer to Record Drawings and building plans to determine exact mounting, suspension points, and power feed locations.

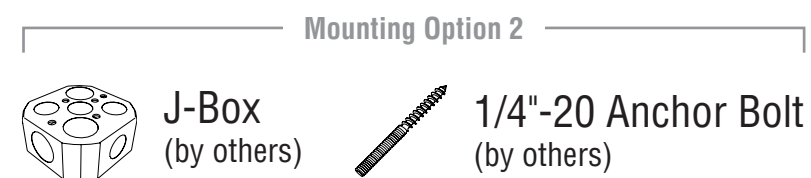
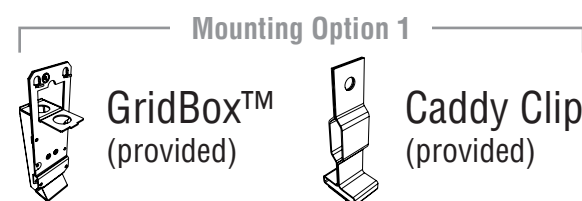
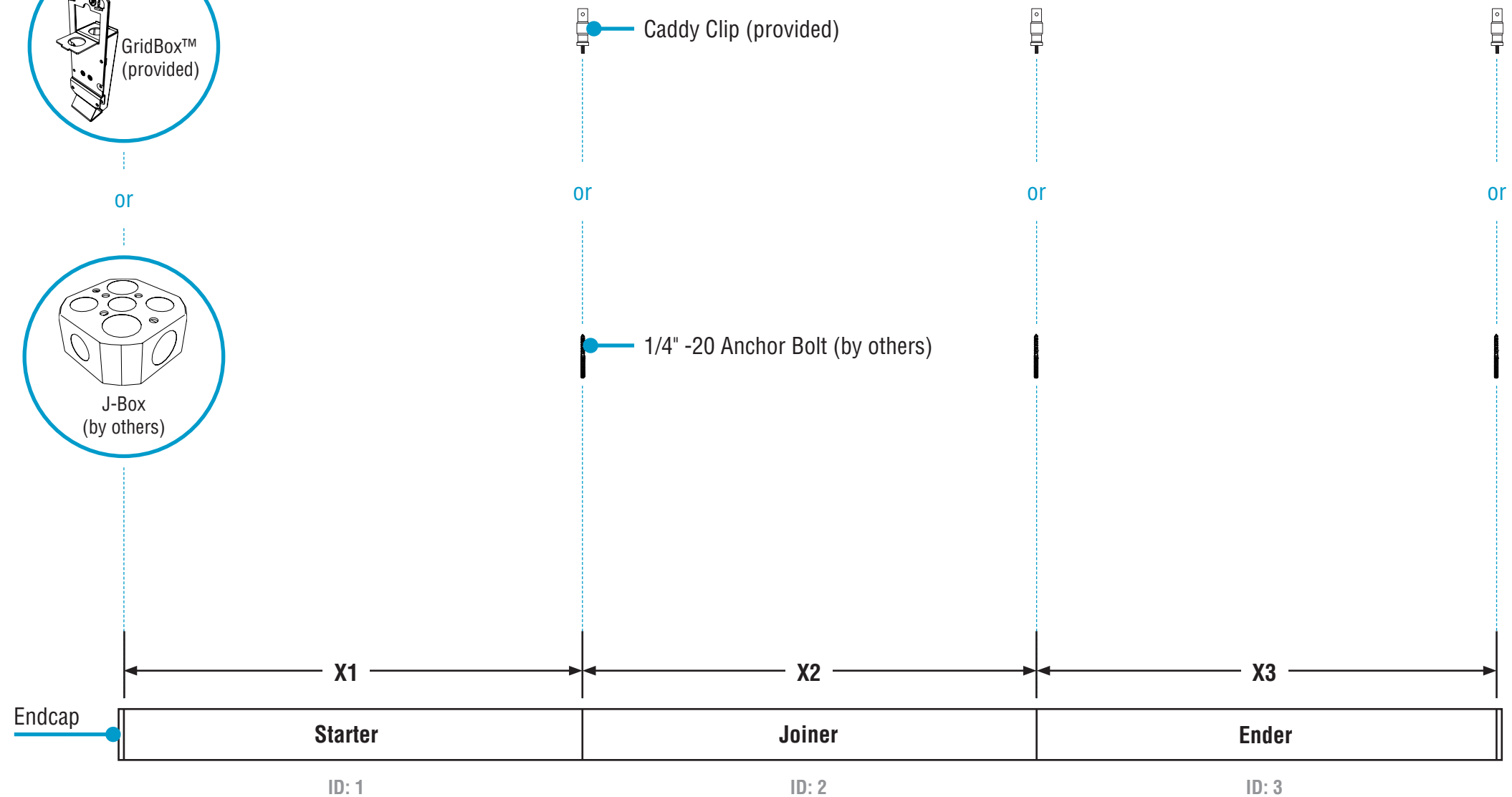

HP-4 Direct Installation Instructions

Step 2 - Identification & Preparation

A. Identify Luminaires



CAUTION

Arrange luminaires in order according to ID# at their install locations.

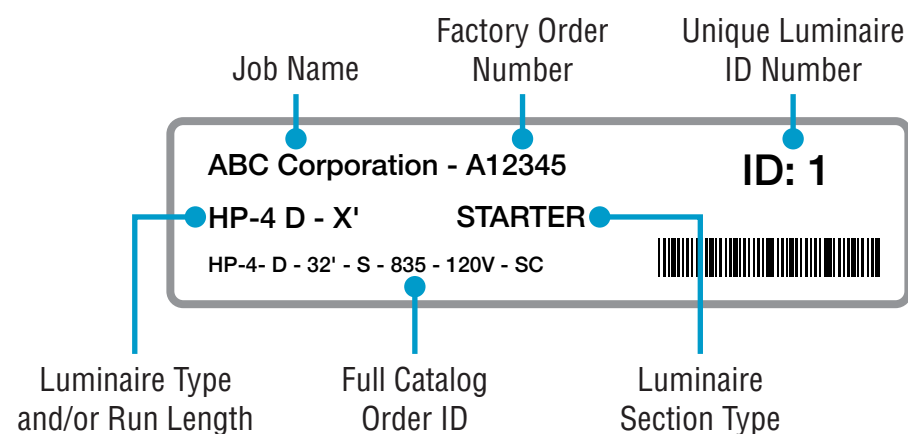

- Identify all luminaires by their ID label that can be found on the box, the diffuser, and inside the luminaire.
- NOTE:** Exact location of labels in these areas may vary.
- Remove all luminaires from their box.
- Refer to Record Drawings that can be found in the hardware kit.

B. Remove Diffusers or Louvers

Remove Diffusers

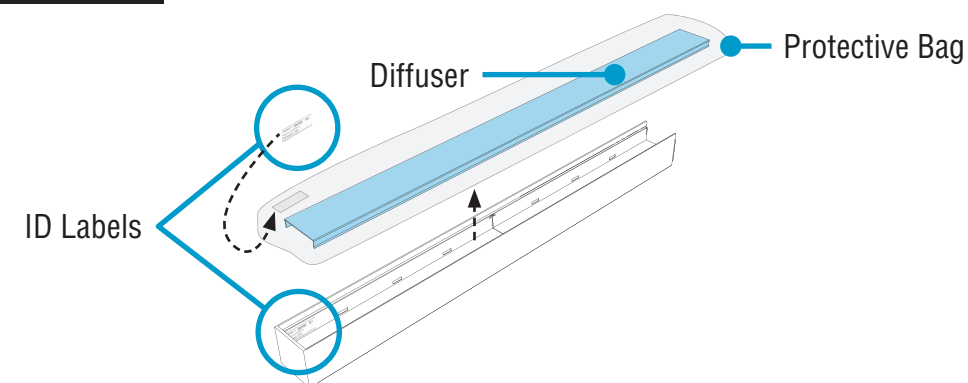

Remove Louvers

NOTE: For White Cross Blade Baffle, refer to Baffle Tether Addendum before installing.

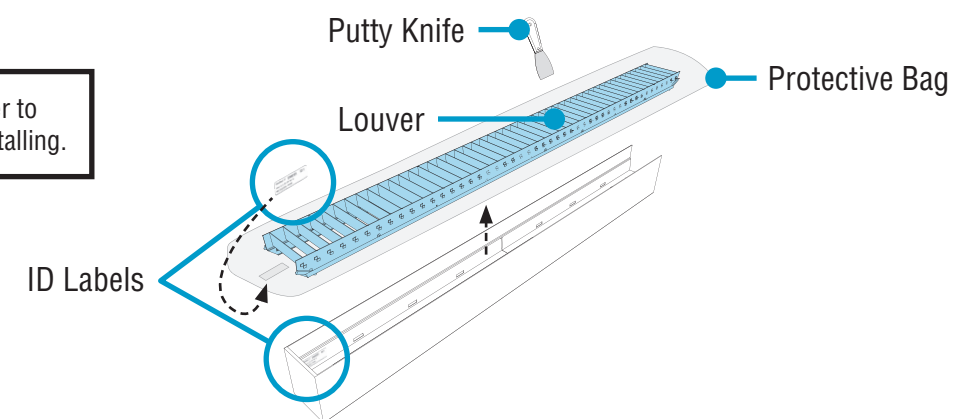



- Carefully remove all diffusers or louvers, keeping them inside their protective bags.
- FOR LOUVERS:** Release louvers by inserting the blade of a putty knife approximately 1" down behind louver edges and pry up.
- Set aside all diffusers or louvers to prevent from getting dirty or damaged.
- Ensure diffusers or louvers can be clearly identified back to their corresponding luminaire.

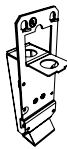

Kitted Hardware

- Finelite has provided items listed here, with their Finelite part numbers. These items can be found in separate boxes shipped with the luminaire.
- Account for all parts and set aside until they are needed.
- All other hardware needed for this installation will be by others.

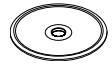
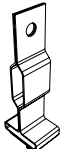
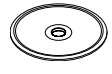
Mounting Option 1

 GridBox™ Part# 89159	 3-1/2" Canopy Part# 89191
 Dual GridBox™ Part# 89199 Mounting & Suspension p. 2, Step 1	 3-1/2" Dual Feed Canopy Part# 89192 Mounting Starter to Structure p. 4, Step 3 Joining Luminaires p. 5, Step 4
 Caddy Clip C1 Ceiling - Part# 94001 C2 Ceiling - Part# 94020 C3 Ceiling - Part# 94029 Mounting & Suspension p. 2, Step 1	 2" T-Bar Support Canopy Part# 89193 Mounting Starter to Structure p. 4, Step 3 Joining Luminaires p. 5, Step 4

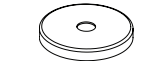
Mounting Option 2

 5" Canopy Part# 94085	 5" Dual Feed Canopy Part# 94145 Mounting Starter to Structure p. 4, Step 3 Joining Luminaires p. 5, Step 4
 2" Drywall Support Canopy Part# 94017 Mounting Starter to Structure p. 4, Step 3 Joining Luminaires p. 5, Step 4	

Cable Bushing
Part# 94014

Aircraft Cable
50" - Part# 94515-12 (Std.)
100" - Part# 94515-14
150" - Part# 94515-18
Mounting Starter to Structure
p. 4, Step 3
Joining Luminaires
p. 5, Step 4

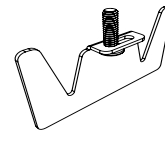
Yoke Bracket
Part# 45042

#10-32 x 5/8" Screw
Part# 94144
Securing Luminaire Joints
p. 7, Step 6

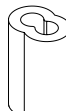
Safety Crimp
Part# 94514
Closing Luminaires
p. 8, Step 7

Slip Ring w/ Set Screw
Part# 94015
Mounting Starter to Structure
p. 4, Step 3
Joining Luminaires
p. 5, Step 4



Louver Removal

HP-4 Direct Installation Instructions

Step 3 - Mounting Starter to Structure

A. Mount Starter to Structure

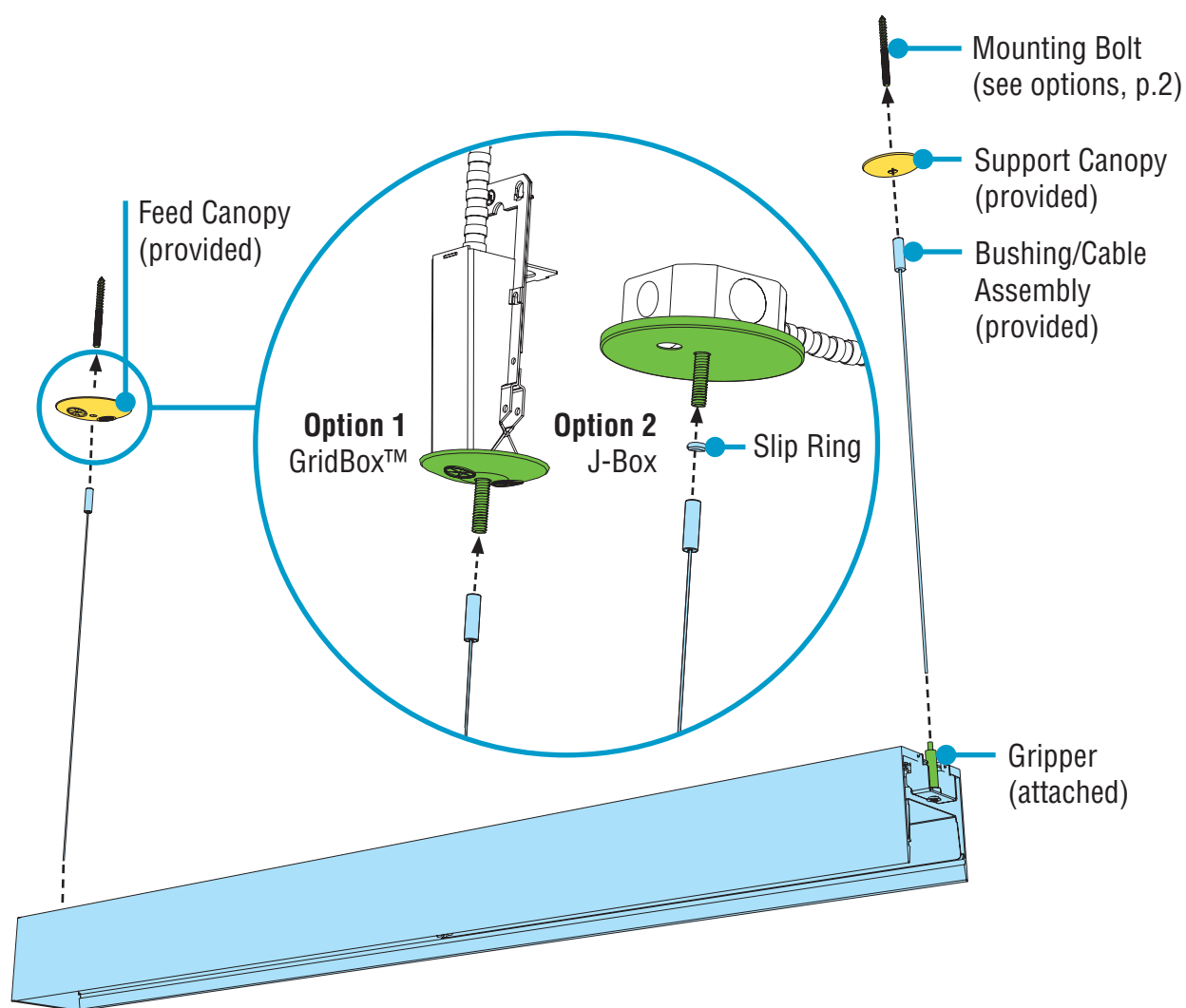

- Slide canopy appropriate for electrical type options onto mounting bolt (anchor bolt or caddy clip bolt).
- **(Option 2 only)** Thread the slip ring onto anchor bolts and secure with set screw at both mounting locations.
- Thread the bushing/cable assembly onto mounting bolts.
- While properly supporting luminaire, maneuver luminaire to ceiling.
- Locate grippers at luminaire ends and feed aircraft cable through it by depressing top of gripper.

B. Make Electrical Connections

WIRING LEGEND		
Black	Hot	Line Voltage
White	Neutral	Line Voltage
Green	Ground	
Grey	Dimming	0-10V DC
Purple	Dimming	0-10V DC

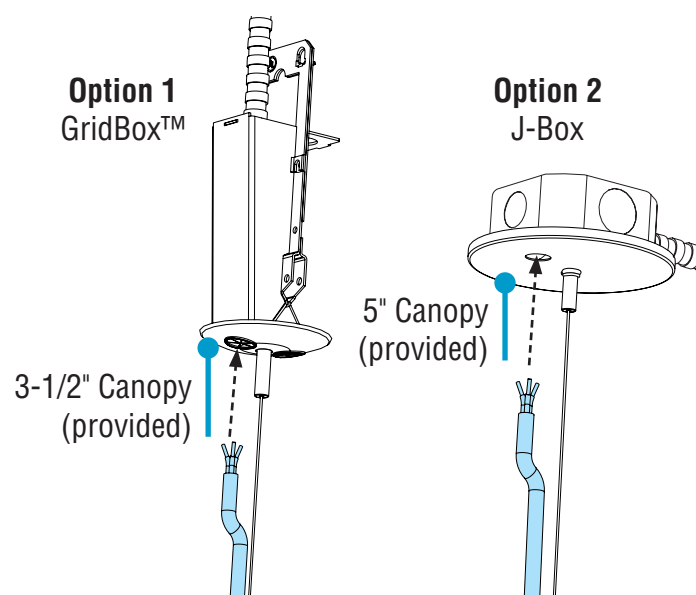

- **(Option 1)** Feed power cord through the 3-1/2" canopy and connect wires inside the GridBox™.
- **(Option 2)** Feed power cord through the 5" canopy and connect wires inside the J-Box.
- **CRITICAL:** If installing an independent luminaire, perform all leveling. **PROCEED TO STEP 7.**

OPTIONAL Flexible Mount pendant brackets are adjustable for custom mounting locations.

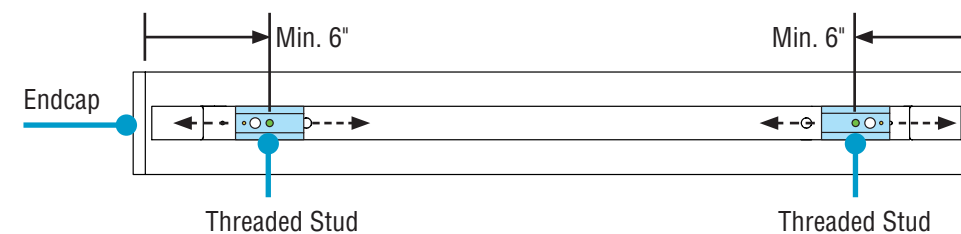

- **NOTE:** Minimum 6" from end of housing to threaded stud on pendant bracket.
- Maximum distance depends on length of luminaire (see table).

Luminaire Length	Max.
4' - 12'	24"
3' and less	12"

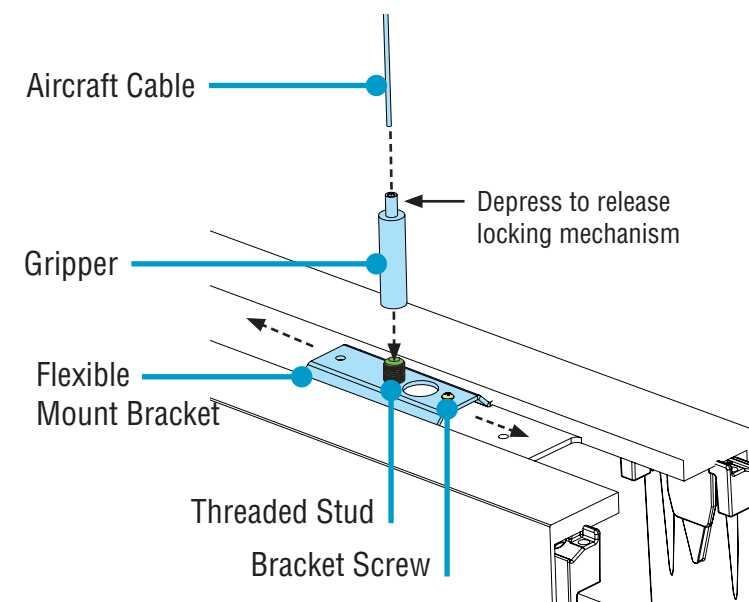

- Loosen **(but do not remove)** the bracket screw.
- Slide flexible mount pendant bracket to desired location and tighten screw to secure.
- Attach gripper onto threaded stud.
- Feed bushing/cable assembly through gripper by depressing top of gripper.
- Allow excess cable to rest atop luminaire. Crimp then trim, if necessary.

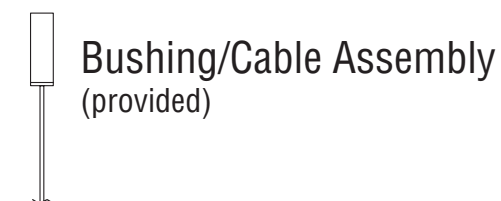
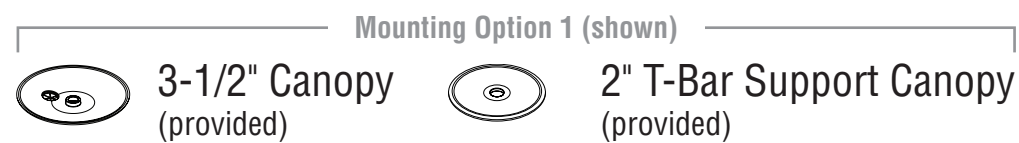

0-10V Dimming

HP-4 Direct Installation Instructions

Step 4 - Joining Luminaires

A. Mount Joiner/Ender to Structure



CAUTION

DO NOT attempt to join luminaires together on the floor. Damage may result when lifted. Follow these instructions.

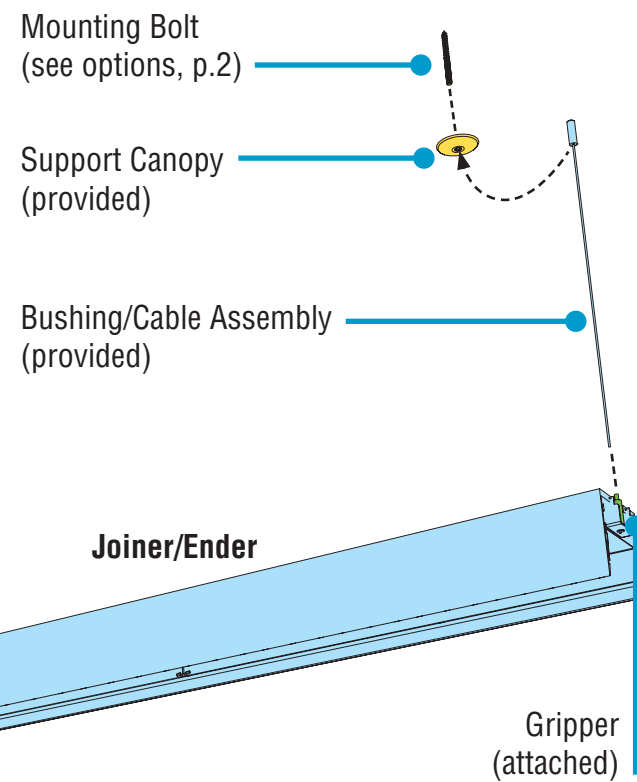

- For the joiner/ender luminaire, slide canopy appropriate for electrical type onto mounting bolt (anchor bolt or caddy clip bolt).
- Thread the bushing/cable assembly onto mounting bolt.
- While properly supporting luminaire, maneuver luminaire to ceiling.
- Locate gripper at luminaire ends and feed aircraft cable through it by depressing top of gripper.

B. Join Luminaires



CAUTION

Once luminaires are aligned together, **joiner luminaire is not yet secure.** Ensure it does not slide off as it rests on the starter luminaire.

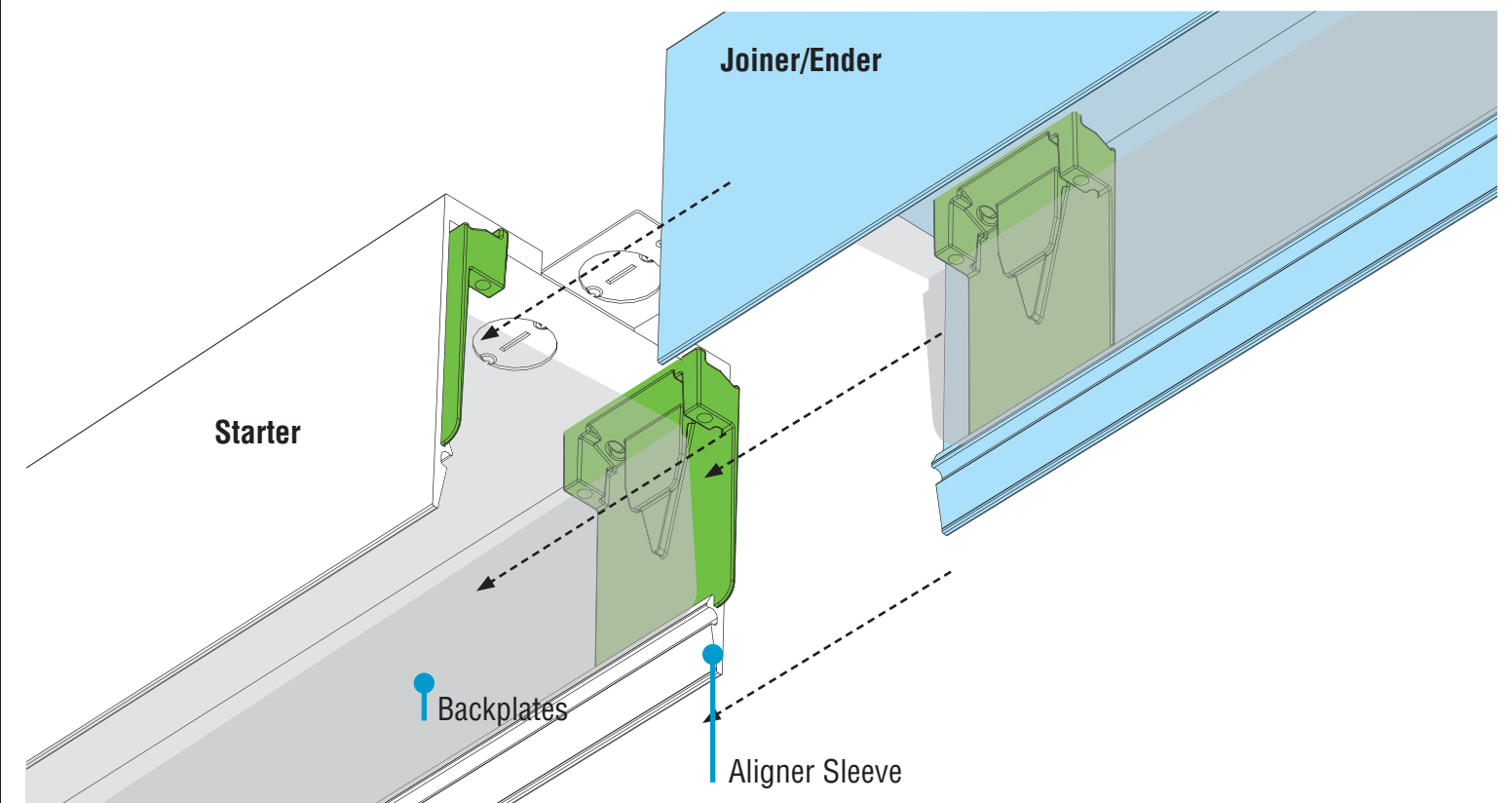

- Align joiner/ender with aligner sleeves on starter and slide together. Be careful not to damage any wiring.
- If necessary, **lift** both luminaires, then slide together.

Mounting Option 1 (shown)

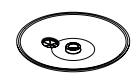

3-1/2" Canopy (provided)

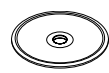

2" T-Bar Support Canopy (provided)

Mounting Option 2

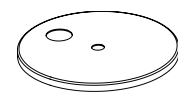

5" Canopy (provided)

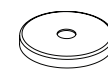

2" Drywall Support Canopy (provided)



Slip Ring w/ Set Screw (provided)



Bushing/Cable Assembly (provided)

HP-4 Direct Installation Instructions

Step 5 - Opening Luminaires

Release Backplates

Putty Knife Option

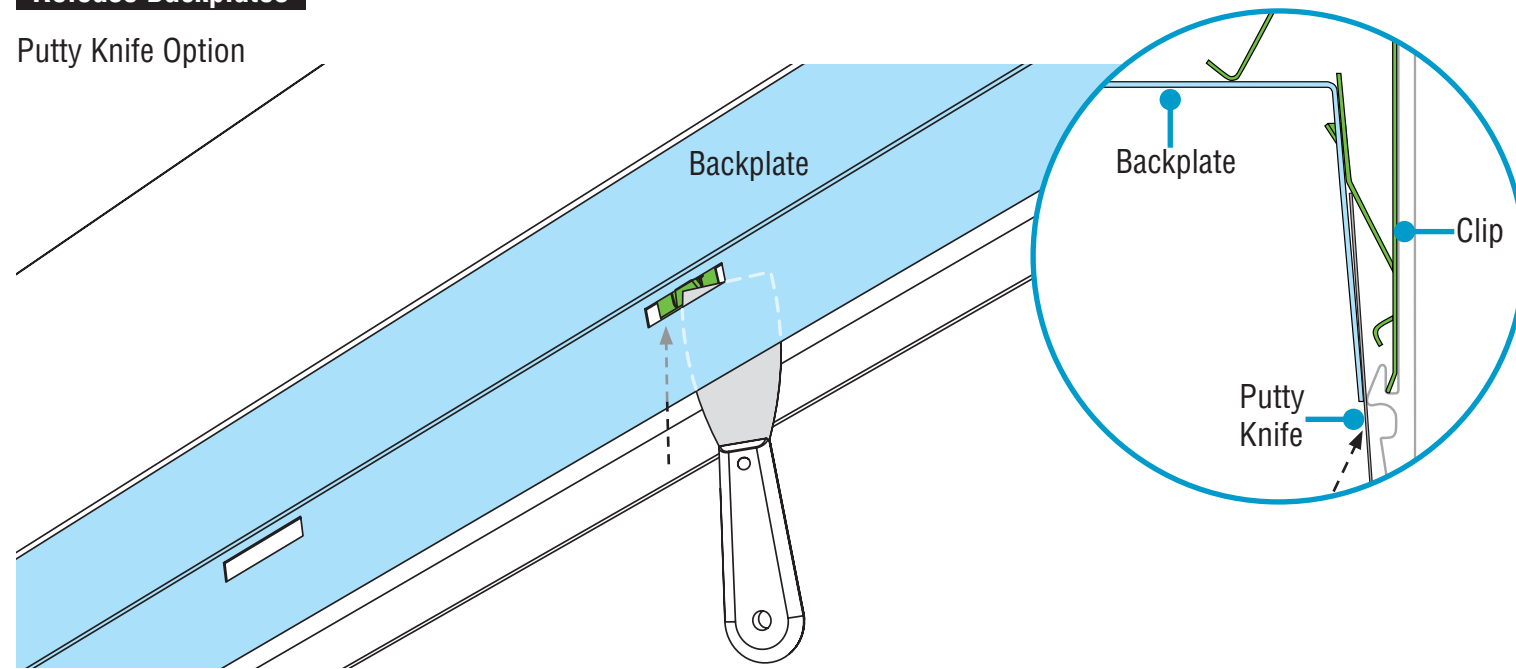

Flathead Screwdriver Option

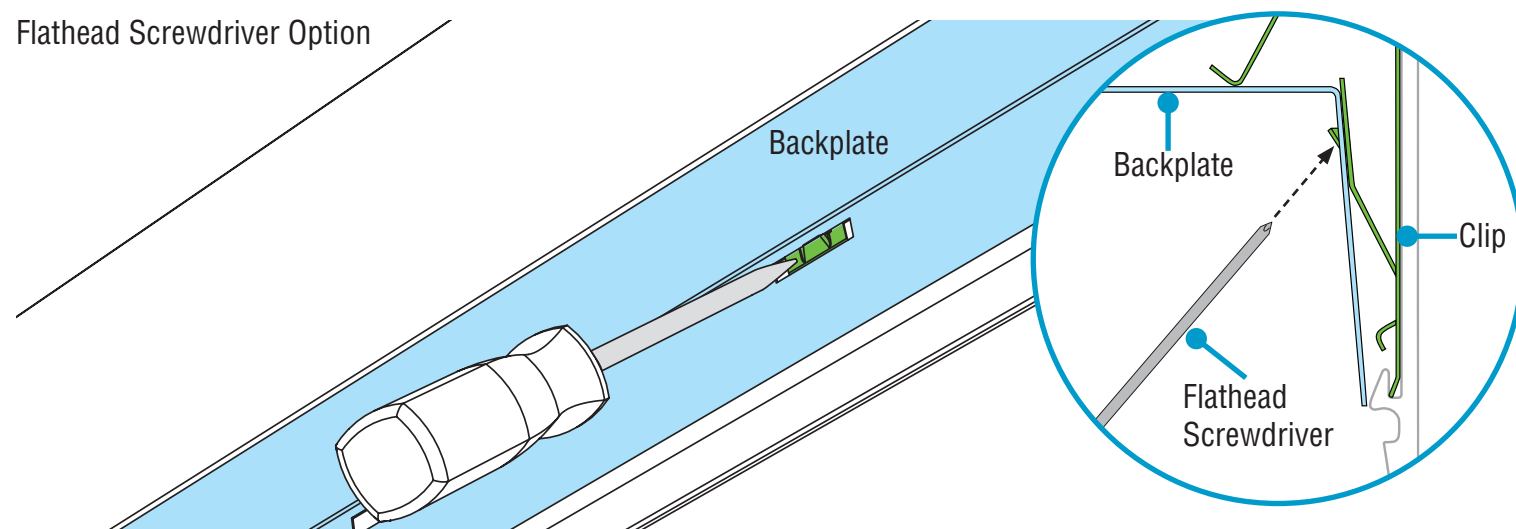

- **NOTE:** For independent luminaires, backplates do not need to be released.
- Release the backplates from clips by sliding the blade of a putty knife behind backplate edges.
- To use a flathead screwdriver, press end of screwdriver (from inside the luminaire) against the clip, until the backplate is released.

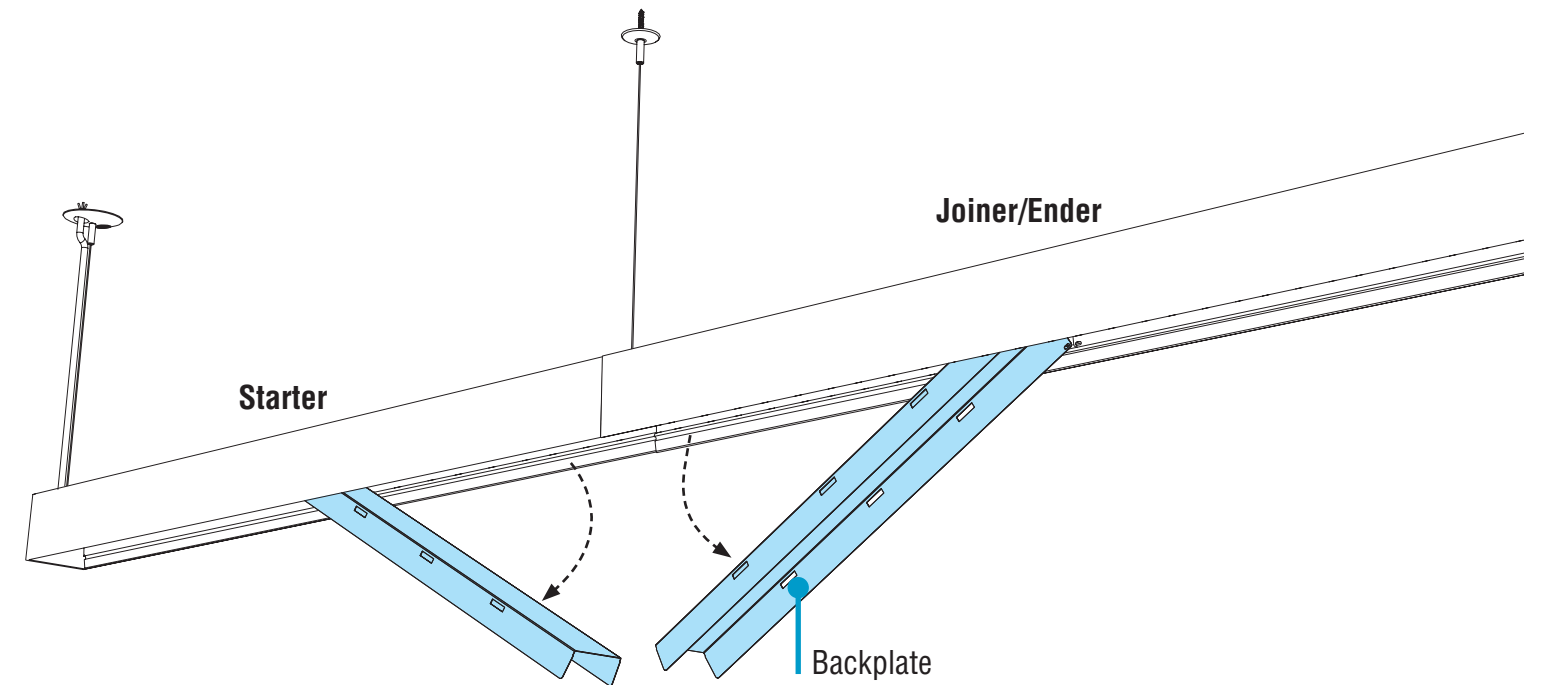

- Carefully rotate backplates out **at the joints only** and let them hang from luminaire body.



Effortless
Access

HP-4 Direct Installation Instructions

Step 6 - Securing Luminaire Joints

A. Secure Joint with Yoke Brackets

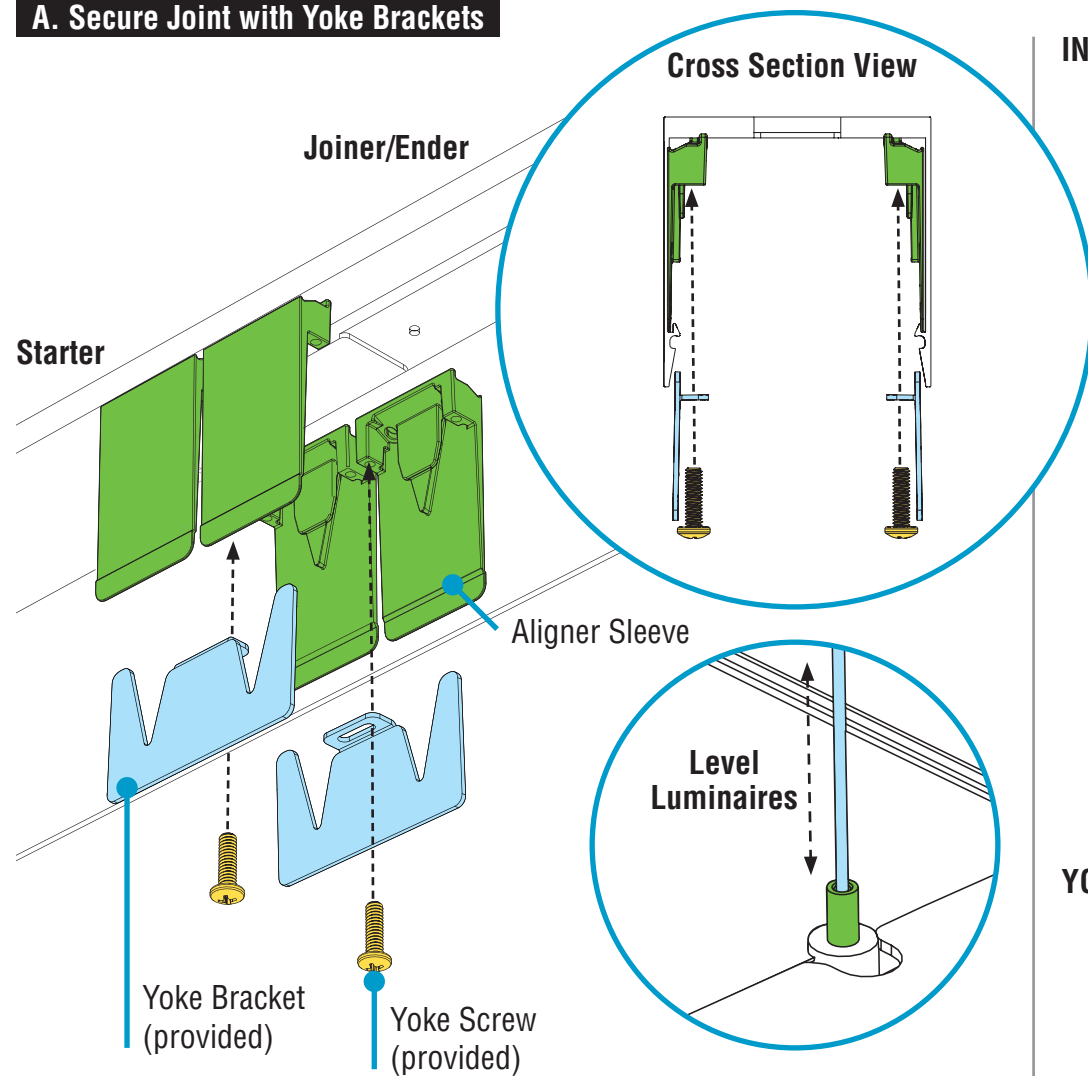

- **FOR SENSOR OR SOCKET:** If luminaire contains a sensor or socket at joint, refer to page 4 of appropriate Addendum before Securing Luminaire Joints.
- Before installing yoke brackets, ensure the joining ends of luminaires meet flush and square.
- **CRITICAL:** Ensure yoke brackets properly engage with aligner sleeves.
- Secure joint by threading (but not yet tightening) yoke screws through yoke brackets and into the aligner sleeves.
- Level all luminaires to desired height by depressing top of grippers to adjust cable lengths.
- Tighten yoke screws¹ until joint seam of luminaires is closed.

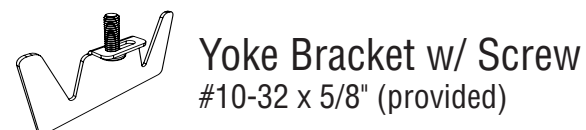

¹ Screwdriver with 6" bit required.

IN ALIGNMENT

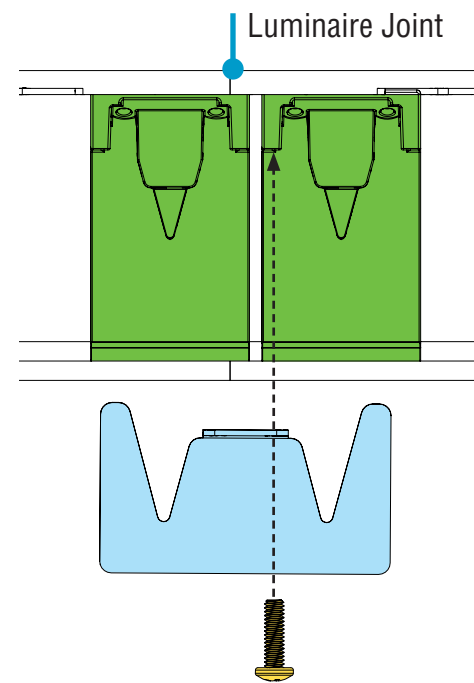

YOKE SCREW ALIGNMENT Bottom-Up View

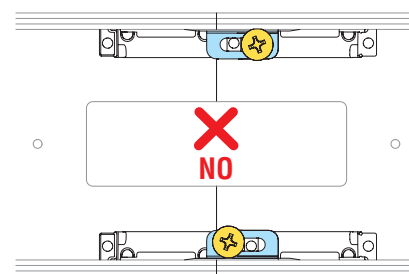

NOTE: Yoke screws should be installed directly across from each other, not diagonally, and in holes furthest from the joint line. One yoke screw per one yoke bracket.

CORRECTLY INSTALLED

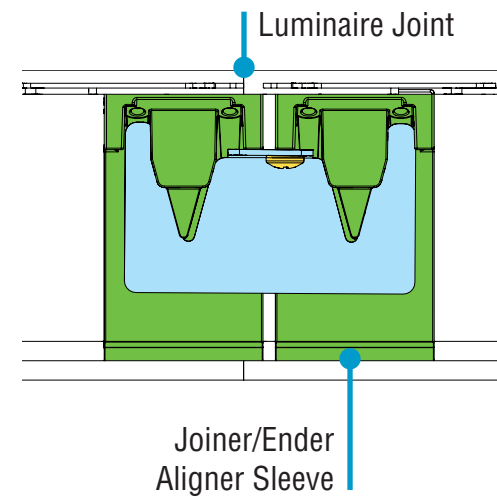

Luminaire Joint Joiner/Ender Aligner Sleeve

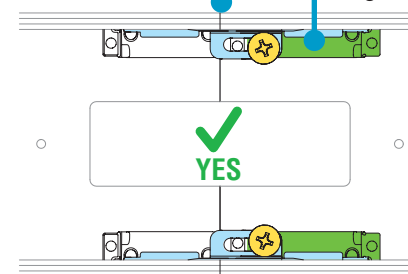

B. Make Electrical Connections

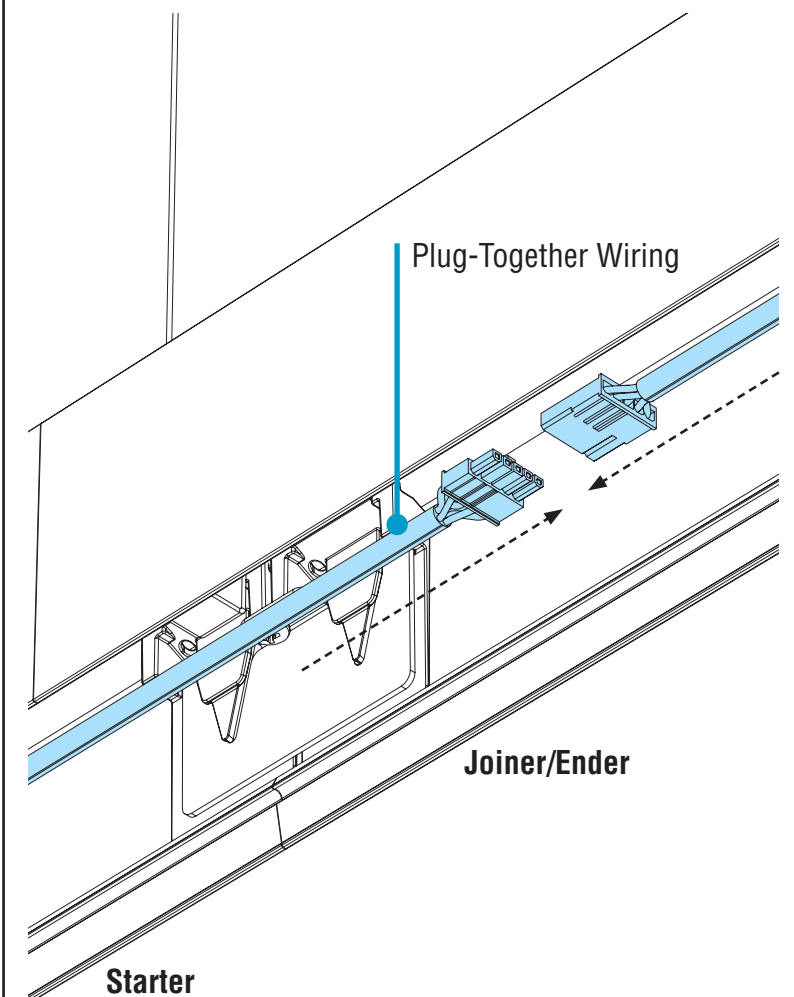

- Connect plug-together wiring.



Socket Removal
& Installation



Universal &
Robust Joints



Simple
Plug-Together
Wiring

HP-4 Direct Installation Instructions

Step 7 - Closing Luminaires

A. Crimp Cables

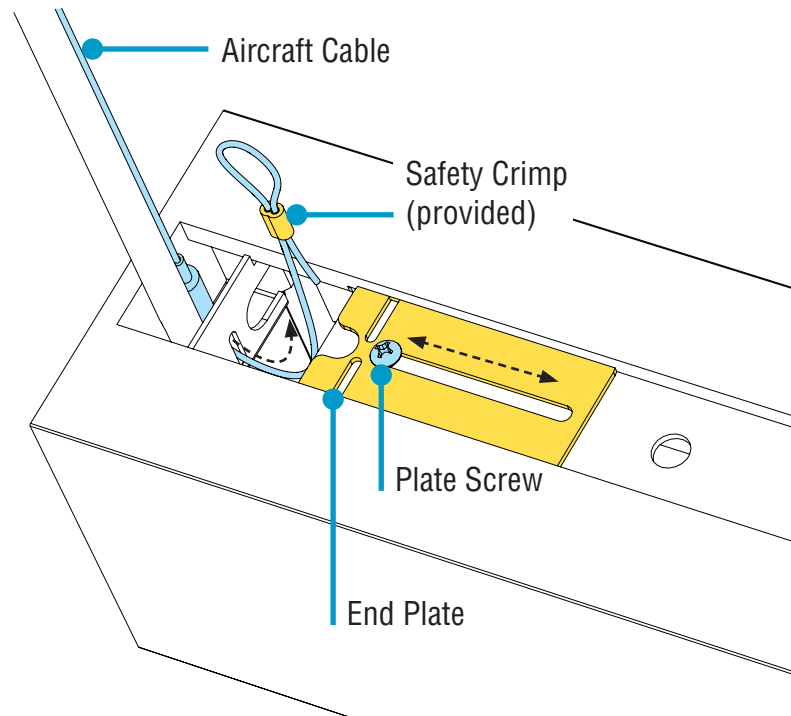

- Ensure all leveling has been performed prior to applying safety crimp.
- Loosen (**but do not remove**) plate screw and slide end plate open.
- Loop aircraft cable through safety crimp.
- Crimp, cut excess cable, and tuck back into luminaire body.
- Close end plate and tighten plate screw to secure. Typical for each aircraft cable.



B. Final Step - Replace Backplates & Diffusers or Louvers

NOTE: For White Cross Blade Baffle, refer to Baffle Tether Addendum before installing.

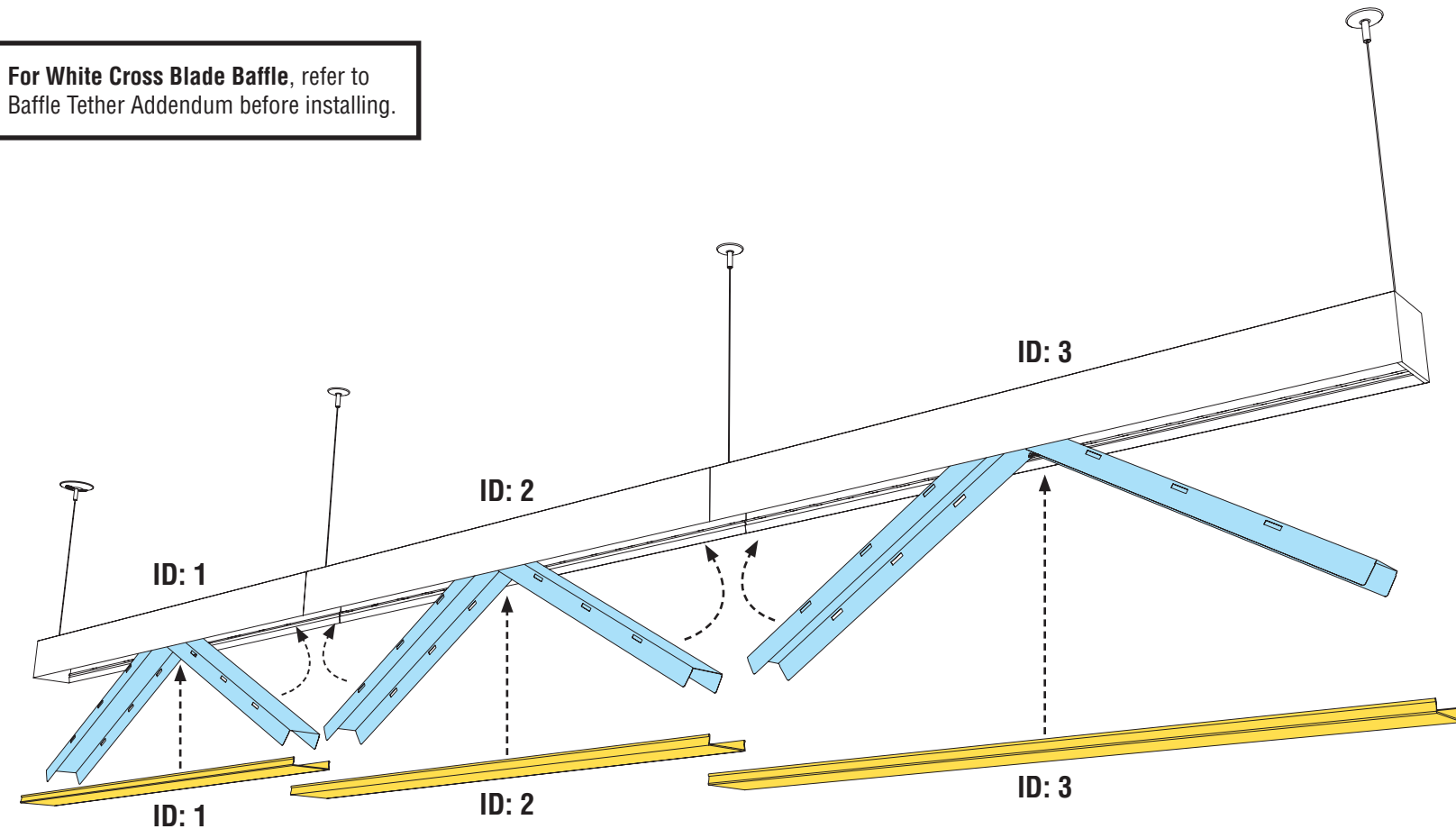

- **NOTE:** If your installation includes a battery backup, please see addendum (98333) that should be included with your kitting package.
- **FOR SENSOR OR SOCKET:** If luminaire contains a sensor or socket at joint, refer to page 5 of appropriate Addendum before Closing Luminaires.
- Reinstall any open backplates by rotating into luminaire body and snapping back into clips.
- Remove diffusers or louvers from protective plastic bags.
- **CAUTION:** Wear gloves to keep diffuser or louver surface clean.
- **CRITICAL:** Be sure to install correct diffuser or louver to its corresponding luminaire ID.
- **NOTE:** For White Cross Blade Baffle, refer to Baffle Tether Addendum before installing.
- Install diffuser or louver into luminaire body, ensuring it snaps into place.
- Turn power on to luminaires.



Socket Removal
& Installation