

HP-2 / HP-4 / HP-6 Recessed T-Bar Installation Instructions

Regressed Luminaires Use Same Instructions

Overview

NOTES

- If luminaire contains a sensor or socket refer to the appropriate Addendum.
- All power connections should be installed according to local/national codes by a Certified Electrician.
- This installation requires **proper support** as each luminaire is being installed.
- **DO NOT attempt to join luminaires together on the floor.** Damage may result when lifted.



HELPFUL
VIDEOS



Louver
Removal



0-10V
Dimming



Effortless
Access



Socket Removal
& Installation



Universal &
Robust Joints



Simple
Plug-Together
Wiring

Step 1
T-Bar Dimensions &
Mounting Types
Pages 2-3

Step 2
Identification & Preparation
Page 4

Step 3
Mounting Starter to Structure
Page 5

Step 4
Joining Luminaires
Page 6

Step 5
Opening Luminaires
Page 7

Step 6
Securing Luminaire Joints
Page 8

Step 7
Closing Luminaires
Page 9

HP-2 / HP-4 / HP-6 Recessed T-Bar Installation Instructions

Step 1 - T-Bar Dimensions & Mounting Types

Total Run Length

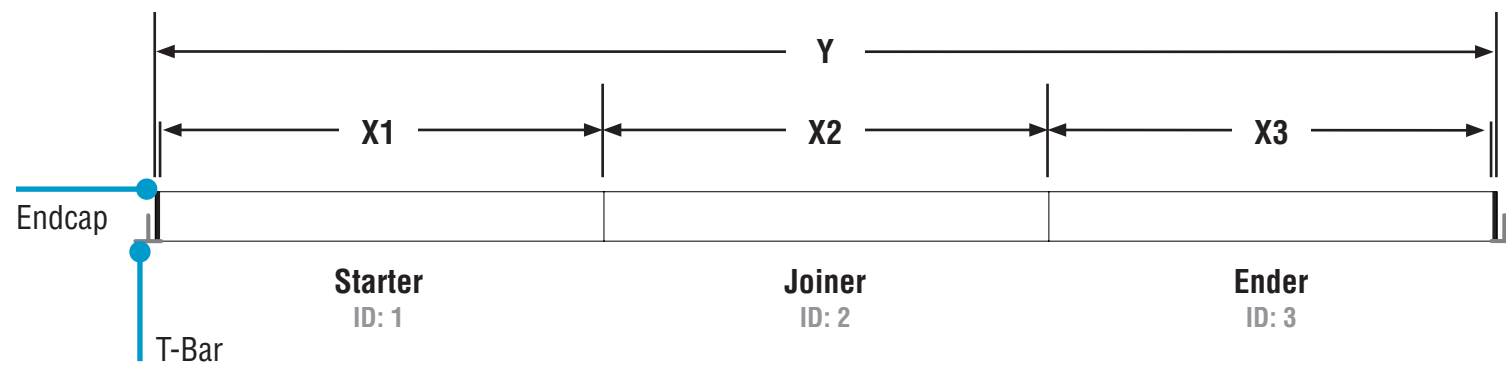

X = Luminaire section length (**Does not include** endcaps)
Y = Total run length of luminaire (**Includes** 1/8" for **BOTH** endcaps)
Endcap = 1/16"

Refer to Record Drawings and building plans to determine exact mounting, suspension points, and power feed locations.

T-Bar Build Dimensions

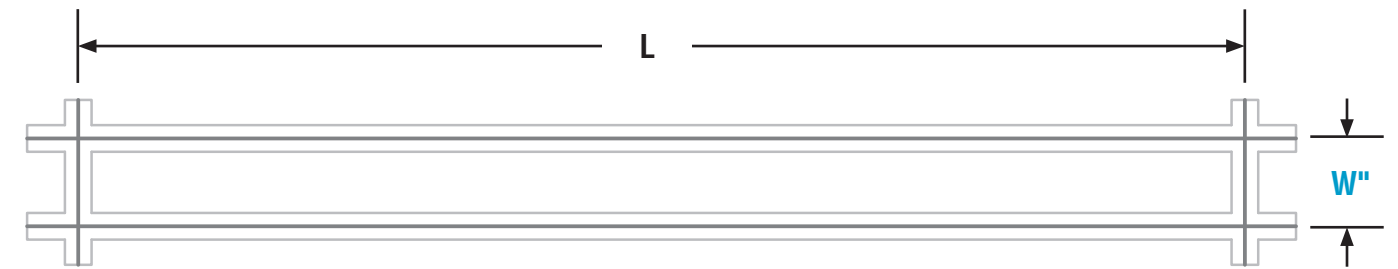

	L = Total Run T-Bar Length
HP-2, HP-4, & HP-6	Y + 1"
HP-4 C1T (only)	Y + 1"

W = T-Bar Width

Center to center of T-Bar. Tolerance: +/- 1/16"

Construct T-Bar ceiling for luminaire placement based on length and width dimensions per diagram.

HP-2 / HP-4 / HP-6 Recessed T-Bar Installation Instructions

Step 1 - T-Bar Dimensions & Mounting Types

Mounting Types & T-Bar Width

RECESSED - HP-2, HP-4, HP-6

1" T-Bar (C1)

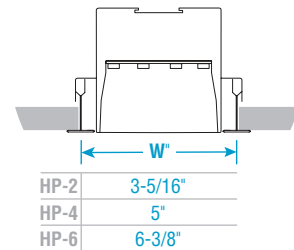

9/16" T-Bar (C2)

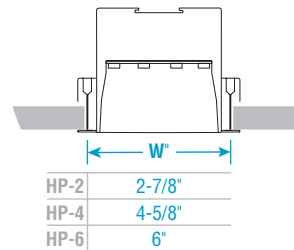

1" T-Bar Tegular (C1T)

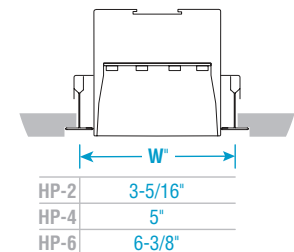

9/16" T-Bar Tegular (C2T)

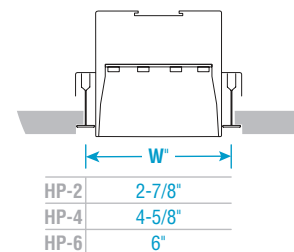

Standard Screw Slot (C3)

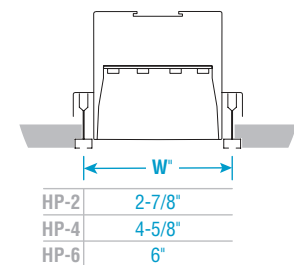

Flush Screw Slot (C3F)

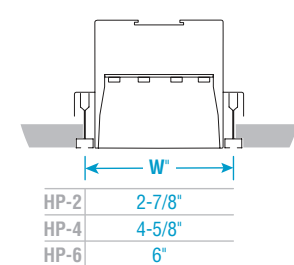

Tech Zone (TZ4)

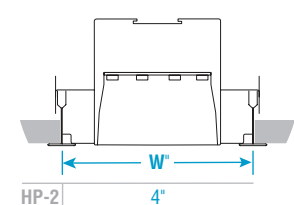

Tech Zone (TZ6)

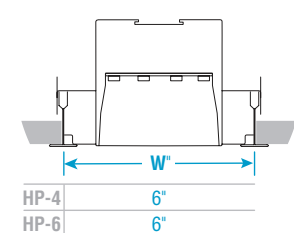

REGRESSED - HP-2 & HP-4

1" T-Bar (C1)

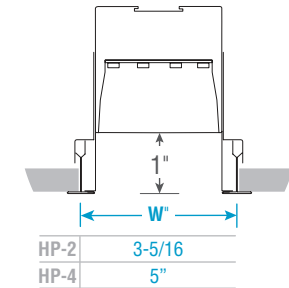

9/16" T-Bar (C2)

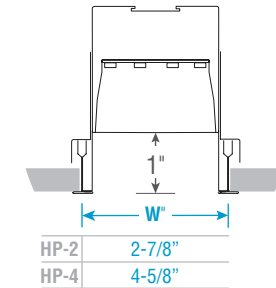

1" T-Bar Tegular (C1T)

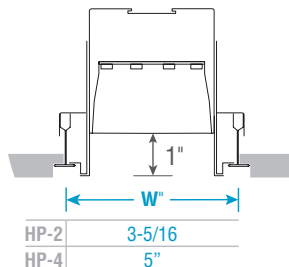

9/16" T-Bar Tegular (C2T)

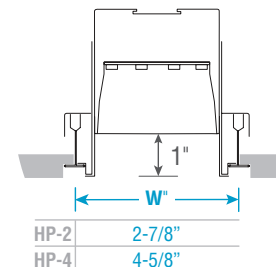

Standard Screw Slot (C3)

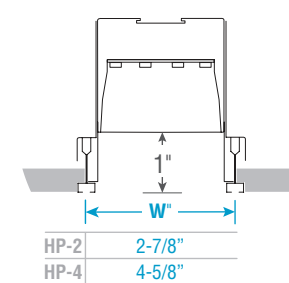

Flush Screw Slot (C3F)

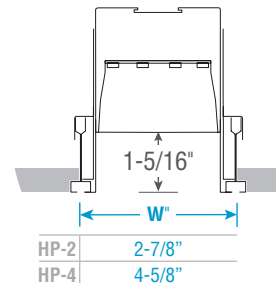

Tech Zone (TZ4)

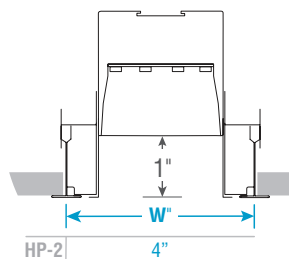

Tech Zone (TZ6)

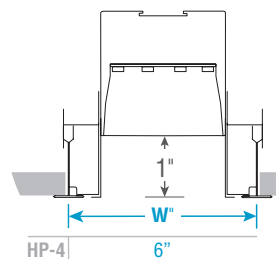

AIR RETURN - HP-6 ONLY

1" T-Bar (C1)

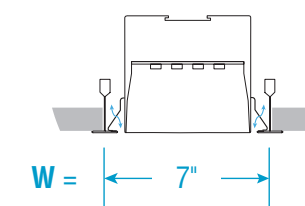

9/16" T-Bar (C2)

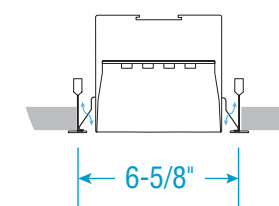

1" T-Bar Tegular (C1T)

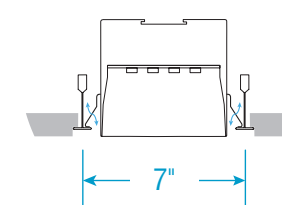

9/16" T-Bar Tegular (C2T)

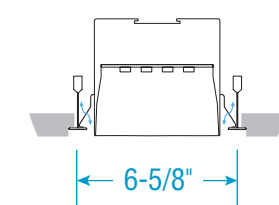

Standard Screw Slot (C3)

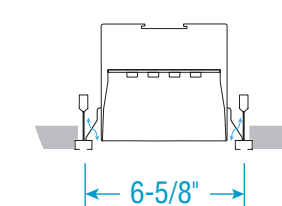

Flush Screw Slot (C3F)

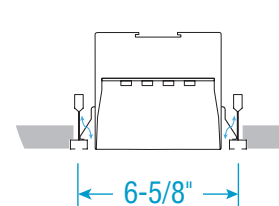

- **NOTE:** Only for standard 2x4 or 2x2 T-Bar ceiling, the starter luminaire is purposefully short by 1-1/8" to ensure fit in T-Bar types, shown above.
- The luminaire endcaps and end flanges cover any gaps to ensure smooth flush appearance at the ends.

W = T-Bar Width

HP-2 / HP-4 / HP-6 Recessed T-Bar Installation Instructions

Step 2 - Identification & Preparation

A. Identify Luminaires



CAUTION

Arrange luminaires in order according to ID# at their install locations.

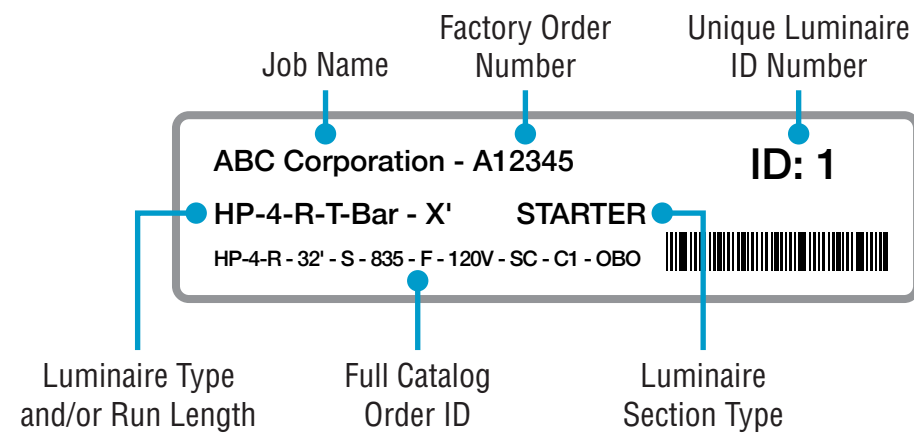

- Identify all luminaires by their ID label that can be found on the box, the diffuser, and inside the luminaire.
- NOTE:** Exact location of labels in these areas may vary.
- Remove all luminaires from their box.
- Refer to Record Drawings that can be found in the hardware kit.

B. Remove Diffusers or Louvers

Remove Diffusers

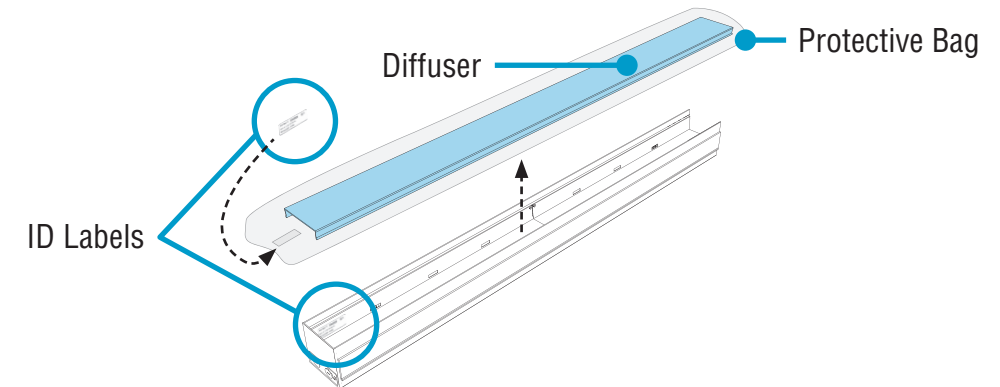

Remove Louvers (HP-2 & HP-4 ONLY)

NOTE: For White Cross Blade Baffle, refer to Baffle Tether Addendum before installing.

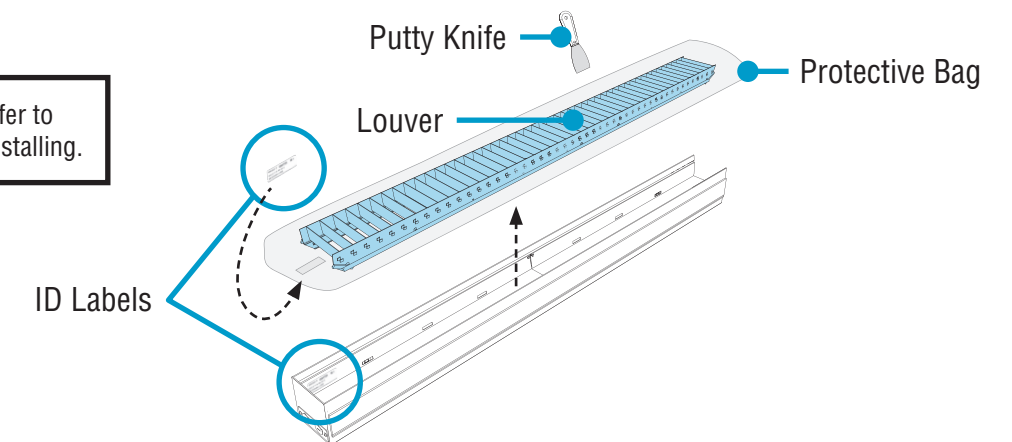

- Carefully remove all diffusers or louvers, keeping them inside their protective bags.
- FOR LOUVERS:** Release louvers by inserting the blade of a putty knife approximately 1" down behind louver edges and pry up.
- Set aside all diffusers or louvers to prevent from getting dirty or damaged.
- Ensure diffusers or louvers can be clearly identified back to their corresponding luminaire.

Kitted Hardware

- Finelite has provided items listed here, with their Finelite part numbers. These items can be found in separate boxes shipped with the luminaire.
- Account for all parts and set aside until they are needed.
- All other hardware needed for this installation will be by others.

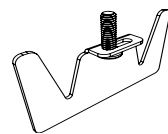

Yoke Bracket
Part# 45042

#10-32 x 5/8" Screw
Part# 94144
Securing Luminaire Joints
p. 8, Step 6

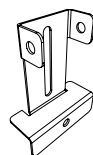

T-Bar Bracket (C1, C2, C3)
Part# 45651

T-Bar Bracket (TZ4)
Part# 20510

T-Bar Bracket (C1T, C2T, C3F)
Part# 27038

T-Bar Bracket (TZ6)
Part# 27040
Closing Luminaires
p. 9, Step 7



#8 Self-Drilling Screw
Part# 94138
Closing Luminaires
p. 9, Step 7



#6 Self-Drilling Screw
Part# 94054
Closing Luminaires
p. 9, Step 7



Louver Removal

HP-2 / HP-4 / HP-6 Recessed T-Bar Installation Instructions

Step 3 - Mounting Starter to Structure

A. Mount Starter to Structure

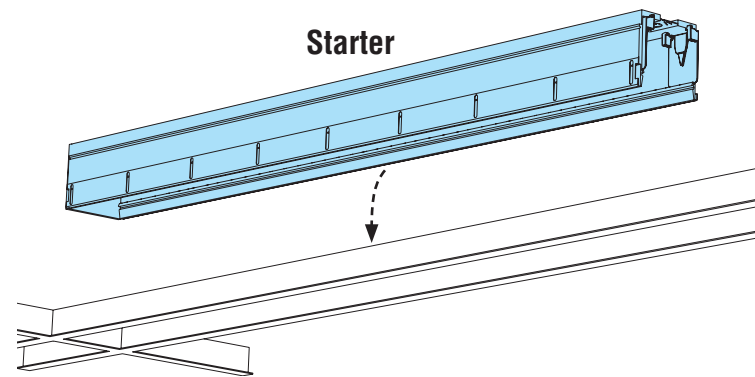

- Maneuver luminaire into ceiling space above T-Bar ceiling.
- Lower luminaire into place onto T-Bar.
- Make electrical connections at **ENDCAP**, at **TOP** or with a **SPLICE BOX**.
- If there is no joiner/ender, then tighten nuts fully. **PROCEED TO STEP 7, B.**

B. Make Electrical Connections

WIRING LEGEND

Black	Hot	Line Voltage
White	Neutral	Line Voltage
Green	Ground	
Pink	Dimming	0-10V DC
Purple	Dimming	0-10V DC

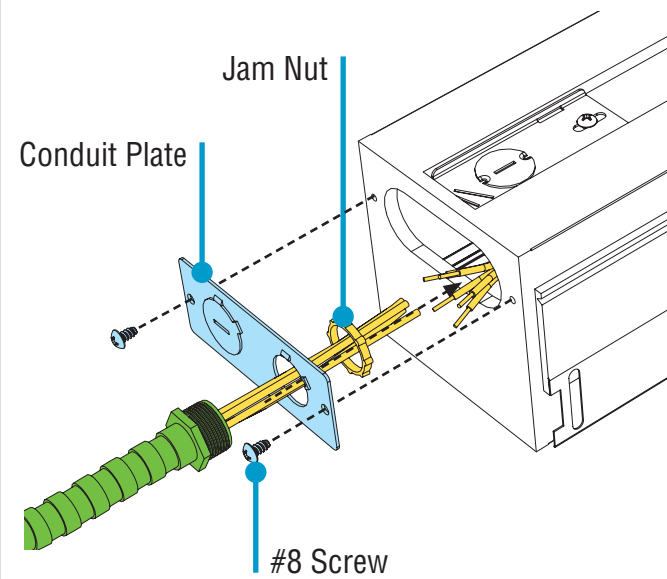

CONDUIT PLATE - ENDCAP (Standard)

- Remove two screws holding conduit plate.
- Install conduit and jam nut onto conduit plate.
- Wire-nut electrical connections. See wiring legend above.
- Reinstall conduit plate and screws. Do not damage any wires.

HP-4 Only

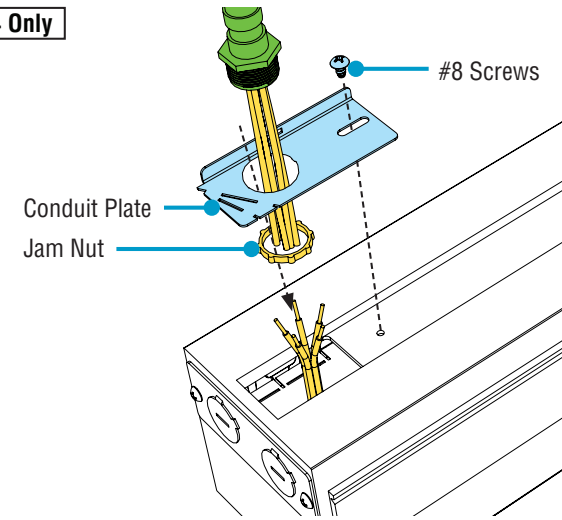

CONDUIT PLATE - TOP (Optional: HP-4 ONLY)

- Remove screw holding conduit plate.
- Install conduit and nut onto conduit plate.
- Wire-nut electrical connections. See wiring legend above.
- Reinstall conduit plate and screw. Do not damage any wires.

HP-2 & HP-6 Only

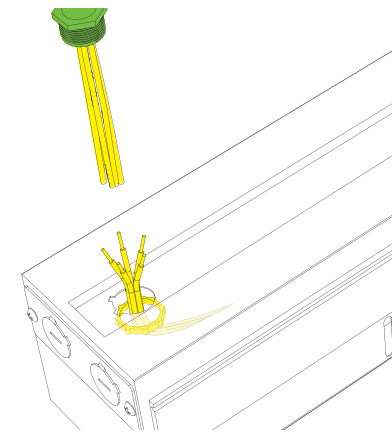

CONDUIT KO - TOP (Optional: HP-2, HP-6 ONLY)

- Install conduit and nut onto KO.
- Wire-nut electrical connections. See wiring legend above.

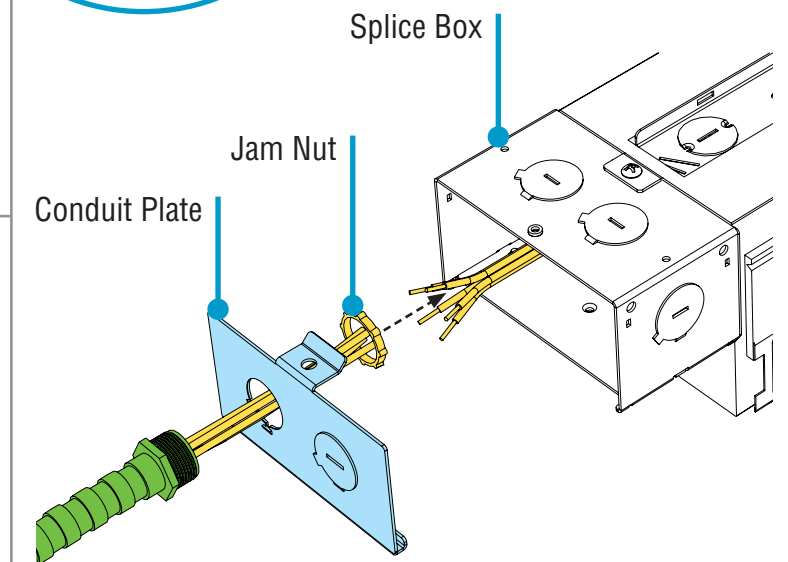
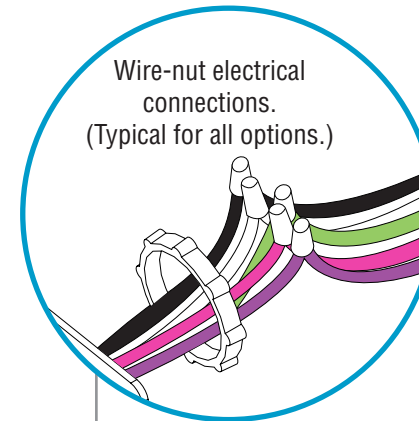

SPLICE BOX (Optional)

- Lift tab to unsnap and remove splice box cover.
- Install conduit and nut onto splice box cover.
- Wire-nut electrical connections. See wiring legend above.
- Reinstall splice box cover. Do not damage any wires.

 Flex Conduit
(by others)



0-10V
Dimming

HP-2 / HP-4 / HP-6 Recessed T-Bar Installation Instructions

Step 4 - Joining Luminaires

A. Mount Joiner/Ender to Structure



CAUTION

DO NOT attempt to join luminaires together on the floor. Damage may result when lifted. Follow these instructions.

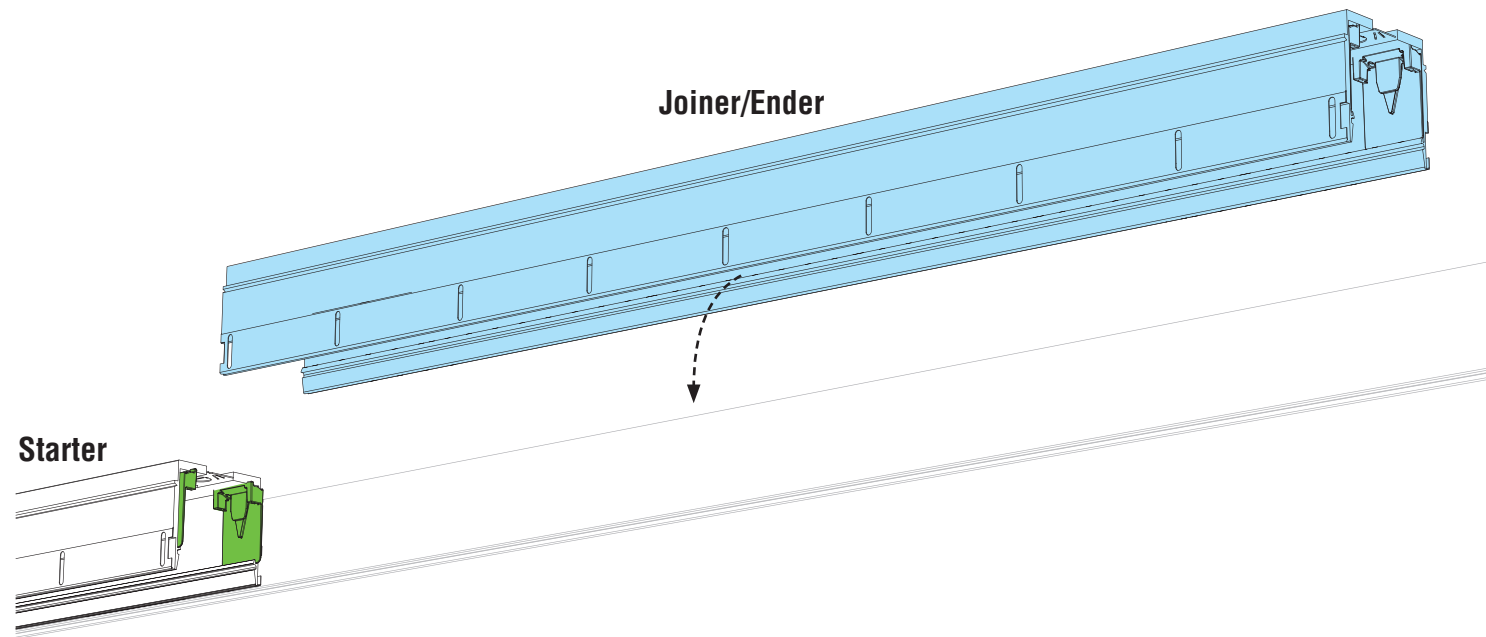

- Maneuver joiner/ender into ceiling and position onto T-bar.

B. Join Luminaires



CAUTION

Once luminaires are aligned together, **joiner luminaire is not yet secure**. Ensure it does not slide off as it rests on the starter luminaire.

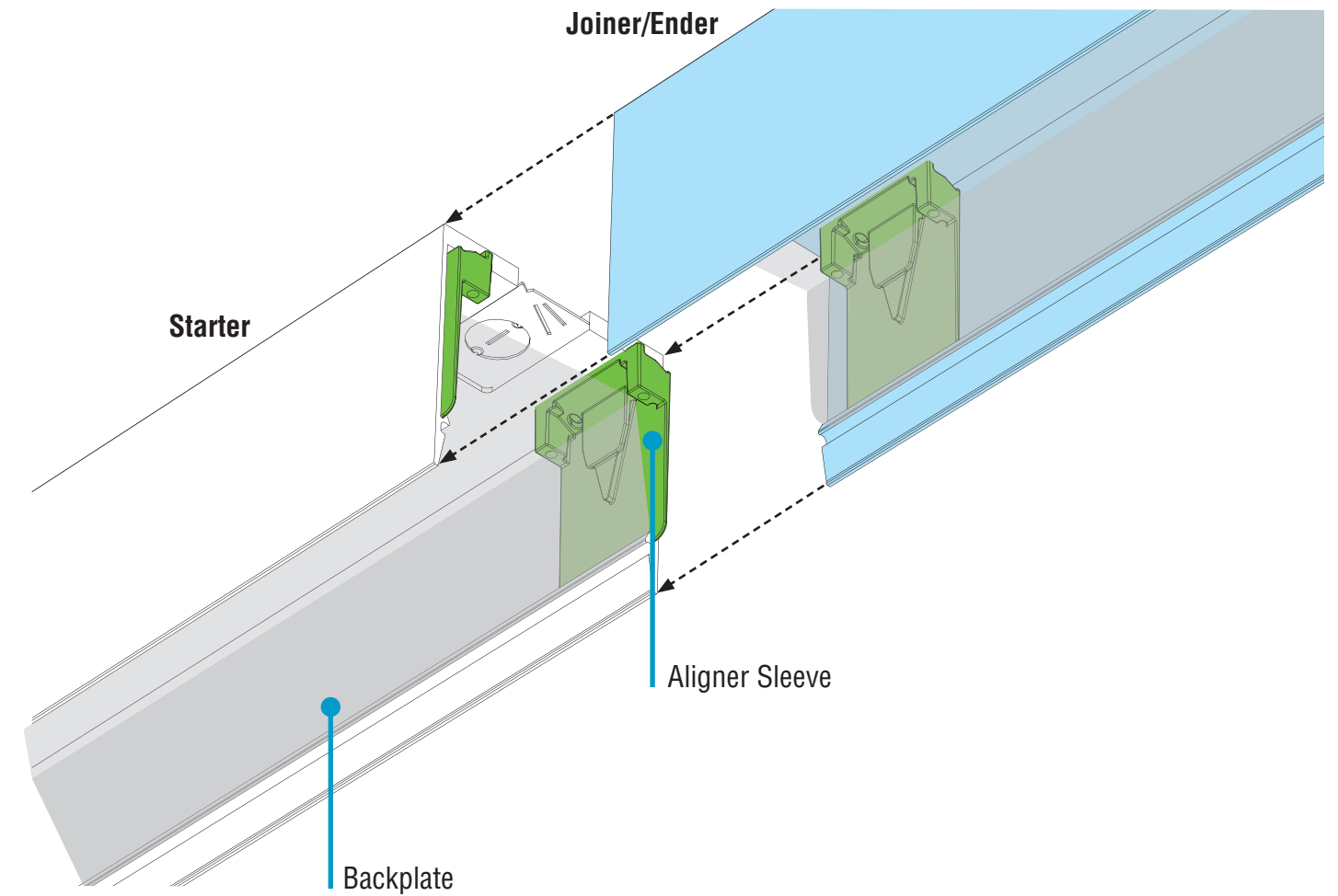

- Align joiner/ender with aligner sleeves on starter and slide together. Be careful not to damage any wiring.
- If necessary, **lift** both luminaires, then slide together.

HP-2 / HP-4 / HP-6 Recessed T-Bar Installation Instructions

Step 5 - Opening Luminaires

Release Backplates

Putty Knife Option

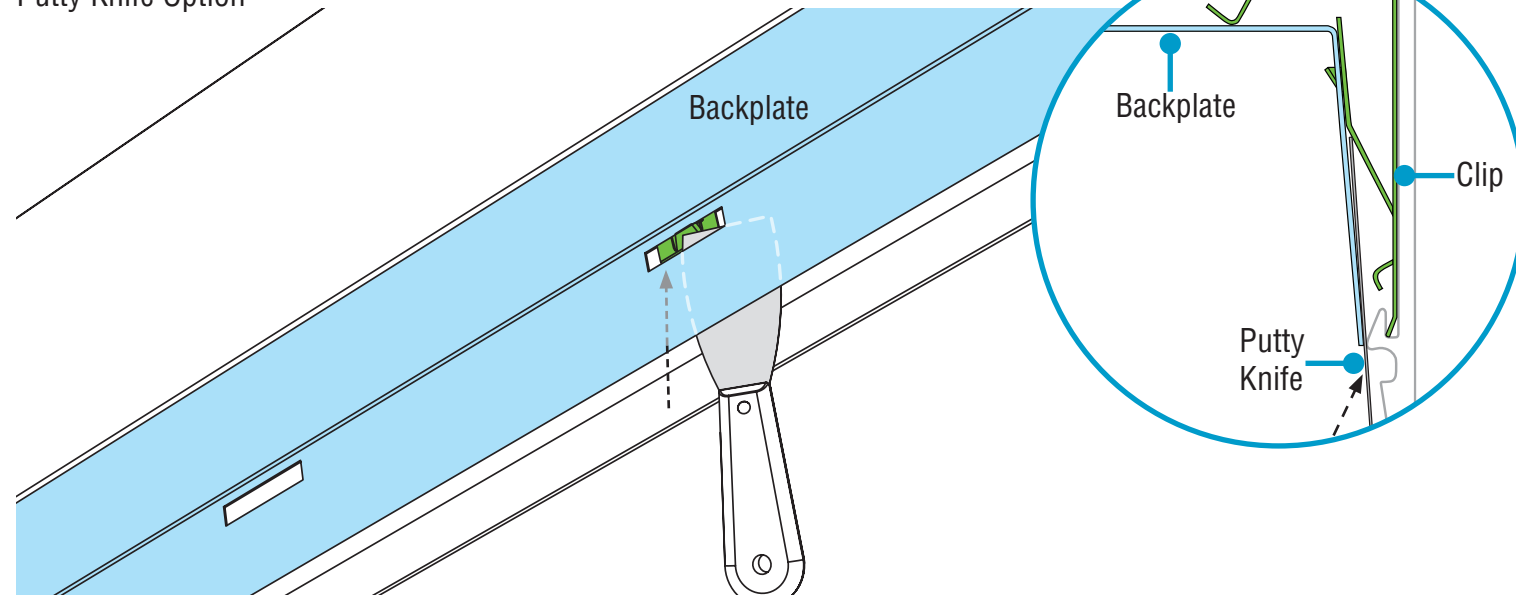

Flathead Screwdriver Option

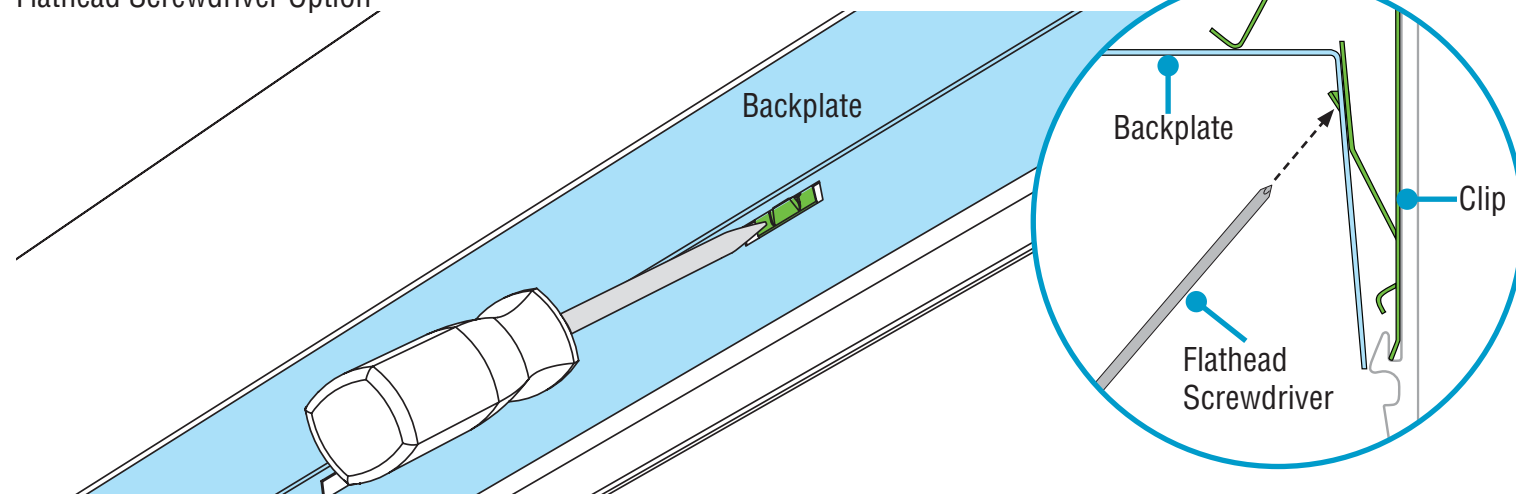

- **NOTE:** For independent luminaires, backplates do not need to be released.
- Release the backplates from clips by sliding the blade of a putty knife behind backplate edges.
- To use a flathead screwdriver, from inside backplate, press end of screwdriver against the clip until the backplate is released.

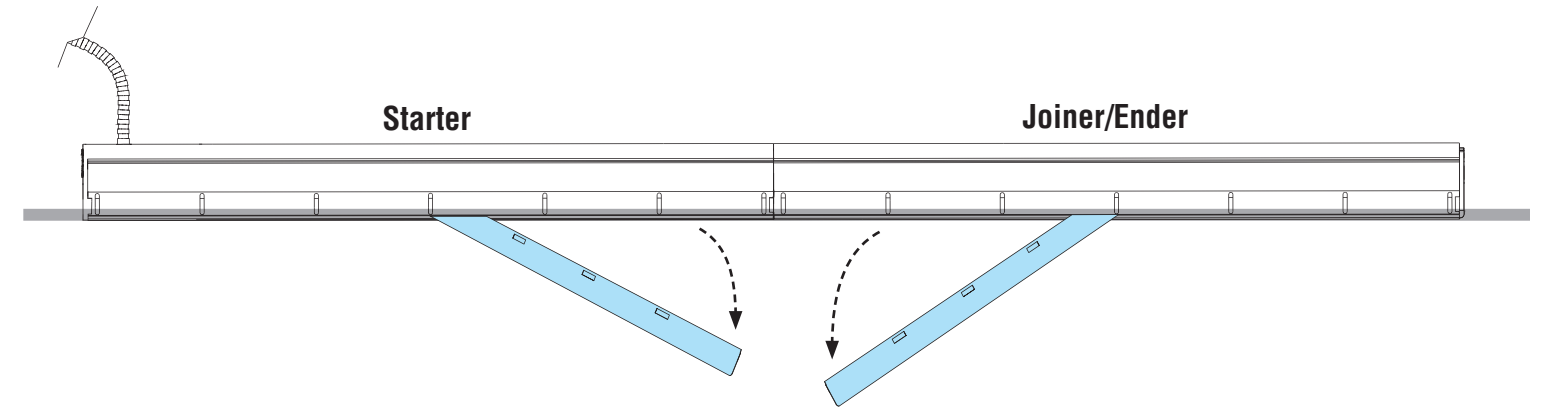

- Carefully rotate backplates out **at the joints only** and let them hang from luminaire bodies.



Effortless
Access

HP-2 / HP-4 / HP-6 Recessed T-Bar Installation Instructions

Step 6 - Securing Luminaire Joints

A. Secure Joint with Yoke Brackets

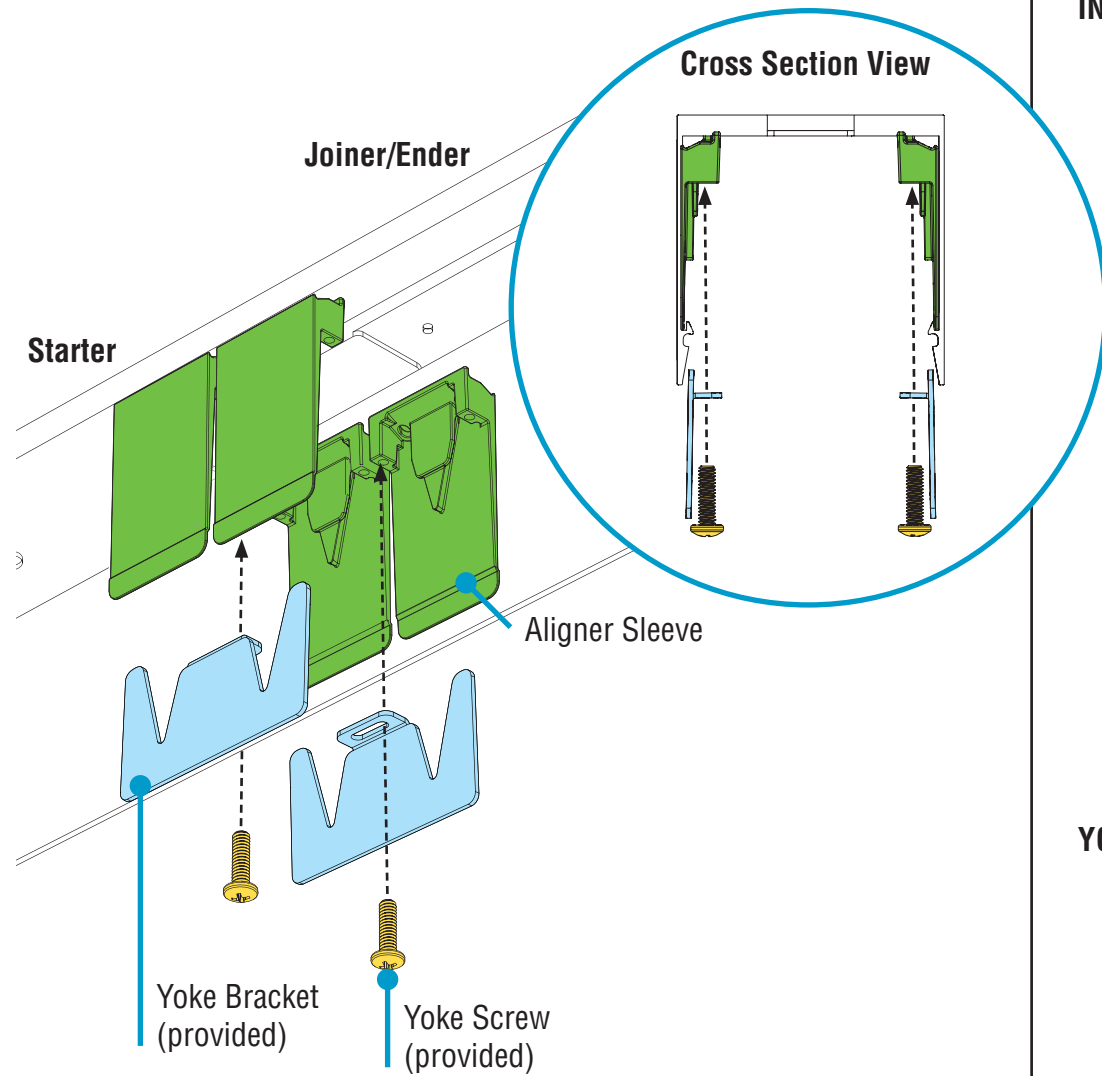

- **FOR SENSOR OR SOCKET:** If luminaire contains a sensor or socket at joint, refer to page 4 of appropriate Addendum before Securing Luminaire Joints.
- Before installing yoke brackets, ensure the joining ends of luminaires meet flush and square.
- **CRITICAL:** Ensure yoke brackets properly engage with aligner sleeves.
- Secure joint by using a screwdriver¹ to tighten yoke screws through yoke brackets and into the aligner sleeves until joint seam of luminaires is closed.

IN ALIGNMENT

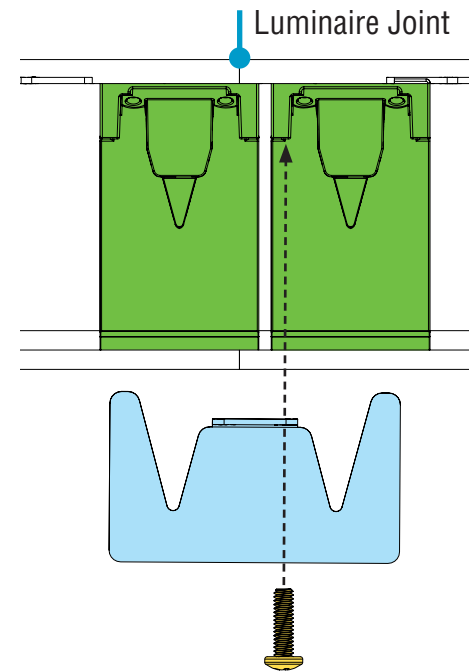

YOKE SCREW ALIGNMENT Bottom-Up View

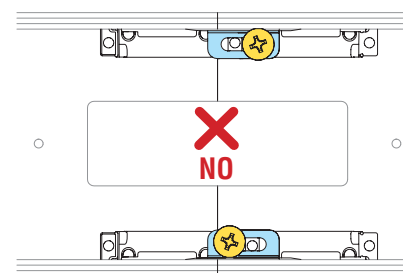

CORRECTLY INSTALLED

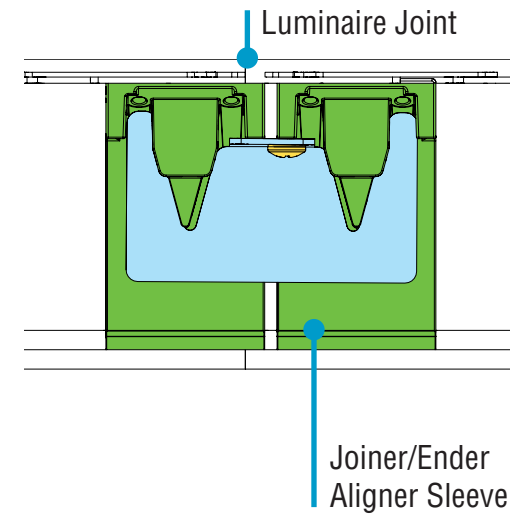

Luminaire Joint Joiner/Ender Aligner Sleeve

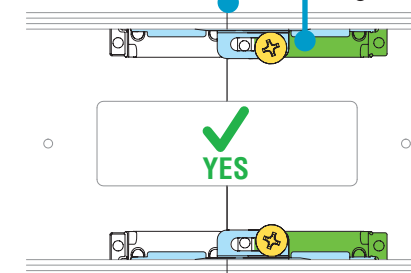

NOTE: Yoke screws should be installed directly across from each other, not diagonally, and in holes furthest from the joint line. One yoke screw per one yoke bracket.

B. Make Electrical Connections

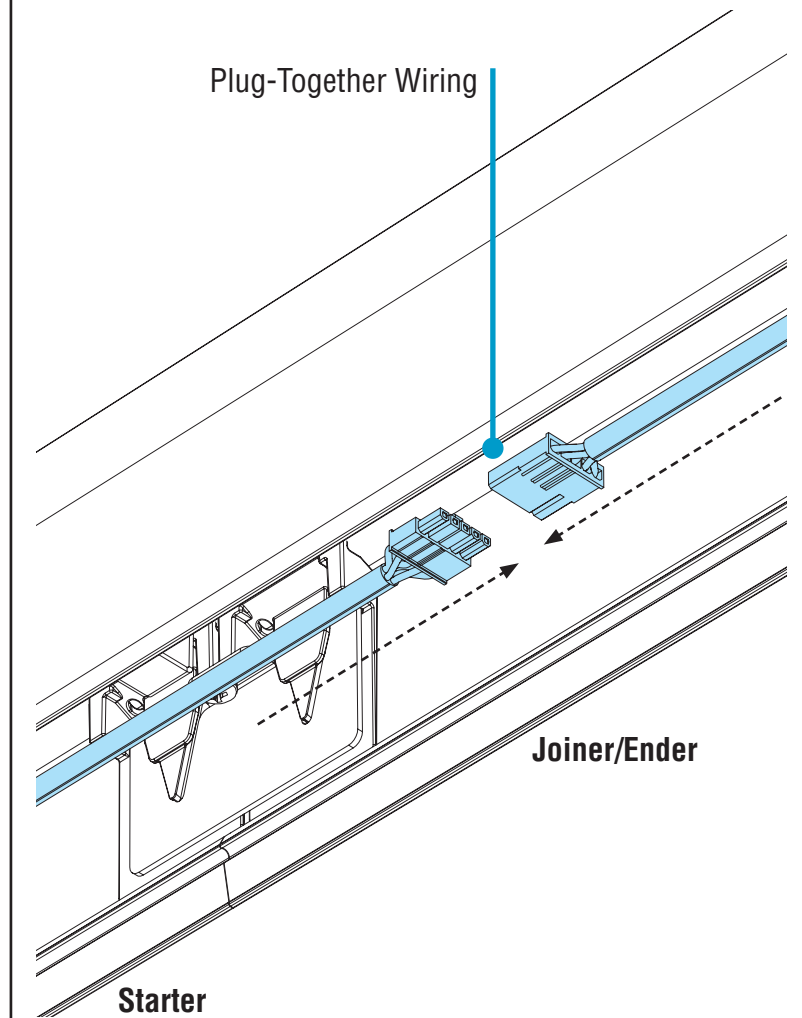

- Connect plug-together wiring.

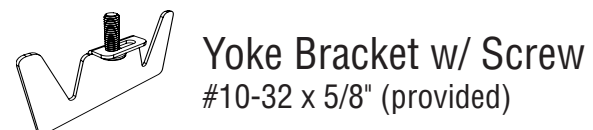

¹ Screwdriver with 6" bit required.

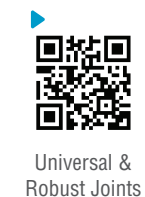

HP-2 / HP-4 / HP-6 Recessed T-Bar Installation Instructions

Step 7 - Closing Luminaires

A. Secure to Structure

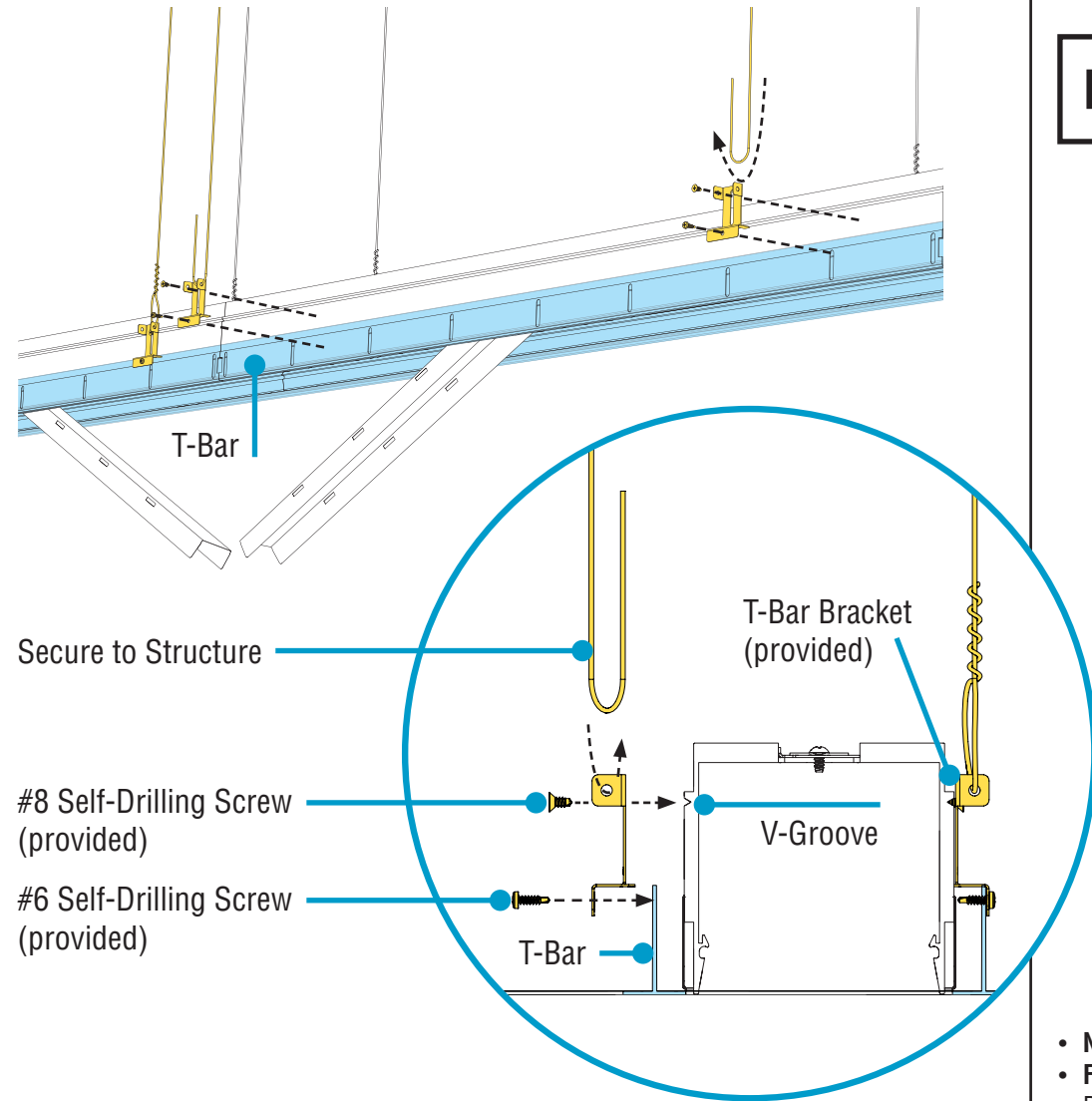

- Use #8 self-drilling screws to mount brackets onto luminaire. Drive the screws into the v-groove screw channel.
- Secure luminaire to building structure using tie-wires, as per code.
- Use #6 self-drilling screws to mount T-Bar brackets to T-Bar ceiling.
- **CAUTION:** Do not over-tighten. Use these screws to control centering of the luminaire between the T-Bars on both sides.

B. Final Step - Replace Backplates & Diffusers or Louvers

NOTE: For White Cross Blade Baffle, refer to Baffle Tether Addendum before installing.

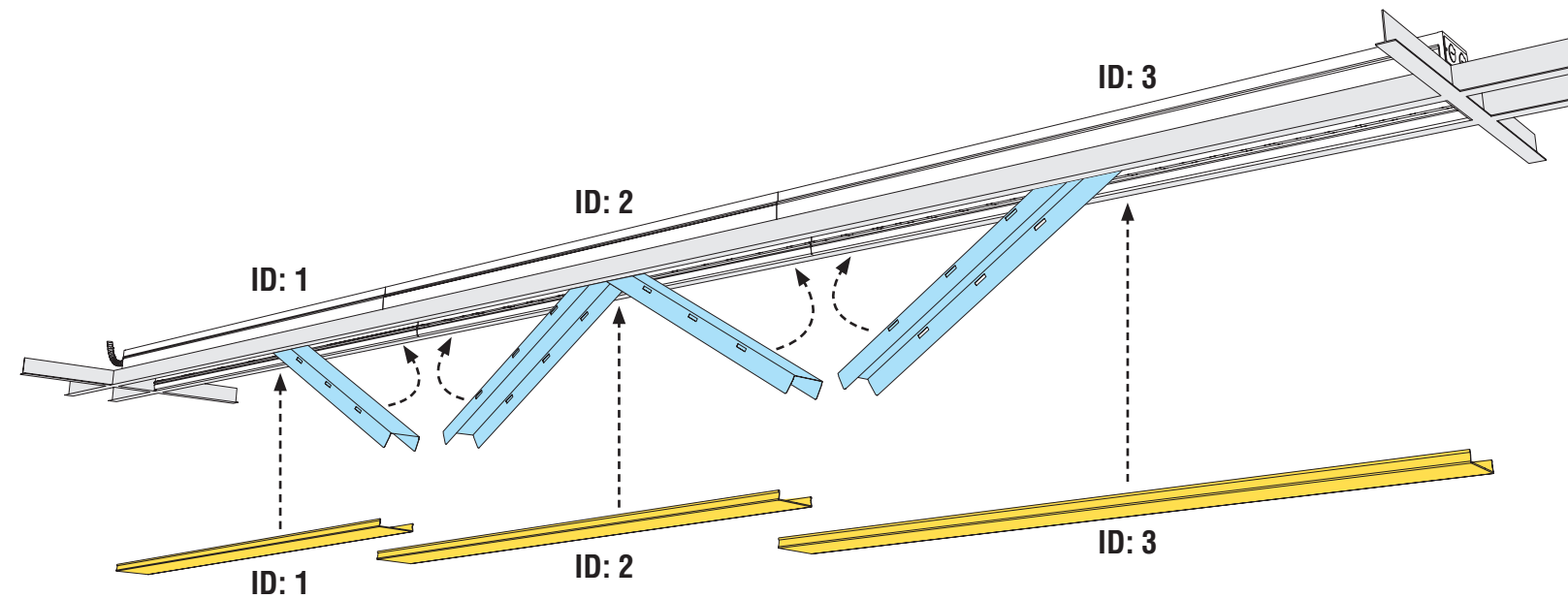

- **NOTE:** If your installation includes a battery backup, please see addendum (98333) that should be included with your kitting package.
- **FOR SENSOR OR SOCKET:** If luminaire contains a sensor or socket at joint, refer to page 5 of appropriate Addendum before Closing Luminaires.
- Reinstall backplates by rotating up into luminaire body and snapping back into clips.
- Remove diffusers or louvers from protective plastic bags.
- **CAUTION:** Wear gloves to keep diffuser or louver surface clean.
- **CRITICAL:** Be sure to install correct diffuser or louver to its corresponding luminaire ID.
- **NOTE:** For White Cross Blade Baffle, refer to Baffle Tether Addendum before installing.
- Install diffusers or louvers into luminaire body, ensuring they snap back into place.
- Turn power on to luminaire.

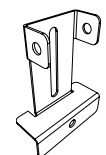

T-Bar Brackets
(provided)



#8 Self-Drilling Screws
(provided)



#6 Self-Drilling Screws
(provided)



Socket Removal
& Installation