

E2

FINELITE[®]
Better Lighting

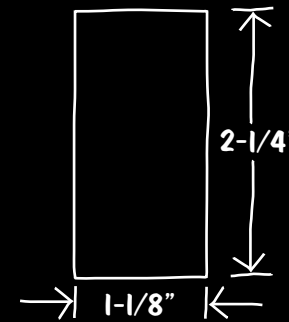
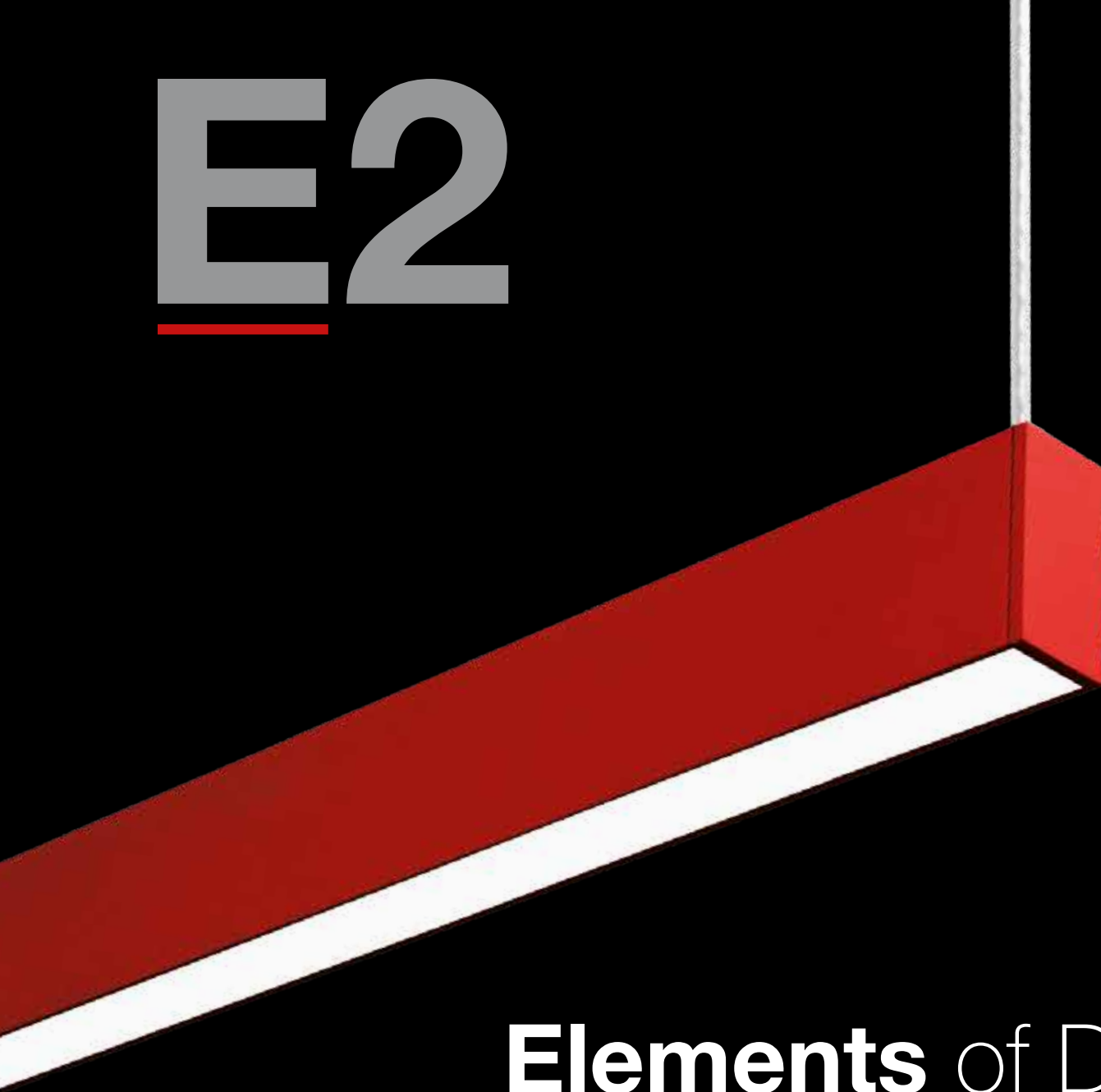

Elements of Design

Minimalist LED Architectural Profile
Linear and Configurations



Easily adjustable off-grid installation and suspension length.

6" or 3" Canopies available (3" shown).

Conductive power cables (standard 4-conductor or 5-conductor with battery backup) every 8'. Joint or independent control of uplight and downlight.

90-degree mitered corners in a single plane.

Minimalist profile indirect/direct luminaire 2-1/4" x 1-1/8".

Multiple unique electrical boxes available to meet all mounting needs. See page 7.

Up to
108
lumens
per watt



Declare 2.0

This product is enrolled in the International Living Future Institute (ILFI) Declare 2.0 Program and is third-party verified.

Tailored output, length, and color for ultimate design control.

E2 Indirect/Direct Linear

The E2 Indirect/Direct (E2-ID) expands the award-winning Elements of Design platform and provides excellent light output with a minimalist architectural profile. Equipped with slender power suspension cabling and multiple driver location options, the E2-ID enables independent switching and dimming controls for uplight and downlight. E2 Linear is now available with optional 3" canopies. See technical sheets for more detail.

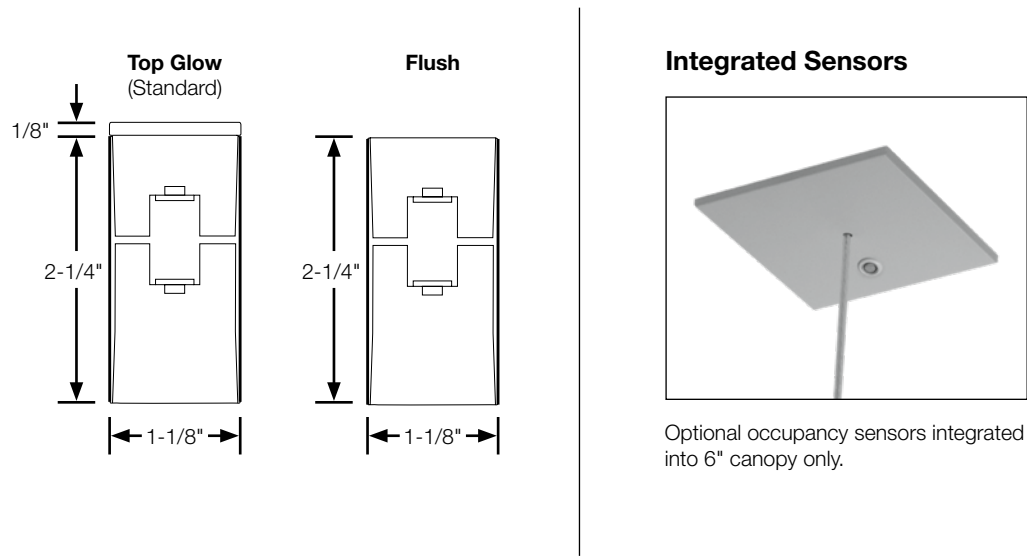

Tailored Lighting | 10-Working-Day Shipping

- **Tailored Output** – Standard (**S**), Boosted Standard (**B**), High (**H**), and Very High (**V**).
- **Tailored Length** – Lengths greater than 2' in increments down to 1/16" ($\pm 1/32$ ").
- **Tailored Color*** – 3000K, 3500K, 4000K CCT; 80+ or 90+ CRI.

* Tunable white is not available

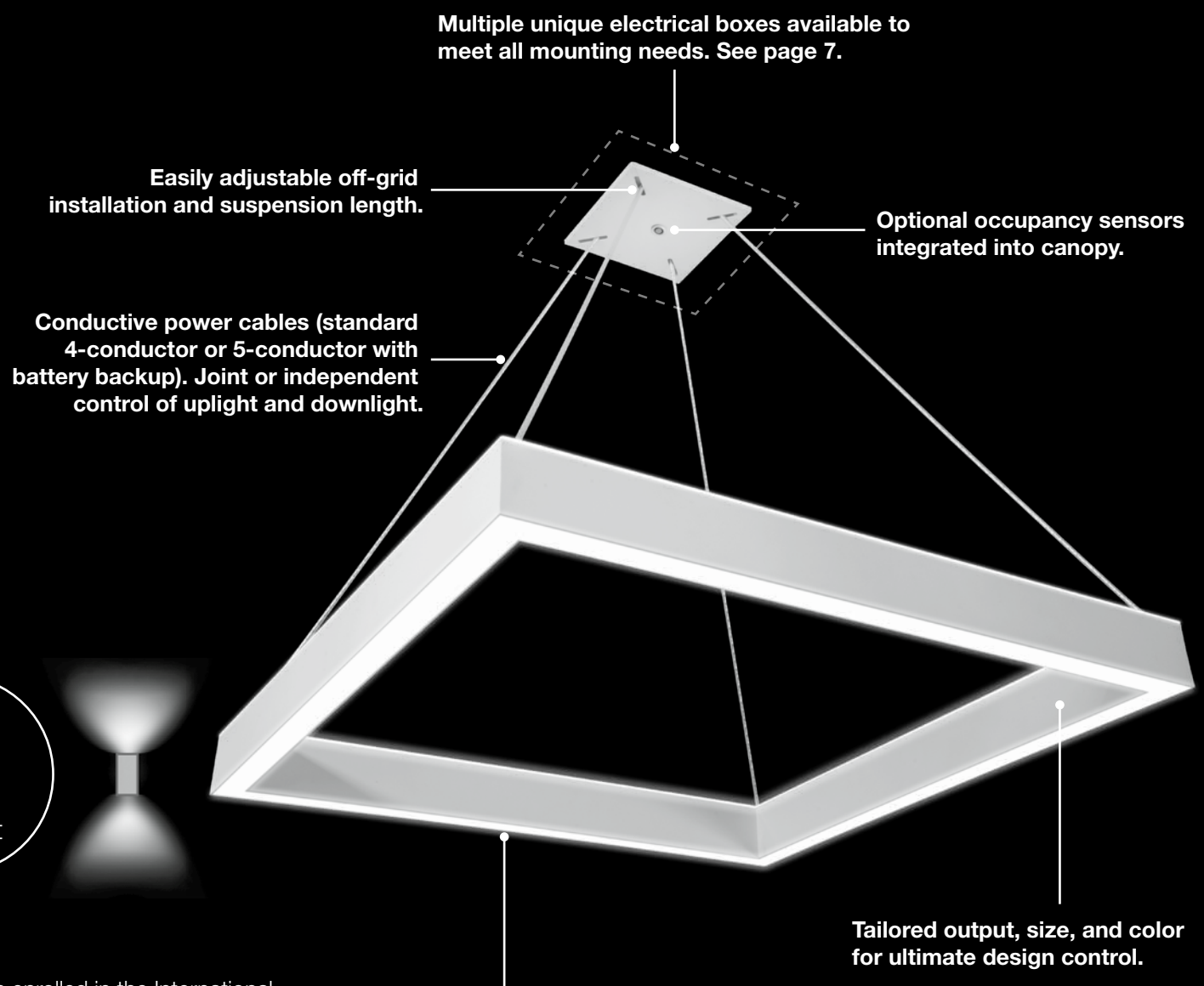

Multiple unique electrical boxes available to meet all mounting needs. See page 7.

Easily adjustable off-grid installation and suspension length.

Optional occupancy sensors integrated into canopy.

Conductive power cables (standard 4-conductor or 5-conductor with battery backup). Joint or independent control of uplight and downlight.

Up to
108
lumens
per watt

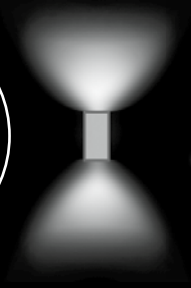

Tailored output, size, and color for ultimate design control.

Minimalist profile indirect/direct luminaire 2-1/4" x 1-1/8".

Declare 2.0

This product is enrolled in the International Living Future Institute (ILFI) Declare 2.0 Program and is third-party verified.

E2 Indirect/Direct Configuration

The elements platform can be specified in linear runs or unique configurations to meet the specific needs of your space. E2 configurations flow from a sleek canopy on powered suspension cables and can be specified in predetermined sizes from 2'x2' to 4'x4' squares and up to 1'x8' rectilinear forms.

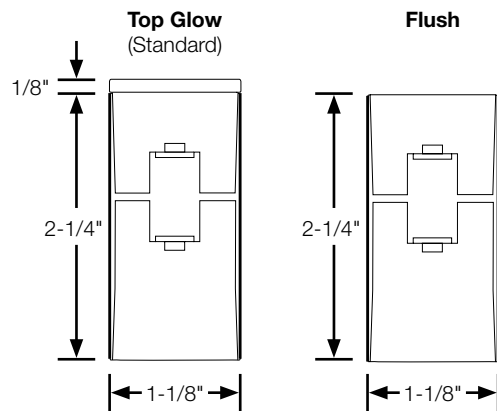

1'x8' Installation

The E2 1'x8' is installed using two power supply boxes (one at each end and directly above the luminaire).

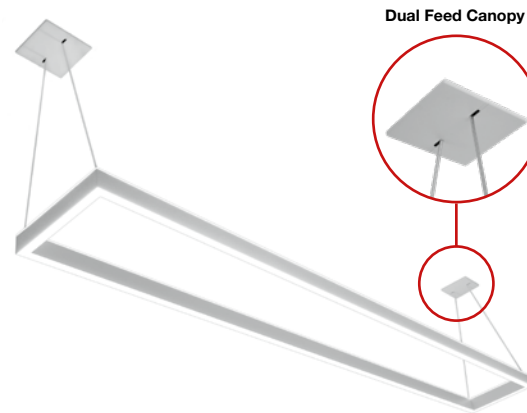

Tailored Lighting | 10-Working-Day Shipping

- **Tailored Output** – Standard (**S**), Boosted Standard (**B**), High (**H**), and Very High (**V**).
- **Tailored Sizes** – Can be specified from 1'x2', 1'x4', 1'x8', 2'x2', 2'x3', 2'x4', 3'x3', 3'x4', and 4'x4'.
- **Tailored Color*** – 3000K, 3500K, 4000K CCT; 80+ or 90+ CRI.

* Tunable white is not available

Performance

Linear & Configuration

↑ Flush / ↓ Flush Diffuser (E2-ID-L-4'-V-V-835-F-F)

Very High Output / Very High Output - 4' Luminaire

Distribution: 61% Up (V) / 39% Down (V)

Efficacy: 99 lumens per watt

Uplight: 2250 lumens (563 lumens/foot)

Downlight: 1440 lumens (360 lumens/foot)

Total luminaire output: 3690 lumens (923 lumens/foot)

37.2 watts (9.3 watts/foot)

CCT: 3500K; CRI: 80

ITL LM79 Report 89277

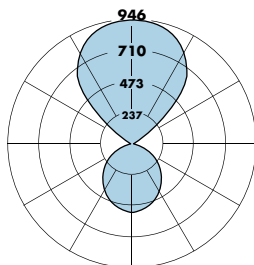

	↑ Indirect		↓ Direct	
Total Light Output, 3500K, 80 CRI (Lumens) - 4' Luminaire				
	↑S*	↑B*	↑H*	↑V**
↓S*	1511 [↑61% 39%↓]	1747 [↑66% 34%↓]	2339 [↑75% 25%↓]	2839 [↑79% 21%↓]
↓B*	1662 [↑55% 45%↓]	1899 [↑61% 39%↓]	2491 [↑70% 30%↓]	2991 [↑75% 15%↓]
↓H*	2041 [↑45% 55%↓]	2278 [↑51% 49%↓]	2870 [↑61% 39%↓]	3370 [↑67% 33%↓]
↓V*	2361 [↑33% 67%↓]	2598 [↑45% 55%↓]	3190 [↑55% 45%↓]	3690 [↑61% 39%↓]

Light Output, 3500K, 80 CRI (Lumens Per Foot)				
	↑S*	↑B*	↑H*	↑V**
↓S*	378	437	585	710
↓B*	416	475	623	748
↓H*	510	569	718	843
↓V*	590	649	798	923

Power, 3500K, 80 CRI (Watts Per Foot)				
	↑S*	↑B*	↑H*	↑V**
↓S*	3.8	4.3	5.5	6.6
↓B*	4.3	4.8	6.0	7.0
↓H*	5.5	6.0	7.2	8.3
↓V*	6.6	7.0	8.3	9.3

Efficacy, 3500K, 80 CRI (Lumens Per Watt)				
	↑S*	↑B*	↑H*	↑V**
↓S*	99	101	106	108
↓B*	96	99	104	106
↓H*	93	95	100	102
↓V*	90	92	97	99

S - Standard Output, B - Boosted Standard Output, H - High Output, V - Very High Output

* Family Correlation based on 4' luminaire 3500K Very High Output (V) test – 120V

** Correlation based on ITL report: 89277

E2 Electrical Box Options



Low Profile T-Bar Power Supply Box 6" Canopy (P01)

Dimensions – 10-1/8"W x 16-1/8"L x 1-11/16"D
Configuration Availability – 1'x2', 1'x8'¹, 2'x2'

- T-Bar only
- Two drivers maximum per box (illuminates up to 8')
- Includes easy leveling system from below ceiling
- Access to drivers from above ceiling for simple maintenance
- (7) 1/2" feed knockouts available to connect building power
- Optional occupancy sensor located in canopy for a clean aesthetic



Low Profile T-Bar Power Supply Box 3" Canopy (P04)²

Dimensions – 10-1/8"W x 16-1/8"L x 1-11/16"D

- Small aperture for clean ceiling line
- T-Bar only
- Two drivers maximum per box (illuminates up to 8')
- Includes easy leveling system from below ceiling
- Access to drivers from above ceiling for simple maintenance
- (7) 1/2" feed knockouts available to connect building power
- Due to size restrictions, P04 does not accommodate integral sensors.



Large Capacity Power Supply Box 6" Canopy (P02)

Dimensions – 10"W x 23"L x 4"D
Configuration Availability – 1'x2', 1'x4', 1'x8'¹, 2'x2', 2'x3', 2'x3', 3'x3', 3'x4', 4'x4'

- T-Bar or Drywall ceiling compatible³
- Four drivers maximum per box (illuminates up to 16') or two drivers (illuminates up to 8') and one EM battery pack for egress (illuminates 4' only)
- Includes easy leveling system from below the ceiling
- Access to drivers from below ceiling to reduce maintenance time
- (4) 1/2" feed knockouts available to connect building power
- Optional occupancy sensor located in canopy for a clean aesthetic



Large Capacity Power Supply Box 3" Canopy (P05)²

Dimensions – 10"W x 23"L x 4"D

- Small aperture for clean ceiling line
- T-Bar only
- Access to drivers from above ceiling only
- Four drivers maximum per box (illuminates up to 16')
- Includes easy leveling system from below the ceiling
- (4) 1/2" feed knockouts available to connect building power
- Due to size restrictions, P05 does not accommodate integral sensors.



Retrofit Power Supply Box 6" Canopy (P03)

Dimensions – 5"W x 14-3/8"L x 8-3/4"D
Configuration Availability – 1'x2', 2'x2'

- T-Bar or Drywall ceiling compatible³
- Two drivers maximum per box (illuminates up to 8')
- Includes easy leveling system from below ceiling
- Access to drivers from below ceiling to reduce maintenance time
- (4) 1/2" feed knockouts available to connect building power
- Optional occupancy sensor located in canopy for a clean aesthetic



Splice Box 6" Canopy (S01)

Dimensions – 5"W x 5"L x 2-3/8"D

- T-Bar or Drywall ceiling compatible³
- Includes easy leveling system from below ceiling



Splice Box 3" Canopy (S02)²

Dimensions – 5"W x 5"L x 2-3/8"D

- T-Bar or Drywall ceiling compatible³
- Includes easy leveling system from below ceiling

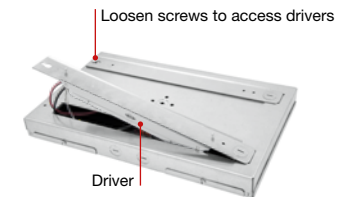

Easy Access To Driver Low Profile T-Bar Power Supply Box

Drivers are easily accessed from above ceiling. Bar hangers ordered separately.

¹ 1'x8' is installed using two power supply boxes (one at each end of the luminaire)

² Available with linear only

³ Contact factory for open ceiling applications

E2 Electrical Box Specifications

Linear

Electrical Box Specifications (For more details, refer to www.finelite.com for the Electrical Box Specification Guide.)

A. 24' run with Low Profile T-Bar Power Supply Boxes (P01). Two drivers in each box. T-Bar ceiling.

Low Profile T-Bar Power Supply Box (P01)



B. 24' run with Large Capacity Power Supply Boxes (P02). Two drivers and one battery backup* in first box. Drywall or T-Bar ceiling.

Large Capacity Power Supply Box (P02)

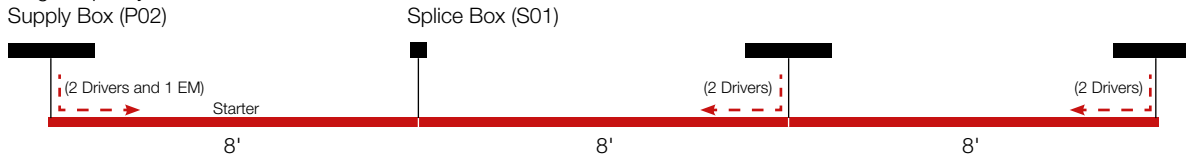

C. 24' run with Retrofit Power Supply Boxes (P03). Two drivers in each box. Drywall or T-Bar ceiling.

Retrofit Power Supply Box (P03)

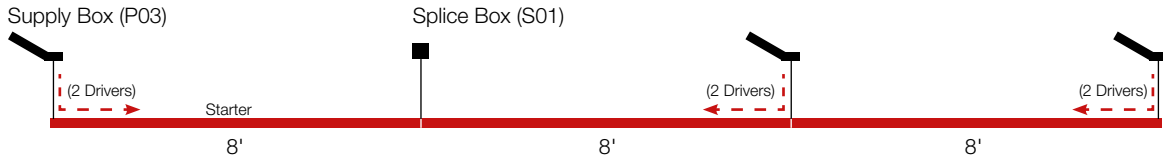

D. 32' run with Large Capacity Power Supply Boxes (P02). Four drivers in each box. Drywall or T-Bar ceiling.

Splice Box (S01)

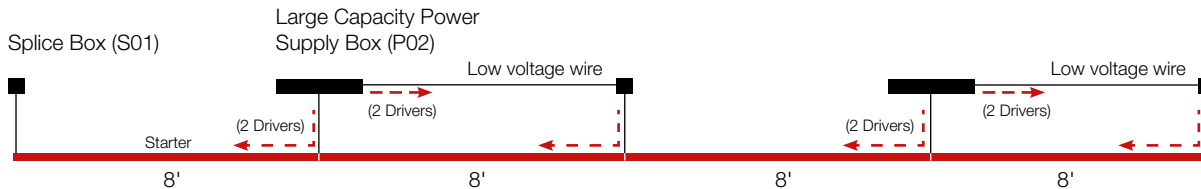

* **Note:** Standard battery backup section is for 4' downlight only.

Easy Leveling System On All Boxes

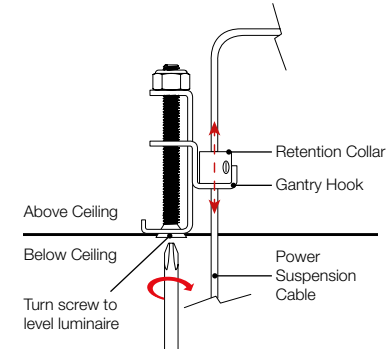

3" Canopy

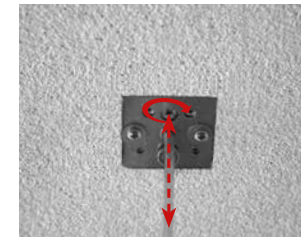

6" Canopy



Watch Video



Scan this QR code with your mobile phone or tablet.

E2-ID includes a patent pending leveling system for simple leveling adjustment and a consistent luminaire sightline.

Configuration

Electrical Box Specifications (For more details, refer to www.finelite.com for the Electrical Box Specification Guide.)

Low Profile T-Bar Power Supply Boxes (P01)
(T-Bar Ceiling)

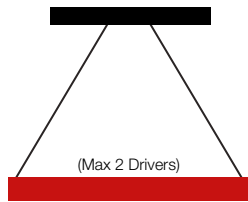

1'x2', 1'x8'¹, 2'x2'

Retrofit Power Supply Boxes (P03)
(Drywall or T-Bar Ceiling)

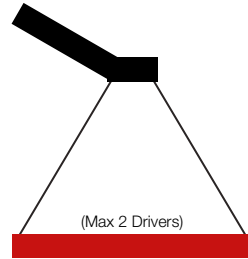

1'x2', 2'x2'

Large Capacity Power Supply Boxes (P02)
(Drywall or T-Bar Ceiling)

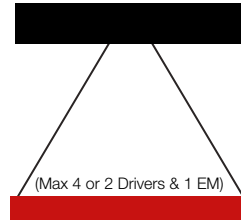

1'x2', 1'x4', 1'x8'¹, 2'x2', 2'x3',
2'x4', 3'x3', 3'x4', 4'x4'

¹ 1'x8' is installed using two power supply boxes (one at each end of the luminaire).

Easy Installation

Specially designed mounting hardware and a unique canopy design makes E2 Configuration easy to install, level, and maintain. Designed to mount cleanly in the center of ceiling tile or sheetrock ceiling.

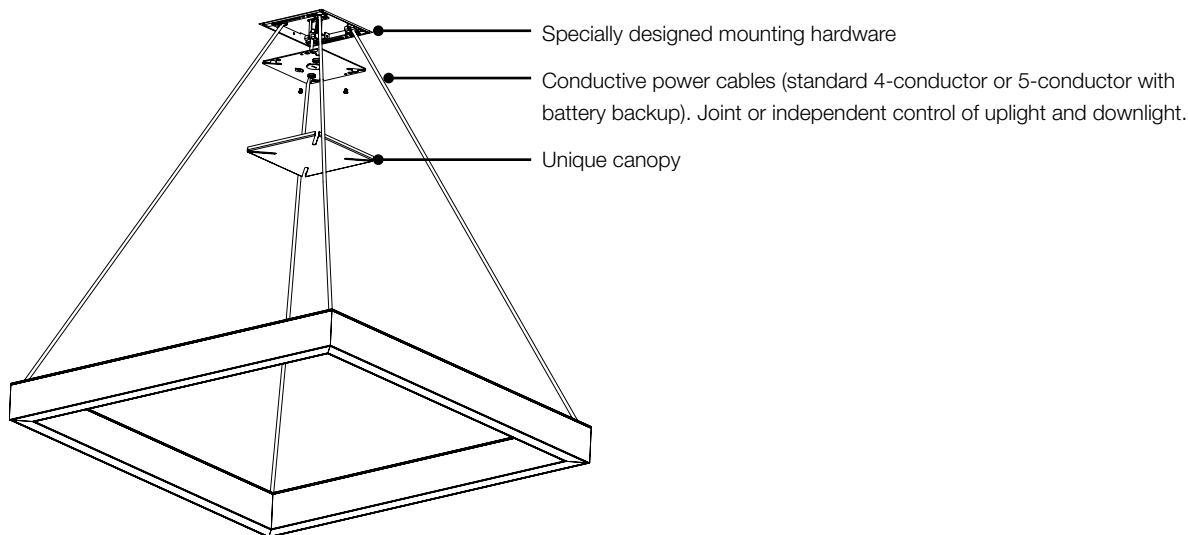

Patent Pending

Easy Leveling System On All Boxes

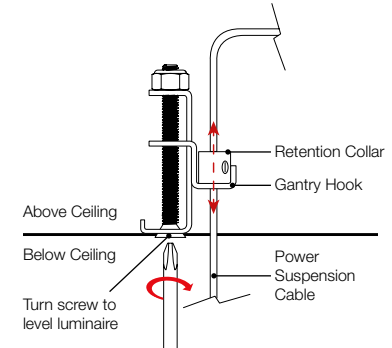

2 Leveling Screws (1'x8' Only)

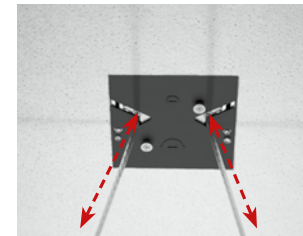

4 Leveling Screws

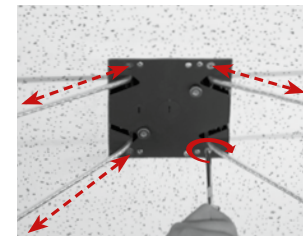

Watch Video



Scan this QR code with your mobile phone or tablet.

E2-ID includes a patent pending leveling system for simple leveling adjustment and a consistent luminaire sightline.

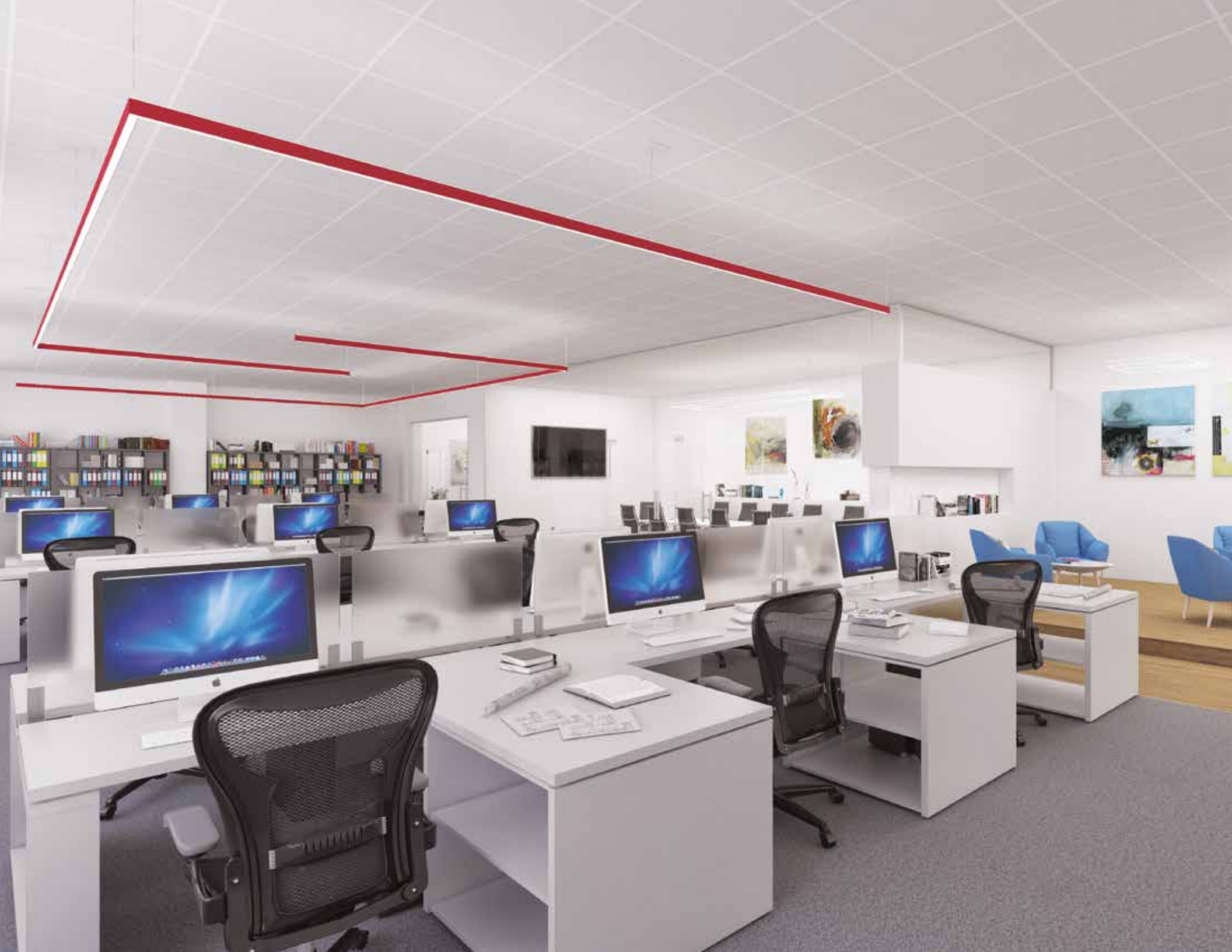

E2 Application Data

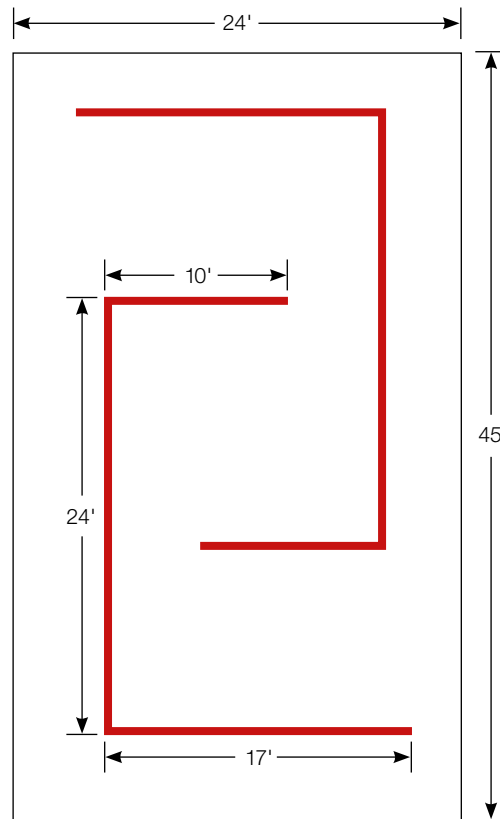

	E2-ID-L-B-B-835
Average Light Level on Desktop (Footcandles)	37
Average to Minimum on Desktop (Illuminance)	2:1
Energy Consumption (Lighting Power Density)	0.45 W/ft ²
Room Size (Area)	24' x 45'

- Ceiling Height: 10'0"
- Luminaire Height: 8'0" AFF to bottom of luminaire
- Reflectance: 80/50/20
- Light levels are initial

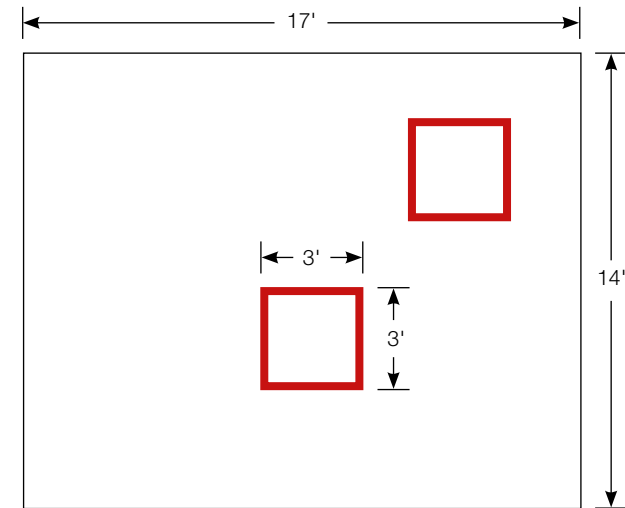

	E2-ID-3x3-B-B-835
Average Light Level at Workplane (Footcandles)	29
Energy Consumption (Lighting Power Density)	0.48 W/ft ²
Room Size (Area)	17' x 14'

- Ceiling Height: 10'0"
- Luminaire Height: 8'0" AFF to bottom of luminaire
- Reflectance: 80/50/20
- Light levels are initial

FINELITE[®]

Better Lighting

The Finelite LED Difference



10-year performance-based warranty



90% of initial light output at 100,000+ hours



Dimming standard



Replaceable LED light arrays

Finelite Commitment To You



Ships in 10 working days for standard orders



Focus on sustainability



Buy American Act of 2009 Compliant